

EMCO

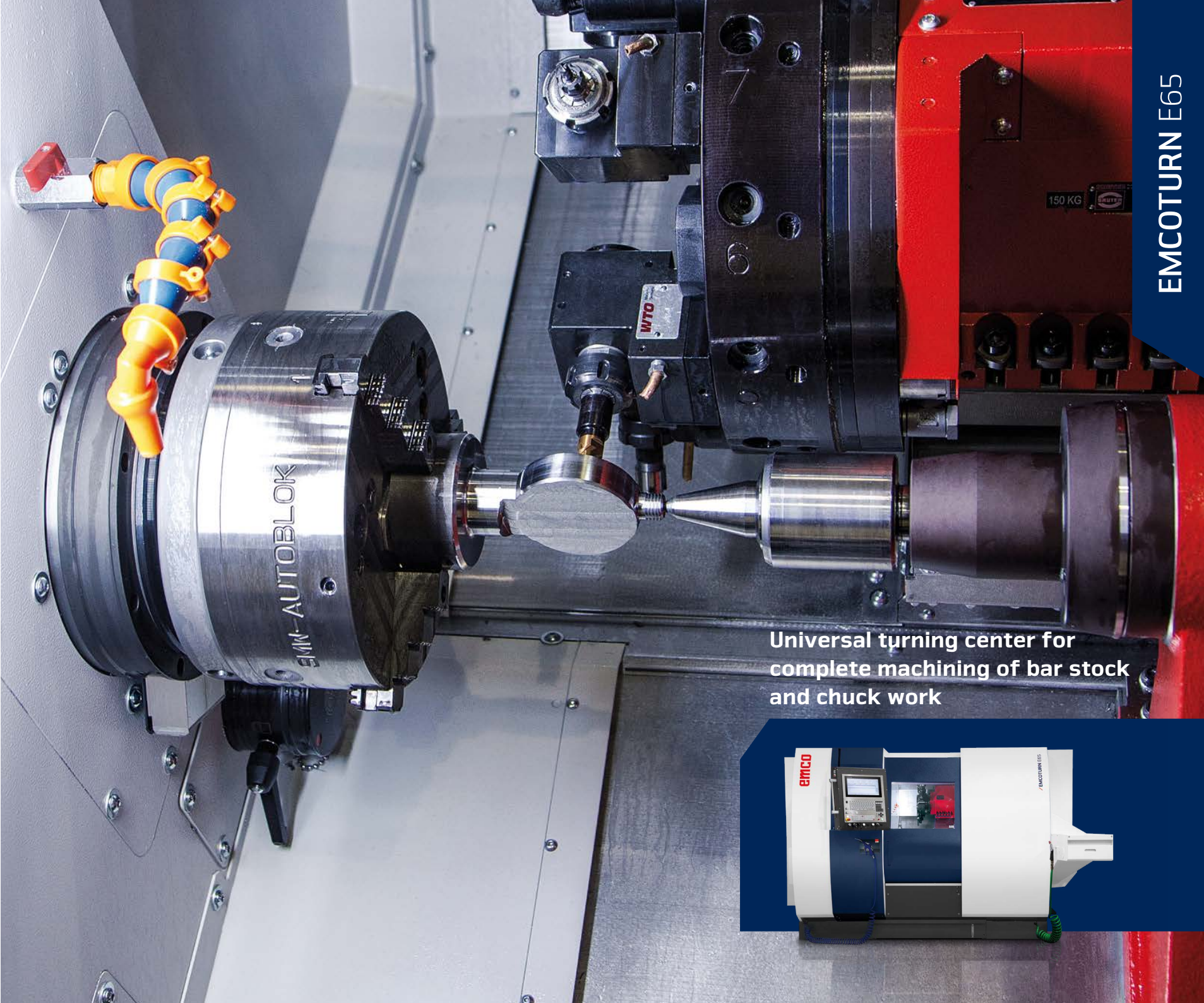

Universal turning center for complete machining of bar stock and chuck work



EMCOTURN E65

EMCOTURN E65 IN THE TAILSTOCK VERSION

The EMCOTURN E65 with tailstock underwent a complete redesign. As of now, it may be used with a Y-axis for the processing of complex turned/milled parts. A reduction in the auxiliary process times was achieved through increased rapid traverse speeds. There are two spindle sizes available: one with a bar capacity of up to 65 mm and another with up to 95 mm. Workpieces with a diameter of up to 95 mm may thus be automatically fed and processed by means of a short bar feeder.



Connection part
(Stainless steel)

1 WORK AREA

- / Easily accessible workspace
- / Optimal chip flow
- / Guideways fully covered

2 TOOL TURRET

- / 12-position VDI 30 (VDI 40) axial
- / 12 driven tool stations
- / Servo-controlled
- / Rigid tapping
- / Polygonal turning, gear-cutting, etc.

3 Y-AXIS

- / Travel +/- 40 mm (1.6")
- / 90° implemented in the machine construction
- / Large distance between guide rails
- / Stable and compact construction without restrictions

4 MAIN SPINDLE

- / High drive performance
- / Thermoresistant construction
- / Large speed range
- / A2-6 (A2-8) spindle connection
- / Bar capacity Ø 65 (95) mm

5 CONTROL

- / State-of-the-art control technology
- / FANUC OiTF / 15" incl. Manual Guide i
- / SINUMERIK 828D / 15" incl. Shop Turn
- / HEIDENHAIN CNC PILOT 640 / 15,6" incl. Smart Turn
- / 90° pivot

6 MACHINE COVER

- / All-round protection from chips
- / 100% coolant retention
- / Large safety glass window in door
- / Clear view of the work area
- / Built-in buttons for operator convenience

7 MACHINE DESIGN

- / Compact machine design, requiring a comparatively small footprint

8 HYDRAULIC UNIT

- / Hydraulic system
- / Lateral arrangement of the hydraulic valves
- / Very good accessibility
- / Automatic setting of the pressure switches
- / Programmable clamping pressure – optional



Machine with optional equipment

EMCOTURN E65 IN THE COUNTER SPINDLE VERSION

The EMCOTURN E65 S with counter spindle, radial turret and optional Y-axis is the entry-level machine for the complete processing of turned/milled parts. Thanks to the fully-developed counter spindle, it is possible to turn, mill and drill workpieces on both sides. The counter spindle may also be used as a tailstock for supporting long workpieces. If required, large shaft parts may even be unloaded through the counter spindle.



Chain wheel adapter
(Aluminium)

1 WORK AREA

- / Easily accessible workspace
- / Optimal chip flow
- / Guideways fully covered

2 TOOL TURRET

- / 12-position VDI 30 (VDI 40) radial
- / 12 driven tool stations
- / Servo-controlled
- / Rigid tapping
- / Polygonal turning, gear-cutting, etc.

3 COUNTER SPINDLE

- / Complete machining of components
- / Incl. C-axis for milling operations
- / Incl. part ejector
- / Incl. flushing
- / Optionally available with a passage for unloading long shaft parts

4 Y-AXIS

- / Travel +/-40 mm (1.6")
- / 90° implemented in the machine construction
- / Large distance between guide rails
- / Stable and compact construction without restrictions

5 EMCO SHORT BAR LOADER SL 1200

- / Bar diameter 8 - 95 mm
- / Bar length 250 - 1200 mm
- / Material storage area 560 x 1210 mm
- / Dimensions 1700 x 1250 mm
- / 400 mm travel range

6 CONTROL

- / State-of-the-art control technology
- / FANUC 0iTF / 15" incl. Manual Guide i
- / SINUMERIK 828D / 15" incl. Shop Turn
- / HEIDENHAIN CNC PILOT 640 / 15,6" incl. Smart Turn
- / 90° pivot

7 MACHINE COVER

- / All-round protection from chips
- / 100% coolant retention
- / Large safety glass window in door
- / Clear view of the work area
- / Built-in buttons for operator convenience

8 MACHINE DESIGN

- / Compact machine design, requiring a comparatively small footprint

9 HYDRAULIC UNIT

- / Hydraulic system
- / Lateral arrangement of the hydraulic valves
- / Very good accessibility
- / Automatic setting of the pressure switches
- / Programmable clamping pressure – optional

10 FINISHED PARTS CONVEYOR

- / Large storage capacity
- / Automatic indexing
- / incl. chip drawer

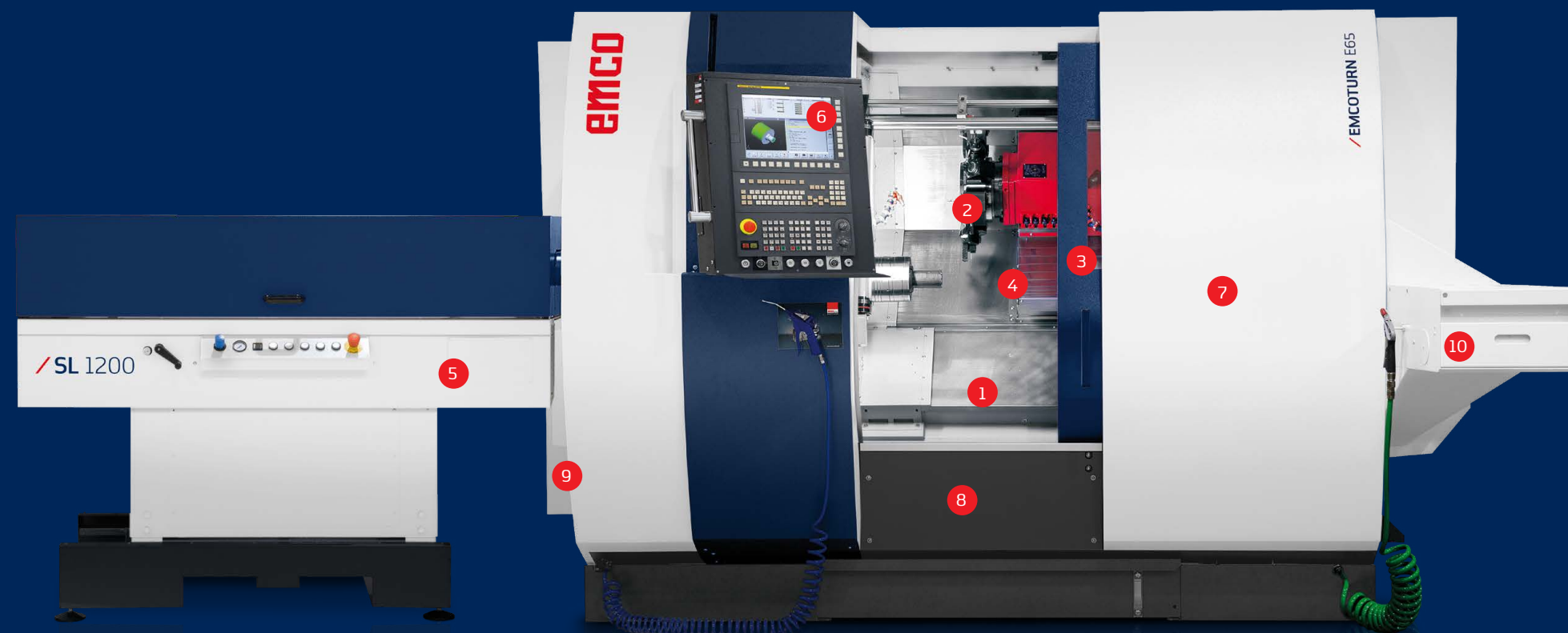

Machine with optional equipment

CONSTRUCTION

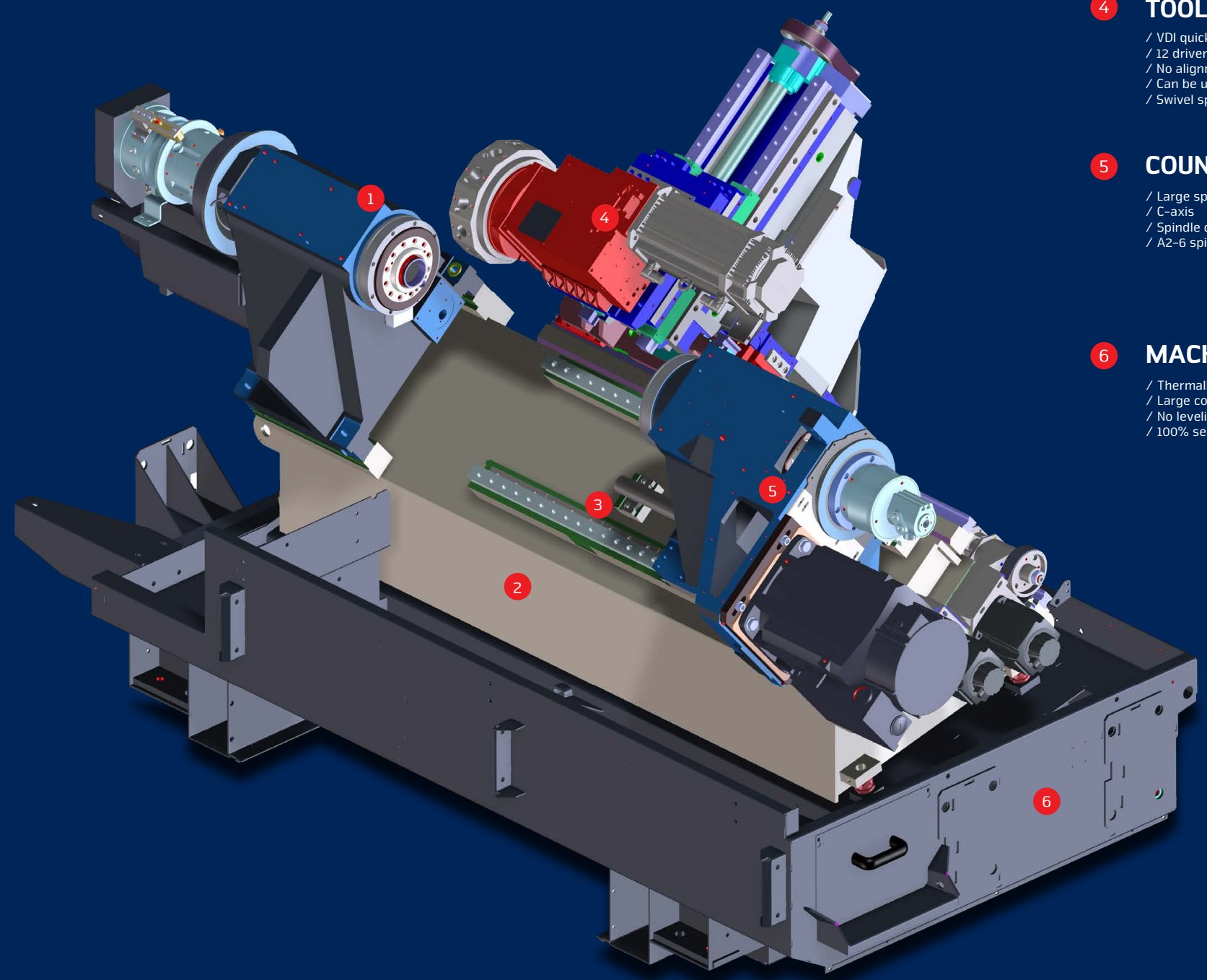

1 MAIN SPINDLE
 / High drive power
 / Compact, thermostable construction
 / Large speed range
 / A2-6 (A2-8) spindle connection
 / Bar capacity diameter 65 (95) mm

2 MACHINE BASE
 / Extremely stiff welded steel fabrication
 / Compact structure
 / Very high thermostability
 / Filled with vibration-absorbing material

3 ROLLER GUIDES
 / In all linear axes
 / Preloaded
 / No backlash in any direction of force
 / High rapid motion speed
 / No wear
 / Minimal lubrication

4 TOOL TURRET
 / VDI quick change system
 / 12 driven tool stations
 / No alignment of the tool holder
 / Can be used on both spindles
 / Swivel speed adjustable with override

5 COUNTER SPINDLE
 / Large speed range
 / C-axis
 / Spindle clamp
 / A2-6 spindle connection

6 MACHINE STAND
 / Thermally isolated from the machine base
 / Large coolant container that is easy to clean
 / No leveling necessary
 / 100% sealed against coolant leaks

VALIDATED QUALITY

ROUNDNESS AND SURFACE QUALITY

Material:	Brass (Cu Zn 40 Pb 2)
Cutting tool:	Carbide insert CCGX 09 T3 04-AL
Turning diameter:	∅ 55 mm
Cutting speed:	300 m/min
Feed rate:	0.025 mm/rev
Cutting depth:	0.03 mm

AS MEASURED ...*

Roundness:	0.45 μm
Surface finish:	Ra = 0.163 μm

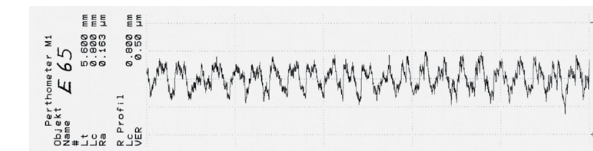

REPEAT ACCURACY

Material:	Steel – 16 Mn Cr 5
Turning diameter:	∅45 h6
Tolerance:	16 μm
Spindle speed:	2000 rpm
Feed rate:	0.08 mm/rev
Cutting depth:	0.2 mm

LONG TERM MACHINING ACCURACY: 4 μm

AS MEASURED ...*

Range:	4 μm
Cm value:	2.57

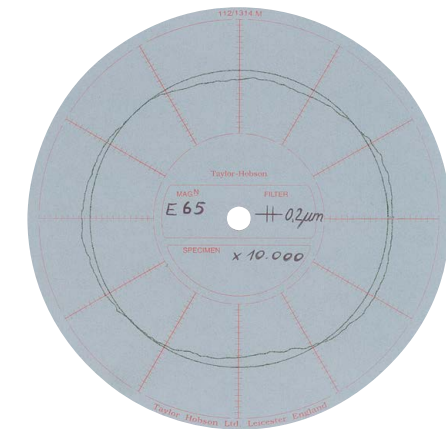
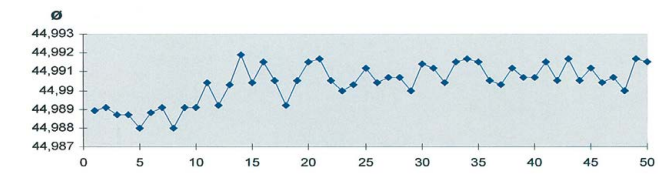

*...Due to a series of factors, such as warm-up cycles, speeds, feed rates, tools, coolants, materials, ambient temperature, etc., the actual results may differ from those specified above.

TECHNICAL HIGHLIGHTS

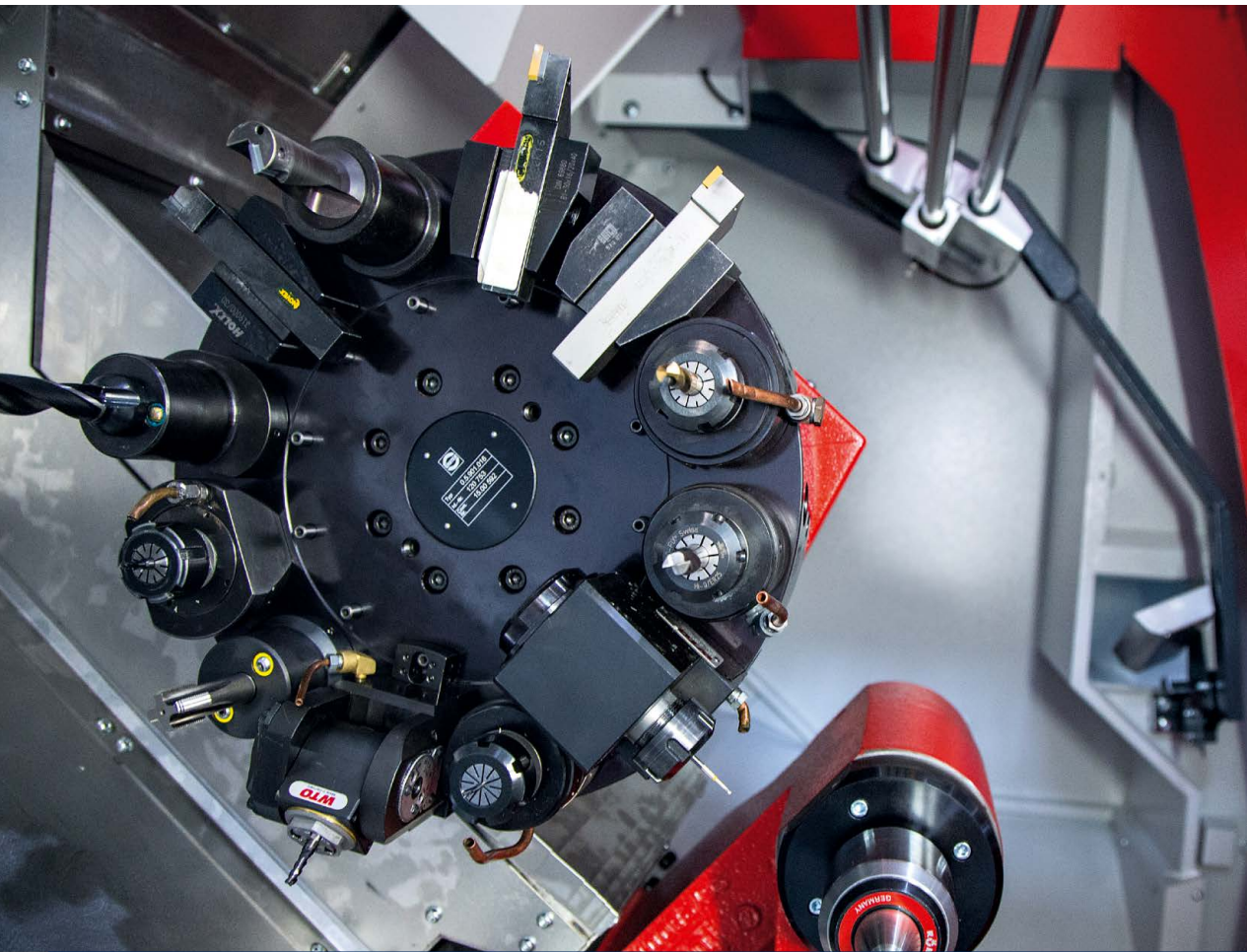

WORK AREA

The spacious work area offers room for a large number of tools on the tool turret, thus also ensuring a continuous chip flow during virtually unmanned production. During the machining process, the parts catcher is in its original position, which is why it does not restrict the machining process in any way whatsoever.

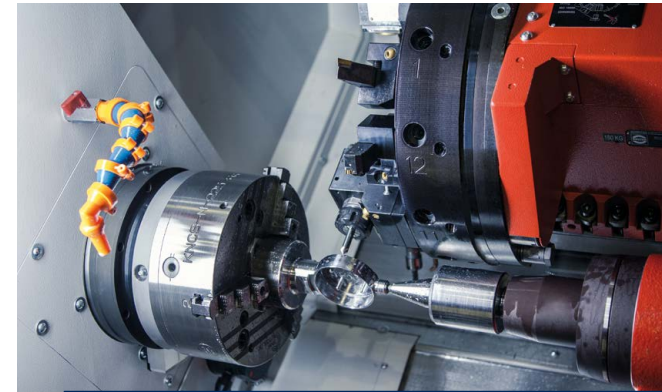

MAIN SPINDLE

There are two spindle sizes available for selection: one with a capacity of up to 65 mm with A2-6 and another with a capacity of up to 95 mm with A2-8. Both allow a wide range of clamping devices, such as collet chucks, 3-jaw chucks or face drivers, to be attached. For complex milling operations, the spindle can also be used for interpolation contouring or be clamped in any position.

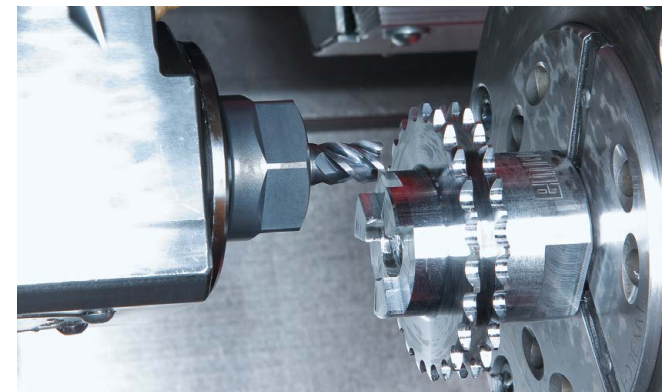

COUNTER SPINDLE

The counter spindle is available for complete workpiece machining. Turning, milling and drilling operations can thus also be performed on the back of the workpieces. The concentric takeover of the workpieces offers another advantage: the possibility to maintain a very high level of accuracy with regard to the coaxiality, concentricity and angular position values.

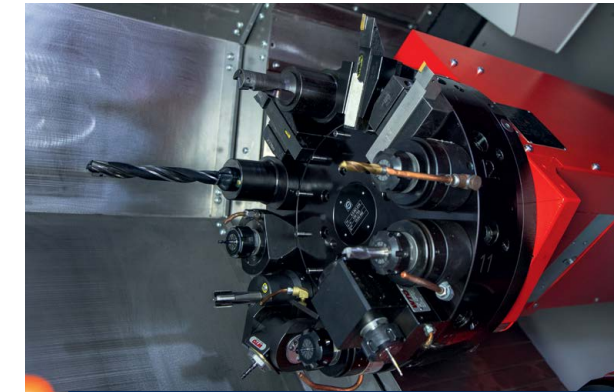

TOOL TURRET / TAILSTOCK VERSION

Axial tool turret for the tailstock version. Quick 12-fold servo turret with very short indexing times for standardized VDI 30 or VDI 40 tools. All stations can include driven tool holders for drilling, milling or thread-cutting operations. The operator can influence the swing speed at any time.

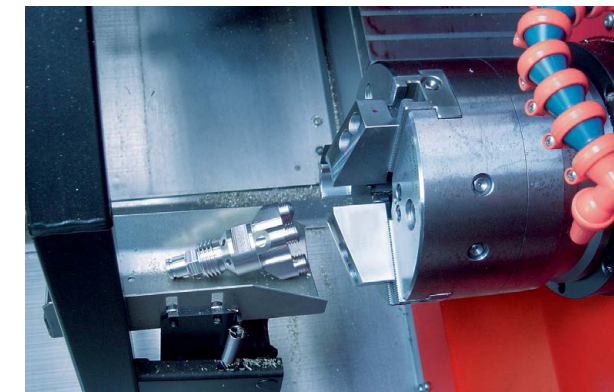

PART PICK-UP DEVICE

Finished parts are transported from the main and counter spindle to the finished parts holder with the part pick-up device. This proven EMCO concept with the pivoting pick-up tray ensures optimum accessibility to the work area, free chip flow and the gentle removal of the finished parts.

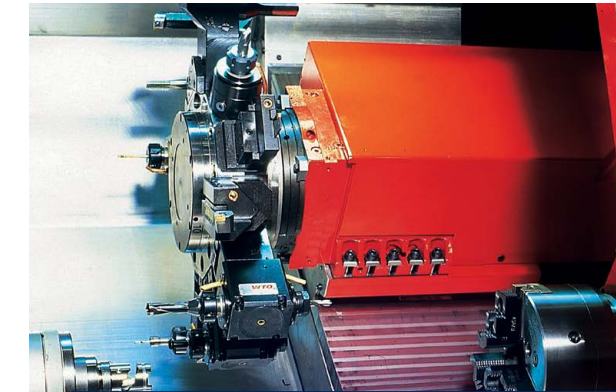

TOOL TURRET / COUNTER SPINDLE VERSION

Radial tool turret for the counter spindle version. Quick 12-fold servo turret with very short indexing times for standardized VDI 30 or VDI 40 tools. Angular holders equipped with ground alignment plates. No additional time consuming alignment necessary. All stations are driven and the indexing speed can be influenced by the operator at any time.

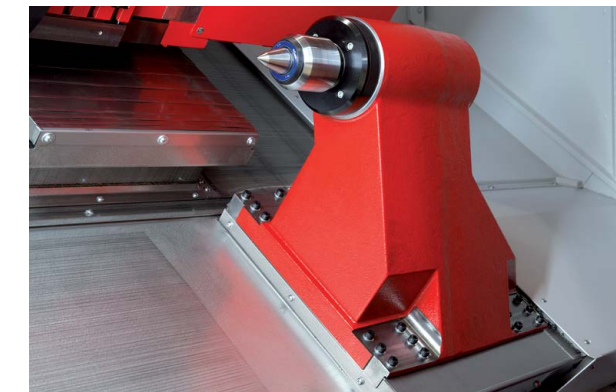

TAILSTOCK

In order to support slim components, the EMCOTURN E65 includes a fully automatic tailstock. It is hydraulically moved over a length of 500 mm. The centre with MT4 cone is directly included in the tailstock body. This ensures compactness and highest stability.

HIGHLIGHTS

- / Powerful driven tools
- / Y-axis for complex milling operations
- / Counter spindle for complete machining
- / Flexible automatic tailstock
- / Top machining precision
- / Very compact machine layout
- / State-of-the-art control technology from Siemens Sinumerik 828D, Fanuc Oi TF or Heidenhain CNC PILOT 640 incl. Shop Turn / Manual Guide i / Smart Turn
- / Made in the Heart of Europe

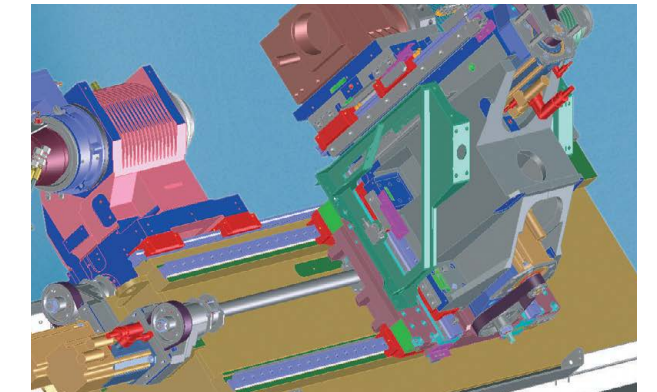

Y-AXIS CARRIAGE

The 90° offset machine base with the broad-based, prestressed guide rails ensures short overhangs and top stability for complete machining.

THE CNC CONTROL UNIT: THE BRAINS OF EACH CNC LATHE

Machine tools are facing ever-increasing requirements. They are supposed to be ever faster, ever more precise and ever more user-friendly! Nowadays, these criteria are met by modern CNC control units. What is new, however, is the wish for networking, something that the state-of-the-art controls included in EMCO's machine tool programme are capable of. Many customers are asking for standardized control units within their production. In order to cater for these needs, the EMCOTURN E65 is available with three control versions.

FANUC Oi TF

The CNC-series Oi TF model is the ideal solution for compact high-end lathes. An attractive price-performance ratio teamed with unmatched dynamics, precision and reliability. This control unit is characterised by easy operation and programmability. Using the FOCAS interface, it can easily be connected to higher-level IT systems, whilst offering maximum performance and functionality. Easy and rapid automation by means of a robot or gantry loader is guaranteed.

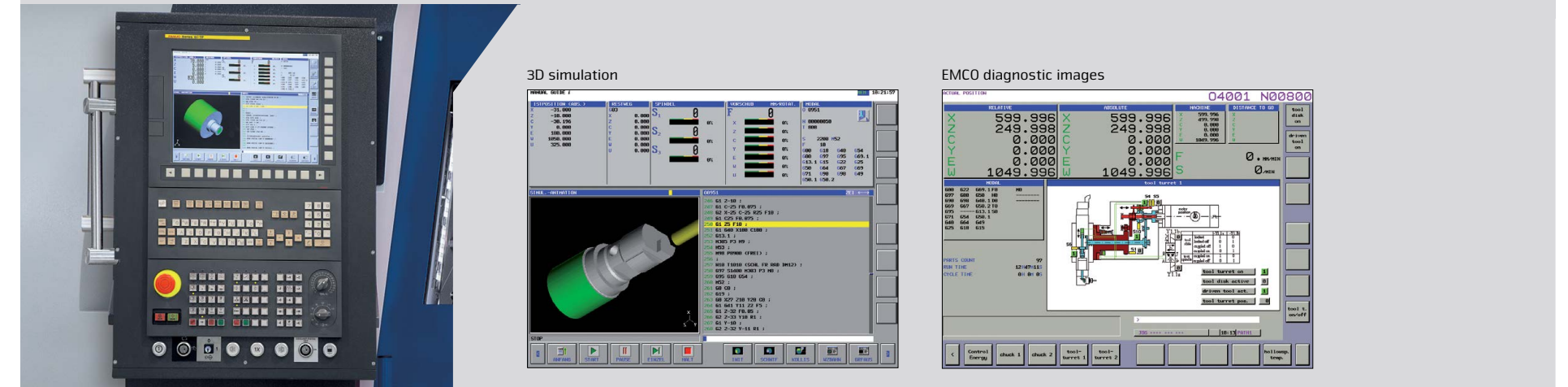

SINUMERIK 828D

High-performance CNC control for maximum precision and processing speed. Thanks to a flexible CNC programming language and unique ShopTurn work stage programming, both large-scale production parts and individual workpieces may be programmed and machined with maximum efficiency. With powerful kinematic transformations and a comprehensive set of technology cycles, the SINUMERIK 828D is also ideal for sophisticated machining with driven tools and counter spindle.

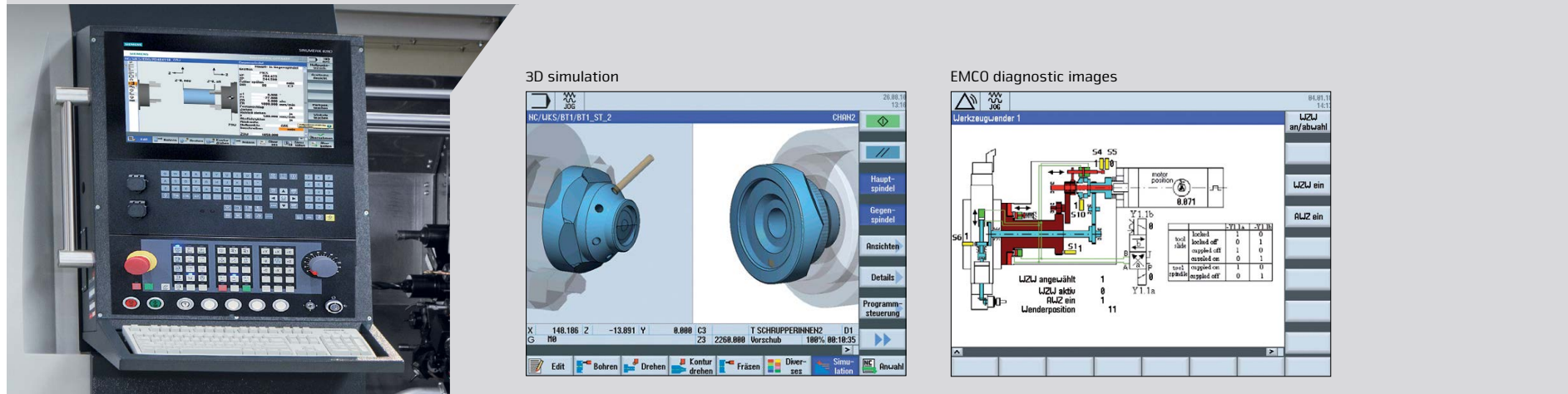

HEIDENHAIN CNC PILOT 640

Thanks to the flexible design and due to its versatile programming possibilities, Heidenhain's CNC PILOT 640 always offers the right support – regardless of whether you manufacture simple or complex workpieces. The CNC PILOT 640 is characterised by easy operation and programming, which is why it requires only little training.

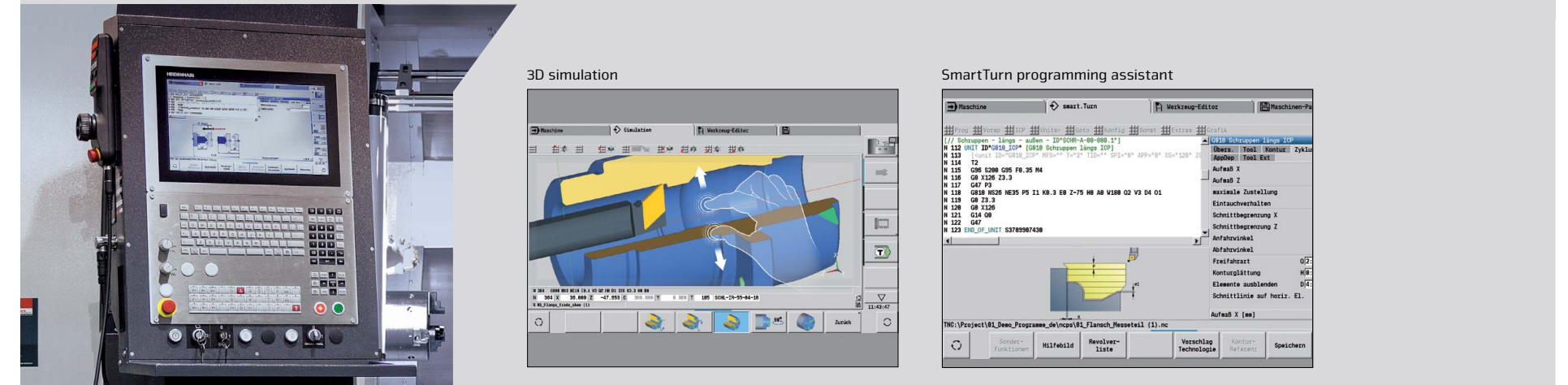

THE EMCO GANTRY LOADER. INDIVIDUAL PROCESS OPTIMIZATION.

- 1 GANTRY LOADER
- 2 PALLET MAGAZINE (20 stations)
- 3 GRIPPER SYSTEM



ADVANTAGES

- / Fully automated loading and unloading of the workpieces
- / Multi-channel Sinumerik control incl. user cycles
- / Seamless interplay between the machine tool and the loading device
- / Varied possibilities of customer-specific adaptation
- / Possibility of integration of measuring station, signing station, cleaning station, etc.
- / Short non-productive times due to a loading hatch

AUTOMATIC RETURN ON INVESTMENT

Workpiece magazine

Blank-specific pallet attachments enable oriented loading of blanks into the machine and increase the parts stock for unmanned production. Changeover times are reduced or eliminated thanks to the perfect adjustment to the customer's parts.



4-station pallet attachment for tees

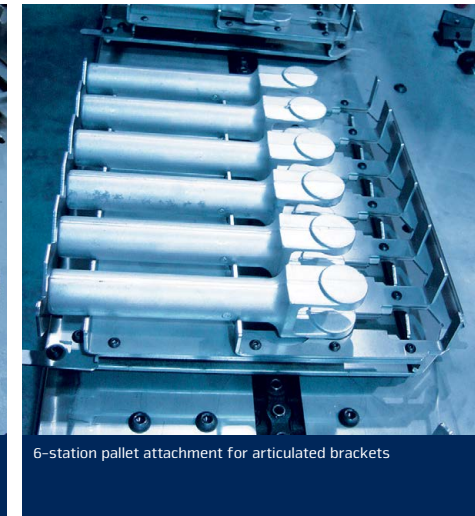

6-station pallet attachment for articulated brackets

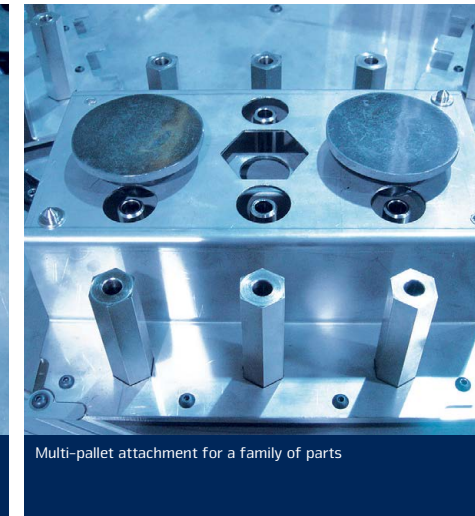

Multi-pallet attachment for a family of parts



4-station pallet attachment for valve caps



20-station pallet magazine with customer-specific pallets

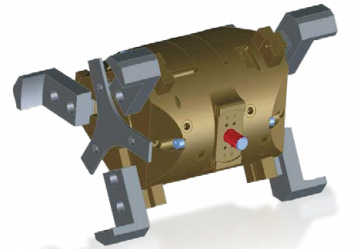

2 x 3-jaw double gripper head

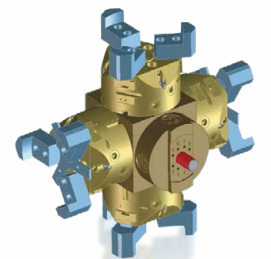

4 x 3-jaw gripper head

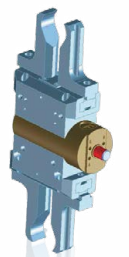

Shaft gripper head

OPTIONS

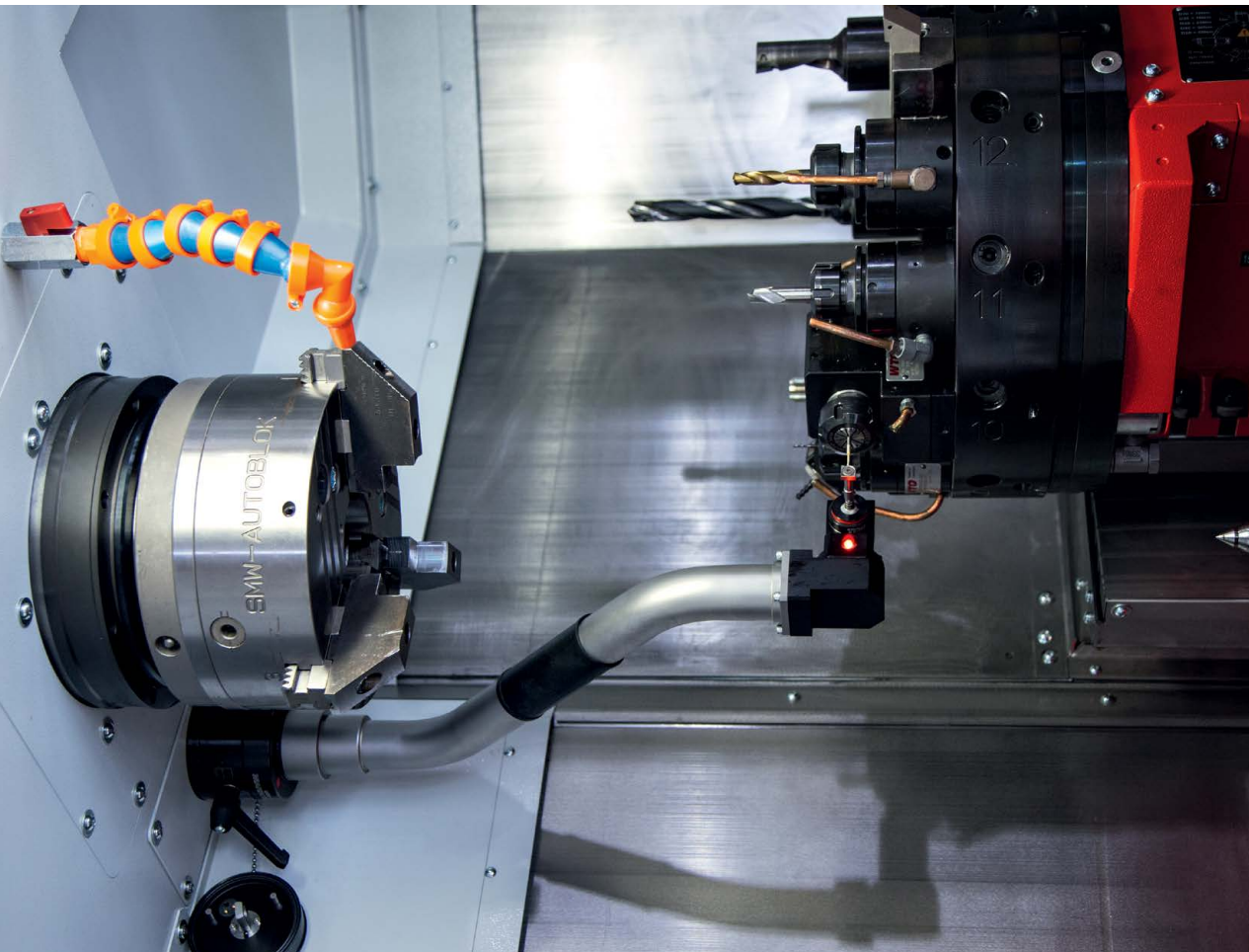

TOOL MEASUREMENT

The optional tool measuring sensor in the work area allows for fast and precise tool measurement within the machine. It is manually mounted below the main spindle. After use, it is removed and placed onto a tray on the left-hand side of the machine casing.

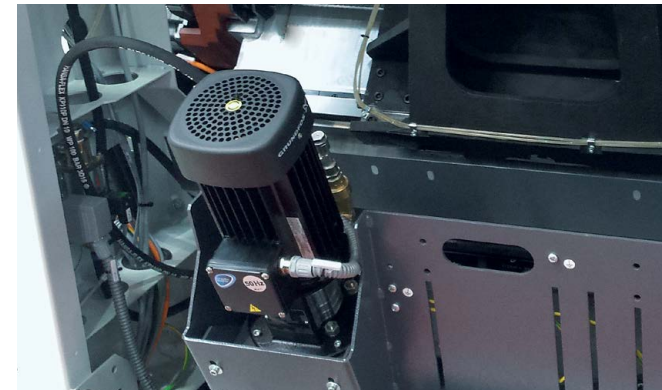

INCREASED COOLANT PRESSURE

A 14 bar coolant pump is available as an option and alternative to the 3.5 bar version. It completes the pumps in the basic machine. For maintenance purposes and to clean the coolant tray, the pumps can easily be swung out so that the coolant tray can be pulled out towards the front.

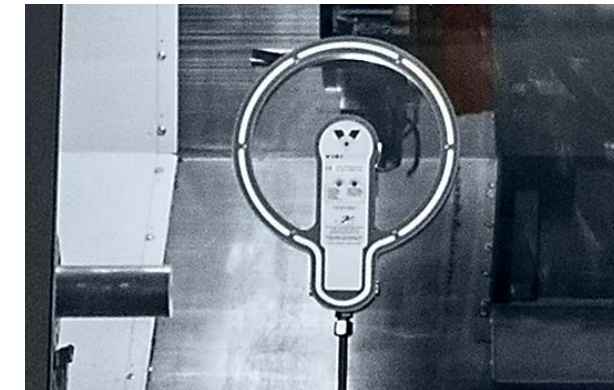

SPIN WINDOW

The optional spin window allows for a perfect view into the work area, also during machining with coolant. Thanks to the spinning pane, the coolant is slung away immediately after the impact. Thus, the pane remains perfectly clear.



MEASURING SENSOR STORAGE

Protected storage area for the measuring sensor and the adjustment gauge.



FINISHED PARTS CONVEYOR

The finished parts catcher places the machined parts onto a collector belt. Since the belt is clocked, the parts – which are often very complex – are kept from falling on top of each other.



BELT FILTER SYSTEM

If required, it is possible to install an optional 600 litres belt filter system with 25 bar high-pressure coolant pumps. It increases both the cooling emulsion volume and the coolant's service life.



EMCO SHORT LOADER

In order to tackle the ever-increasing pressure relating to machine footprints, EMCO has developed the most compact short loader available on the market: EMCO SL 1200.

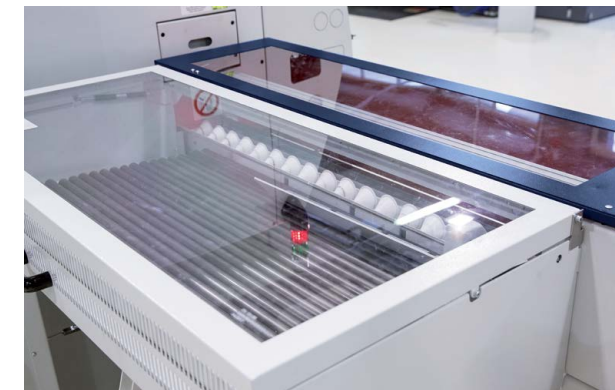

MATERIAL SUPPORT

The material support attached to the back of the SL 1200 features a surface of 560 x 1210 mm and allows stocking a large number of bars. This allows for unmanned production. To ensure compliance with the safety guidelines, the material support is covered by a hood.



OPERATING PANEL

The operating buttons and the diameter adjustment are located on the front side of the SL 1200. If required, the loader can easily be moved 400 mm to the left.

WORK AREA

Work area E65 with counter spindle - VDI 30

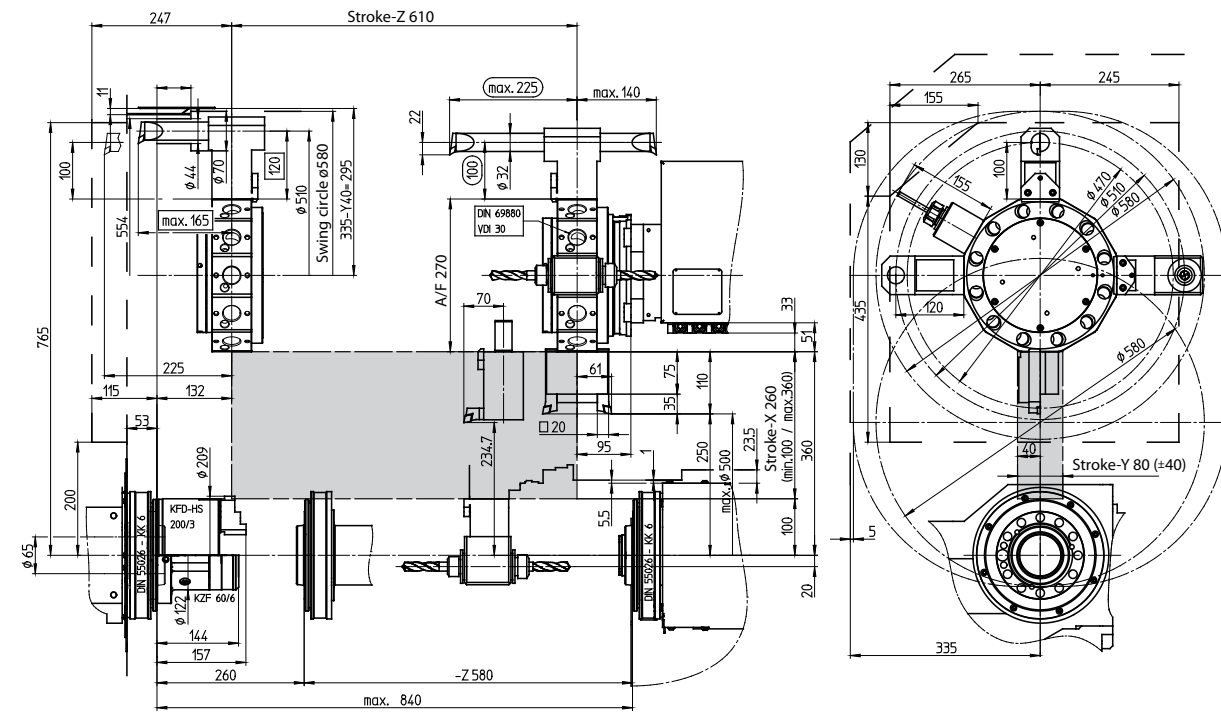

Indications in millimeters

WORK AREA

Work area E65 with tailstock - VDI 40

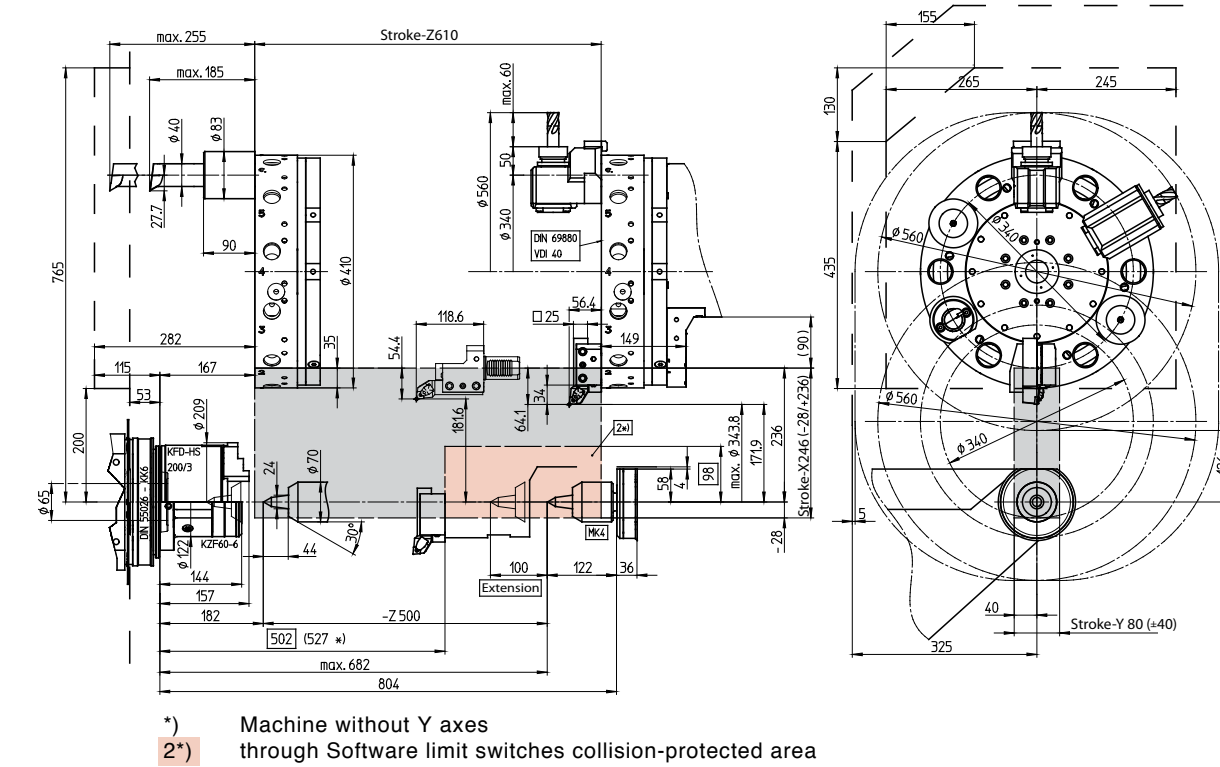

Indications in millimeters

WORK AREA

Work area E65 with counter spindle - VDI 40

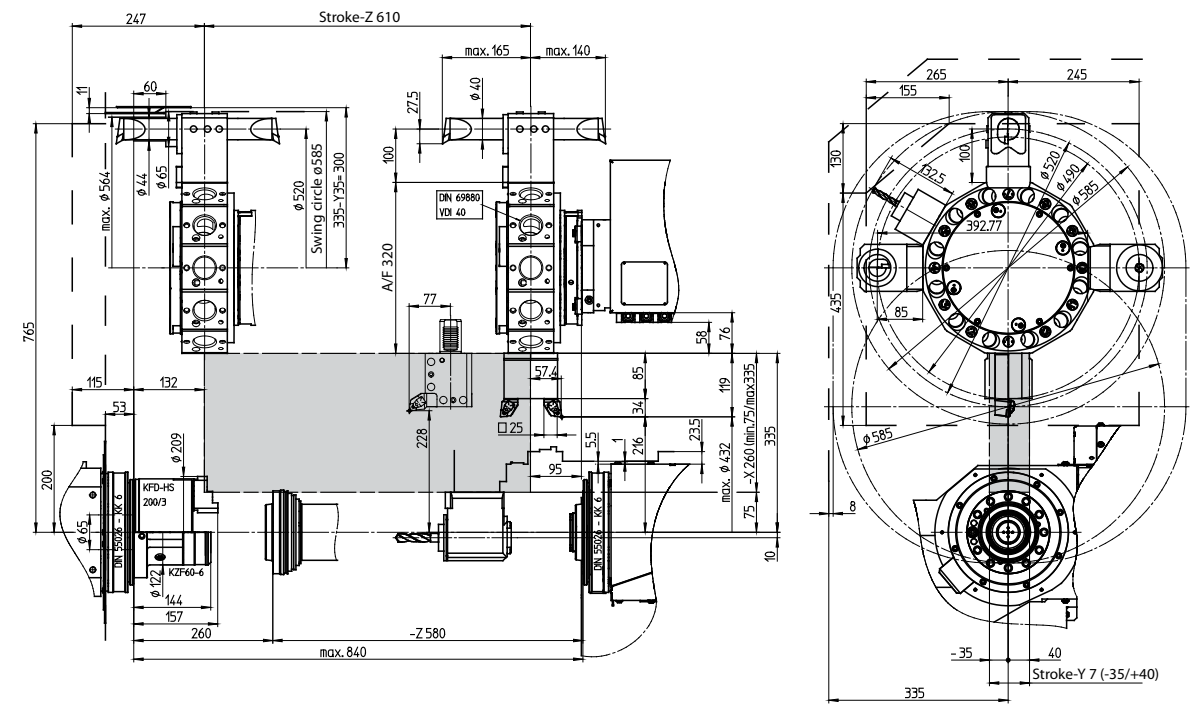

Indications in millimeters

POWER AND TORQUE

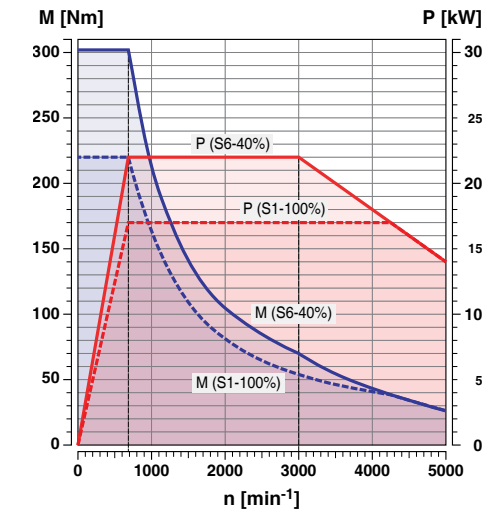

Motor characteristics for main spindle size 65

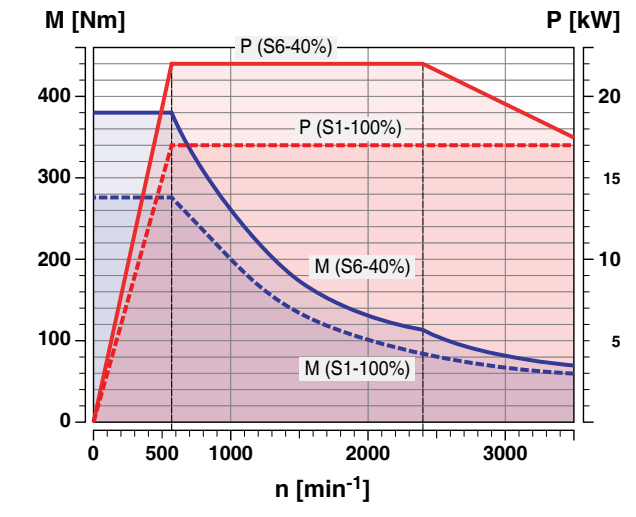

Motor characteristics for main spindle size 95

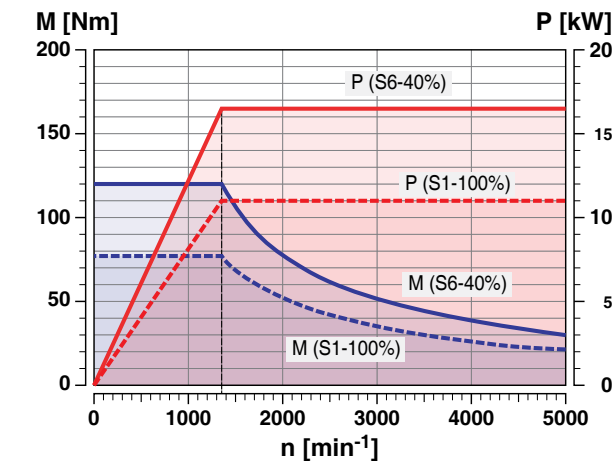

Motor characteristics for counter spindle

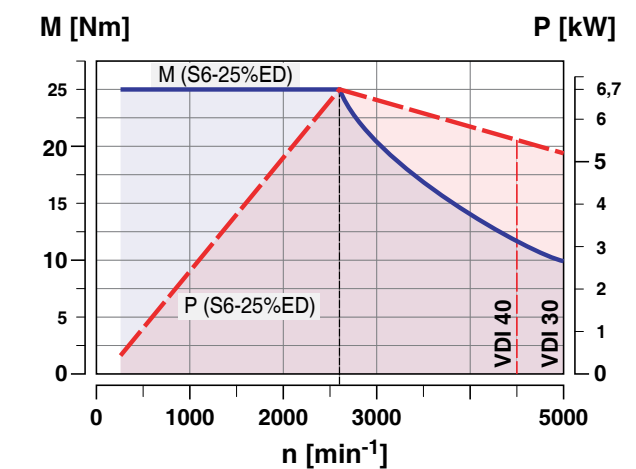

Tool turret motor characteristics for driven tools

Technical Data

Work area

Swing over bed	Ø 610 mm
Swing over slide	Ø 360 mm
Distance between centers on tailstock version	682 mm
Main spindle / counter spindle distance	840 mm
Maximum turning diameter	Ø 500 mm
Maximum part length	520 mm
Maximum bar diameter	Ø 65 (95) mm

Travel

Travel in X / Z	260 / 610 mm
Travel in Y	80 (+/-40) mm

Main spindle

Speed range	0 – 5000 (3500) rpm
Maximum drive power	22 kW
Max. torque on the spindle	305 (380) Nm
Spindle nose DIN 55026	A2-6 (A2-8)
Spindle bearing (inner diameter at front)	105 (160) mm
Spindle bore hole	73 (105) mm

Counter spindle

Speed range	0 – 5000 rpm
Maximum drive performance	16,5 kW
Max. torque on the spindle	130 Nm
Spindle nose DIN 55026	A2-6
Spindle bearing (inside diameter at front)	105 mm
Spindle bore hole	73 mm

Tailstock

Tailstock travel	500 mm
Maximum thrust	8000 N
Maximum travel speed	approx. 20 m/min
Tailstock bore taper	MT4

C-axis

Round axis resolution	0,001°
Rapid motion speed	1000 rpm

Tool turret

Number of tool positions (all driven)	12
VDI shaft (DIN 69880)	30 (40) mm
Tool cross-section for square tools	20 x 20 (25 x 25) mm
Shaft diameter for boring bars	32 mm
Tool change time	0,2 (0,3) sec.

Driven tools DIN 5480

Speed range	0 – 5000 (4500) rpm
Maximum torque	25 Nm
Maximum drive power	6,7 kW

Feed drives

Rapid motion speed X / Y / Z	30 / 15 / 30 m/min
Feed force in X / Y / Z	5000 / 7000 / 7000 N
Feed force in Z2 axis (counter spindle)	8000 N
Positioning scatter Ps VDI 3441 in X / Y / Z	2 / 2 / 2 µm *

* For machines including laser measurement and pitch error compensation

Coolant system

Tank volume (optional)	230 (830) liters
Coolant pressure (optional)	3,5 (14 / 25) bar
Pump power (optional)	0,57 (2,2 / 3) kW

Power consumption

Connected load	39 kVA
Compressed air	6 bar

Dimensions and weight

Height of spindle center above floor	1150 mm
Machine height	2450 mm
Machine footprint L x D	3335 x 2315 mm
Total weight	approx. 6500 kg

EMCO SL 1200

Bar length	250 – 1100 mm
Bar diameter	approx. Ø 8 – 95 mm
Material support	ca. 560 mm
Length	1700 mm
Width	1250 mm
Height (spindle center)	1090 – 1380 mm
Weight	approx. 500 kg

Safety devices CE compliant

beyond standard /

EMCO GmbH / Salzburger Str. 80 / 5400 Hallein-Taxach / Austria / T +43 6245 891-0 / F +43 6245 86965 / info.at@emco-world.com

www.emco-world.com