

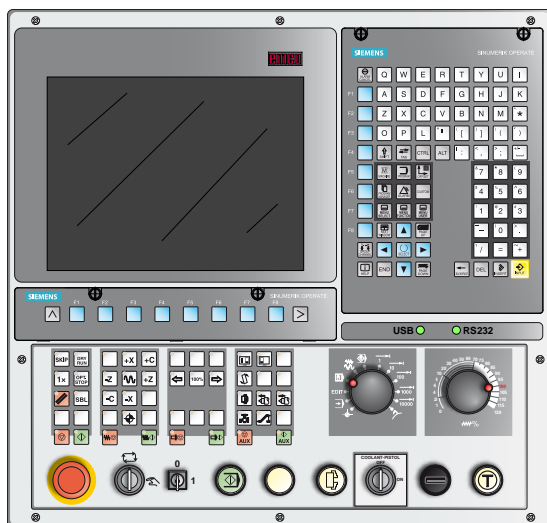

EMCO WinNC for Sinumerik Operate Turn



Software description WinNC for Sinumerik Operate Turn

Ref. no. EN 1849
Edition C 2013-12

These instructions are also available at any time
on request as electronic copy (.pdf).

original instruction manual

from softwareversion 01.04

EMCO GmbH

P.O. Box 131

A-5400 Hallein-Taxach/Austria

Phone +43-(0)62 45-891-0

Fax +43-(0)62 45-869 65

Internet: www.emco-world.com

E-Mail: service@emco.at

**Note:**

This manual can be used as a reference for the available scope of the described software (in the SW version to which the manual refers). All functions described in this document are implemented in the manner described here.

However, the scope of this manual doesn't necessarily include the entire functionality of the control software. Rather, emphasis is placed on presenting the important functions simply and clearly in order to achieve the greatest possible learning success.

Depending on the machine you are operating with this software (or have selected for the programming station), not all functions are available (example: the Concept machines TURN/MILL 55 has no position-controlled main spindle, therefore it's not possible to program spindle positions).

Preface

The EMCO WinNC for Sinumerik Operate software is a component of the EMCO training concept.

EMCO WinNC for Sinumerik Operate makes it easy to operate CNC lathes/milling machines. Neither is prior knowledge of ISO programming needed.

An interactive contour programming routine means you can define workpiece contours with linear and circular contour elements.

A cycle is programmed interactively, with graphics support. A large number of processing cycles, which can be combined freely with each other to form a single program, is available to the user.

Individual cycles or the NC programs produced can be simulated graphically on screen.

Some of the functionality of the EMCO WinNC for Sinumerik Operate control software is beyond the scope of these instructions. Emphasis is placed instead on representing the most important functions simply and clearly, in order to achieve the greatest possible learning success.

If you have queries about or suggestions for improving these operating instructions, please make direct contact with [name needed!]

EMCO GmbH
Dep. Technical Documentation
A-5400 HALLEIN, Austria

The EMCO logo consists of the word "emco" in a bold, red, sans-serif font. The letters are lowercase and have a slightly irregular, blocky appearance.

EC compliance



The CE symbol, together with the EC compliance declaration, certifies that the machine and instructions comply with the directives under which the products are covered.

All rights reserved. Copying only with permission from EMCO GmbH
© EMCO GmbH, Hallein

Table of contents

Preface 3
 Table of contents 4

A: Principles

EMCO lathe reference points A1
 M = Machine zero point A1
 R = Reference point A1
 N = Tool housing reference point A1
 W = Workpiece zero point A1
 Lathe reference system A2
 Absolute and incremental workpiece positions A3
 Zero point offset A4

B: Key description

WinNC for Sinumerik Operate control keyboard B1
 WinNC for Sinumerik Operate control keyboard B3
 Variant with Easy2control and MOC-Touch B3
 Address and number pad B4
 Button functions B5
 Shortcuts B7
 Screen layout B8
 PC keyboard B9
 Overview button assignment control keyboard B10
 Overview Button Assignment Machine Operating Elements ..
 B11
 Machine control panel B13
 Key description B13
 Skip (block mask) B13
 Dryrun (test-run feed) B13
 Individual piece mode B14
 Optional stop B14
 Reset key (Reset) B14
 Single block B14
 NC Stop B14
 NC Start B14
 Arrow keys B15
 Reference point B15
 Rapid Traverse B15
 Feed Stop B15
 Feed Start B15
 Spindle speed correction B15
 Spindle Stop B15
 Spindle Start B15
 Automatic machine doors B15
 Chip conveyor (Option) B16
 Clamping device B16
 Manual tool change B16
 Tailstock forwards, tailstock backwards B16
 Coolant B16
 Auxiliary OFF B16
 Auxiliary ON B16
 Types of operation B17
 Override switch (feed rate override) B19
 EMERGENCY STOP B19
 Key Switch Special Operations Mode B19
 Multifunction switch for operating modes B20
 Key switch B23
 Additional NC start button B23
 USB connection (USB 2.0) B23
 Enable button B23

C: Operation

Feed F [mm/min] C1
 Speed fundamentals C2
 Spindle speed S [rev/min] C3
 Machine operating area C4
 Types of operation C4
 Approach reference point C6
 Move slides manually C7
 Move slides in step-movement C7
 Screen division T, S, M C9
 Move Axes C10
 Approach target position C11
 Parameters operating area C12
 Tool data C12
 Zero point offset C12
 Show overview of zero point offsets C13
 Measure workpiece zero point C13
 Set edge C14
 R-parameters (calculation parameters) C15
 Setting data C16
 Program management C17
 Where programs are saved C17
 Create program C18
 Delete program C19
 Copy program C19
 Open / close program C20
 Select / deselect program C20
 Print program C21
 Program influence C22
 Block search run C26
 Correct program C27
 Show G-functions C28
 Show all G-functions C30
 Show basic blocks C31
 Show running time and workpieces C32
 Show program levels C34
 MCS / WCS switch C35
 Editing program blocks C36
 Quit editing C36
 Search program block C36
 Search and replace program text C37
 Move program block C38
 Change cycle C38
 Copy program block C39
 Delete program block C39
 Renummer program block C39
 Define settings for program blocks C40
 Calculation operators in input fields C40
 Backup fitting data C42
 Graphical simulation C44
 Screen layout graphical simulation C45
 softkey functions C46
 Simulating workpiece processing C46
 Select workpiece view C47
 3D view configuration C47
 Zoom graphics C48
 Shift graphics C49
 Block-by-block simulation C50
 Simulation alarm C51
 Quit graphical simulation C51
 Diagnostics operating area C52
 Show alarm list C52
 Show messages C52

Version data	C52
Commissioning operating area.....	C53
Close Sinumerik Operate.....	C53
Restart Sinumerik Operate.....	C53

D: ShopTurn programming

Overviews	D1
M-Commands	D1
Create ShopTurn program	D2
Program header	D3
End of program.....	D5
Raw part definition	D6
Cycle overview	D7
Working with cycles.....	D10
Geometry and technology data input	D11
Default values for cycle parameters	D12
Ignore plausibility check for saving.....	D13
Set length tool wear	D13
Set system of measurement	D14
Drilling	D15
Drilling centrally.....	D16
Thread drilling centrally.....	D18
Centering.....	D22
Drilling	D24
Abrading.....	D26
Deep hole drilling	D28
Thread tapping	D30
Positions and position template.....	D34
Arbitrary positions	D36
Position template line, grid or frame	D38
Position template circle.....	D40
Turn	D43
Machining 1	D44
Machining 2.....	D46
Machining 3.....	D48
Grooving 1.....	D52
Grooving 2.....	D54
Grooving 3.....	D56
Free grooving	D60
Free groove, DIN thread	D62
Free groove thread.....	D64
Thread longitudinally.....	D66
Tapered thread.....	D72
Plane thread.....	D76
Grooving.....	D80
Contour turning	D83
Create new contour.....	D84
Change contour.....	D91
Machining.....	D92
Grooving.....	D96
Milling.....	D99
Rectangular pocket	D100
Circular pocket	D104
Elbow spigot	D108
Circular spigot	D110
Multiple edge.....	D112
Longitudinal slot	D114
Circumferential slot	D118
Open slot	D122
Thread milling.....	D128
Engraving	D132
Contour milling	D137
Create new contour.....	D138
Change contour.....	D145
Path milling.....	D146

Pre-drill contour pocket.....	D149
Centering.....	D150
Preliminary drilling.....	D152
Mill pocket	D154
Mill spigot	D158
Various	D161
Settings	D162
Transformations	D164
Call up sub-routine.....	D172
Repeat program blocks.....	D173
Simulation	D177
Straight line or circular machining.....	D179
Straight line or circular machining	D180
Program straight line	D181
Program circle with known center point.....	D182
Program circle with known radius.....	D183
Polar coordinates	D184
Straight line polar	D185
Circle polar.....	D186
Tool.....	D188

E: G-code programming

Overviews	E1
M-Commands	E1
Overview G-commands	E2
Command abbreviations overview	E3
Calculation operators for NC program.....	E6
System variables.....	E8
G-commands	E11
G0, G1 straight line interpolation (cartesian).....	E11
G2, G3, circle interpolation	E12
G4 Dwell time.....	E15
G9, G60, G601, G602, Precision stop.....	E16
G64 Path control mode	E17
G17, G18, G19 Level selection.....	E18
G25, G26 Spindle speed limitation	E19
G33 Thread cutting	E20
G331/G332 Thread tapping without compensation chuck.....	E20
G63 Thread tapping without synchronisation.....	E21
Tool radius correction G40-G42	E22
Tool radius correction G40-G42.....	E24
Zero point offset G53-G57, G500-G599, SUPA.....	E25
Inch-cased measurements G70, Metric measurements G71..	E25
Coordinates, Zero points.....	E26
G90 absolute measurement input.....	E26
G91 Chain measurement input	E26
Feed programming G94, G95.....	E27
Constant cutting speed G96, G97, LIMS.....	E28
Polar coordinates G110-G112.....	E31
Gentle approach and withdrawal G140 - G341, DISR, DISCL	E32
Collision monitoring NORM, CONT	E35
Cycle overview.....	E37
Working with cycles.....	E38
Invoking cycles.....	E40
Default values for cycle parameters	E41
Ignore plausibility check for saving.....	E42
Set length tool wear	E42
Set system of measurement	E43
Drilling	E45
Centering (CYCLE81)	E46
Drilling (CYCLE82).....	E48
Abrading (CYCLE85).....	E50
Drilling deep holes (CYCLE83)	E52
Turn out (CYCLE86).....	E56

Tapping (Cycle84, 840)..... E58
 Thread mill drilling (Cycle78)..... E64
 Positions and position template..... E68
 Arbitrary positions (CYCLE802)..... E70
 Position template line (HOLES1), grid or frame (CYCLE801) . E71
 Position template circle (HOLES2) E72
Turn E75
 Machining 1 (CYCLE951) E76
 Machine 2 (CYCLE951)..... E78
 Machine 3 (CYCLE951)..... E80
 Grooving 1 (CYCLE930) E84
 Grooving 2 (CYCLE30) E86
 Grooving 3 (CYCLE930) E88
 Free groove (CYCLE940)..... E92
 Free groove GDIN (CYCLE940)..... E94
 Free groove thread (CYCLE940) E96
 Longitudinal thread (CYCLE99) E98
 Tapered thread (CYCLE99)..... E104
 Transverse thread (CYCLE99)..... E108
 Chain thread (CYCLE99) E112
 Cutoff (CYCLE92)..... E116
Contour turning E119
 Create new contour..... E120
 Contour element straight line Z..... E121
 Contour element straight line X E122
 Contour element straight line ZX E123
 Contour element circle E124
 Change contour..... E127
 Machine (CYCLE952)..... E128
 Groove (CYCLE952) E132
 Rotary groove (CYCLE952) E134
Milling E137
 Elbow pocket (POCKET3)..... E138
 Circular pocket (POCKET4) E142
 Elbow spigot (CYCLE76)..... E146
 Circular spigot (CYCLE77)..... E148
 Multiple edge (CYCLE79)..... E150
 Longitudinal slot (SLOT1)..... E152
 Circular slot (SLOT2)..... E156
 Open slot (CYCLE899)..... E160
 Long hole (LONGHOLE)..... E164
 Thread milling (CYCLE70) E166
 Engraving (CYCLE60)..... E170
Contour milling E173
 Create new contour..... E174
 Contour element straight line X E175
 Contour element straight line Y E176
 Contour element straight line XY E177
 Contour element circle E178
 Change contour..... E181
 Contour call-up (CYCLE62) E182
 Path milling (CYCLE72)..... E184
 Pre-drill contour pocket (CYCLE64) E187
 Centering (CYCLE64) E188
 Pre-drilling(CYCLE64)..... E190
 Mill pocket (CYCLE63) E192
 Mill spigot (CYCLE63) E196
Various E199
 Unmachined part data..... E201
Raw part definition E202
Frames E203
 Zero point offset TRANS, ATRANS E204
 Rotate coordinate system ROT, AROT E205
 Scale SCALE, ASCALE E206
 Mirror coordinate system MIRROR, AMIRROR E207
Sub-routines..... E209
 Modal sub-program MCALL E211

Call up sub-routine..... E212
 Program jumps E213
Bar Loading Interface E216
C-axis E218
 Set spindles SPOS, SPOSA..... E219
TRANSMIT - Cycle E222
 Programming functions without cycle support..... E223
Cylinder interpolation TRACYL E225
 Example - Contour milling..... E225
 Example - Cam milling E226
 CFTCP, CFC, CFIN feed optimization E227

F: Tool programming

Tool management F1
 Sorting function F2
 Tool list F3
 Create new tool F5
 Create/Delete tool blades F6
 Delete tool F6
 Load tool F7
 Unload the tool F7
 3D tool F8
 Color select F9
 Tool wear F10
 OEM tool F11
 Magazine..... F12
 Position magazine..... F13
 Tool correction F15
 Measuring tool manually..... F18
 Measure the tool with the optical default setting device at the machine..... F22

G: Program sequence

Preconditions G1
 NC start G2
 NC reset G2
 NC Stop G2
 Program start, program stop..... G2
 Repositioning G3

H: Alarms and Messages

Machine Alarms 6000 - 7999..... H1
 Inputunit alarms 1700 - 1899 H17
 Axis Controller Alarms H19
 8000 - 9000, 22000 - 23000, 200000 - 300000 H19
 Axis Controller Messages..... H26
 Control alarms 2000 - 5999 H27

I: Control alarms Sinumerik Operate

Control alarms 10000 - 66000	I1
------------------------------------	----

W: Accessory Functions

Activating accessory functions	W1
Robotic Interface	W1
Automatic doors	W1
Win3D View	W1
Tool modelling with the 3D-Tool Generator	W2
DNC interface	W6

X: EMConfig

General	X1
How to start EMConfig	X2
How to activate accessories	X3
High Speed Cutting	X3
Easy2control on screen operation	X4
Easy2control settings	X5
Machine room camera	X5
Input devices	X6
How to save changes	X6
How to create machine data floppy disk or machine data USB flash drive	X6

Y: External Input Devices

Easy2control On Screen operation	Y1
Scope of supply	Y1
Operating areas	Y2
Machine room camera	Y5
Installing the camera	Y5
Operating the camera	Y6

Z: Software Installation Windows

System prerequisites	Z1
Software installation	Z1
Variants of WinNC	Z1
Starting WinNC	Z3
Terminating WinNC	Z3
Checks by EmLaunch	Z4
Licence input	Z6
Licence manager	Z6

Blank page

A: Principles

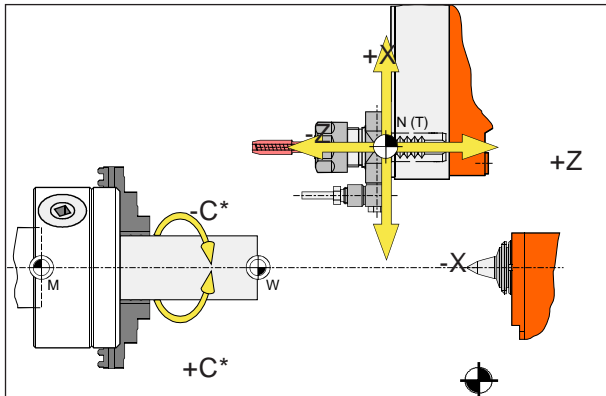

Points on the machine

Instructions:

The actual reference points may have been defined at other positions depending on the machine type. In any case, the information in operation manual of the respective machine applies!



EMCO lathe reference points

M = Machine zero point

An unchangeable reference point defined by the manufacturer of the machine. The entire machine is measured from this point. At the same time, "M" is the origin of the coordinate system.



R = Reference point

A position in the machine's work area defined exactly by the limit switch. Moving the slots to "R" notifies the slot position to the control system. Required after any power cut.



N = Tool housing reference point

Start point for tool measurement. "N" is at an appropriate point of the tool holder system and is defined by the manufacturer of the machine.



W = Workpiece zero point

Start point for the dimensional details in the parts program. Freely definable by the programmer and often movable at random within a parts program.

Lathe reference system

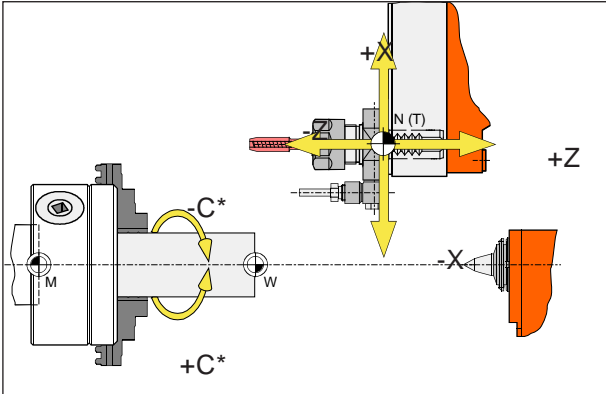

Absolute coordinates are related to a fixed position, incremental coordinates to the tool position.
 * only for power tools

With a reference system, you define positions in a plane or in space unambiguously. Positional information always relates to a given point and is described by means of coordinates.

In the right-angled system (Cartesian system), three directions are defined as X, Y and Z axes. The axes are perpendicular respectively to one another and intersect in one point, the zero point. One coordinate gives the distance to the zero point in one of these directions. This is how you describe a position in a plane by means of two coordinates and in space by means of three coordinates.

The X-coordinate is in the direction of the transverse slot and the Z-coordinate in the direction of the longitudinal slot.

Coordinate details in the minus direction describe movements of the tool system towards the workpiece and details in the plus direction away from the workpiece.

Coordinates that relate to the zero point are described as **absolute coordinates**. Relative coordinates are related to any other random position (reference point) in the coordinates system. Relative coordinate values are also described as **incremental coordinate** values.

WinNC recognizes movements in straight lines or in circles between programmed points. You can program a workpiece process by entering coordinates and linear or circular movements sequentially.

Angular information for the C-axis is related to the "C-axis zero point".

Instructions:
 The actual reference points may have been defined at other positions, depending on the machine type. In any case, the information in the operation manual for the relevant machine applies!

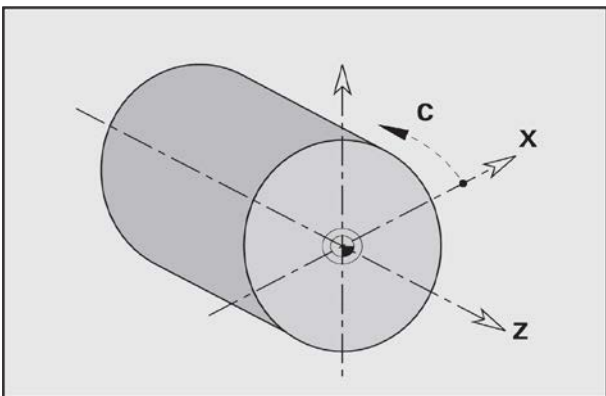

Absolute and incremental workpiece positions

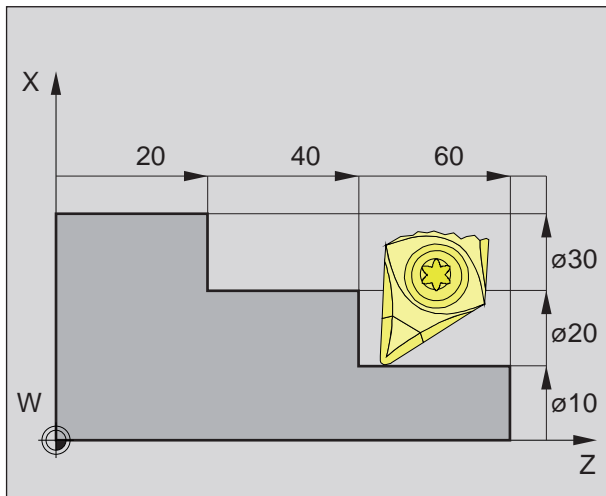

Absolute workpiece positions

If coordinates for a position are related to the workpiece zero point, they are described as absolute coordinates.

Each position of a workpiece is defined unambiguously by absolute coordinates (picture top left).

The origin of the coordinate system is in the machine zero point "M" or, after a programmed zero point shift, in the workpiece zero point "W".

All target points are described starting from the origin of the coordinate system, by stating the relevant X and Z distances.

X distances are given as diameters (as dimensioned on the drawing).

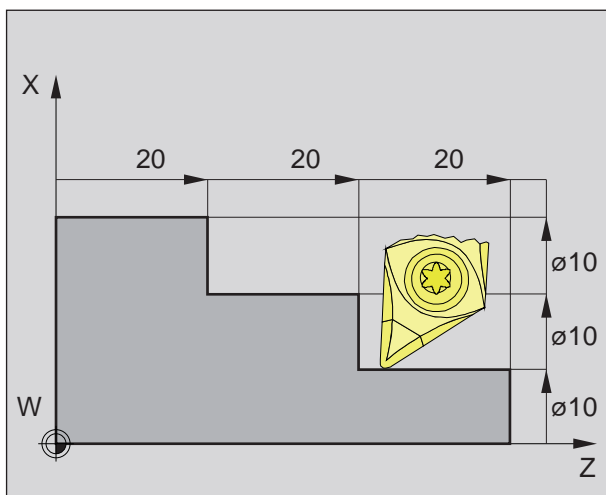

Incremental workpiece positions

Incremental coordinates refer to the last programmed position of the tool, which serves as the relative (conceptual) zero point. Incremental coordinates describe the actual path travelled by the tool. Consequently, it is also described as *****chain measurement*****.

Each position of a workpiece is defined unambiguously by incremental coordinates (picture left).

The origin of the coordinate system is in the tool housing reference point "N" or, after a tool call-up, in the knife point.

Incremental value programming describes the actual paths traveled by the tool (from point to point). X is entered as a radius measurement.

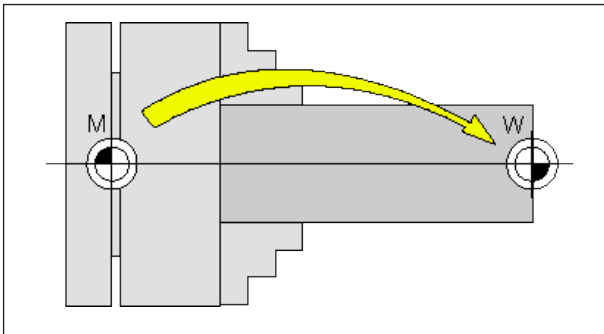

Zero point shift of machine zero point M to tool zero point W

Zero point offset

The machine null point "M" is on the rotating axis and on the face of the spindle flange in EMCO rotating machines. This position is unsuitable as a start point for programming. Using the so-called zero point offset, the coordinate system can be shifted to a suitable point in the machine working area.

A distinction is made between the following zero point offsets:

- Machine coordinate systems (MCS) with the machine zero point M
- Base Zero Point System (BZS)
- Configurable Zero Point System (CZS)
- Workpiece coordinate system (WCS) with workpiece zero point W.

Machine coordinate system (MCS)

After approaching the reference point the NC position displays of the axis coordinates are relative to the machine zero point (M) of the machine coordinate system (MCS).

Workpiece change points are defined in the machine coordinate system.

Base zero point (BZS).

If a base shift is performed in the machine coordinates system (MCS), a base zero point offset is the result (BZS). With this, for example, a palette zero point can be defined.

Configurable zero point system (CZS)

Configurable zero point offset

If a configurable zero point system (G54-G599) is performed from the base zero point system (BZS), a configurable zero point system (CZS) is the result.

Programmable coordinate transformation (Frames)

Programmable coordinate transformations (frames) shift the originally selected workpiece coordinate system to another position, to rotate, scale or mirror it.

Workpiece coordinate system (WCS)

The program for executing the workpiece is relative to the workpiece zero point (W) of the workpiece coordinate system (WCS).

B: Key description

WinNC for Sinumerik Operate control keyboard

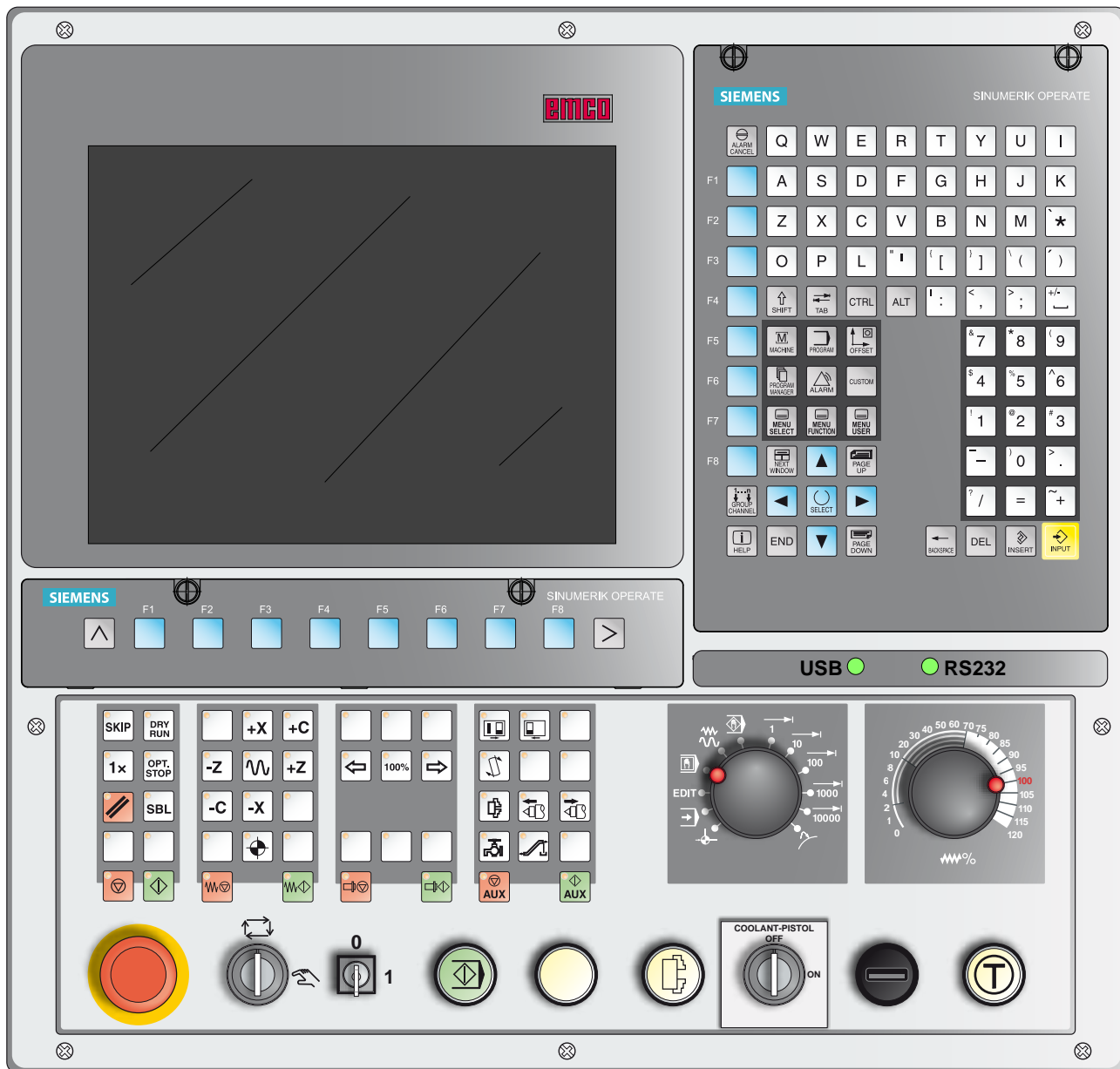

Instructions:
 Depending on the machine you are operating with Sinumerik Operate, not all functions and machine buttons may be available.

WinNC for Sinumerik Operate control keyboard Variant with Easy2control and MOC-Touch

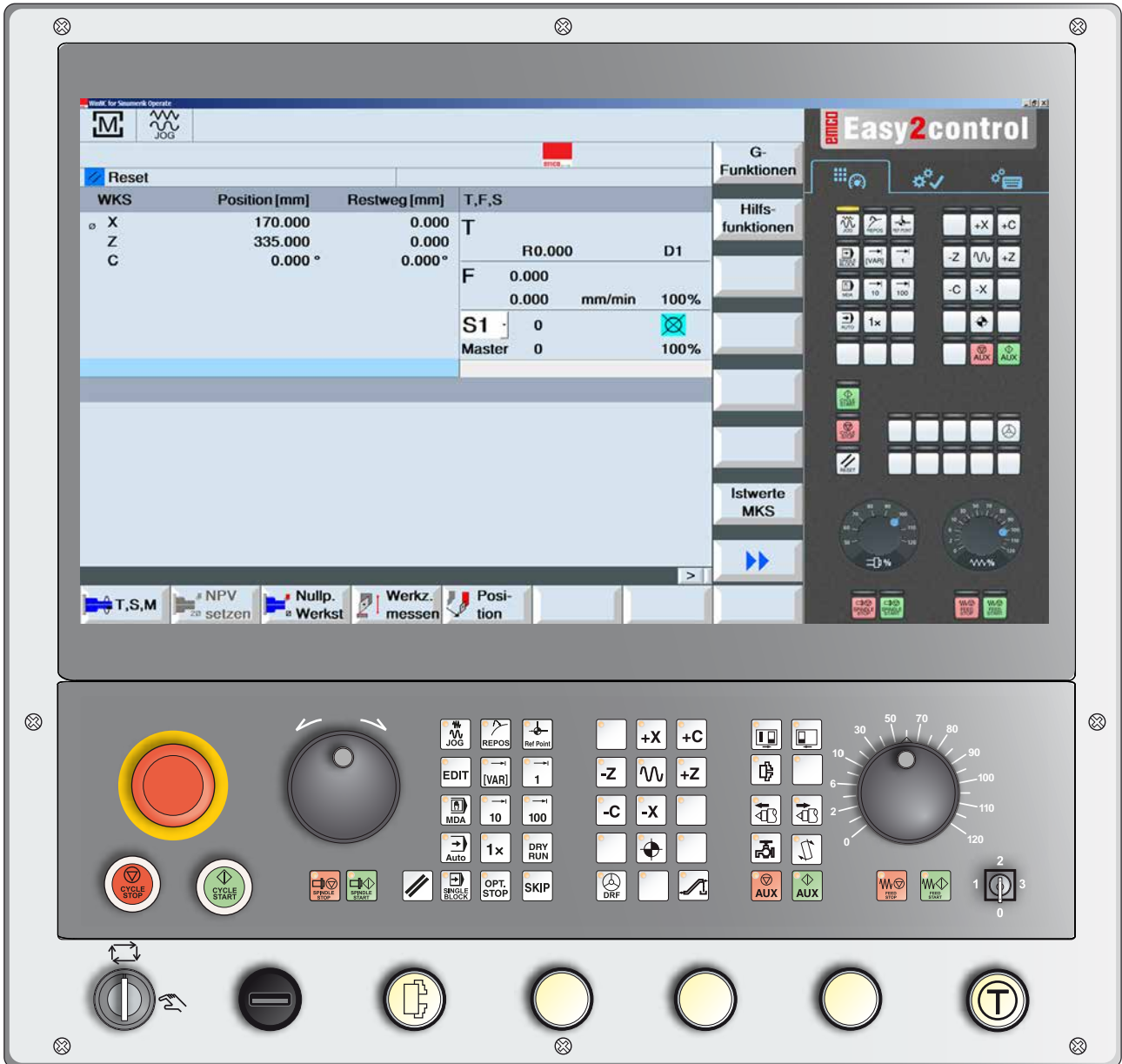

Instructions:
 Depending on the machine you are operating with Sinumerik Operate, not all functions and machine buttons may be available.

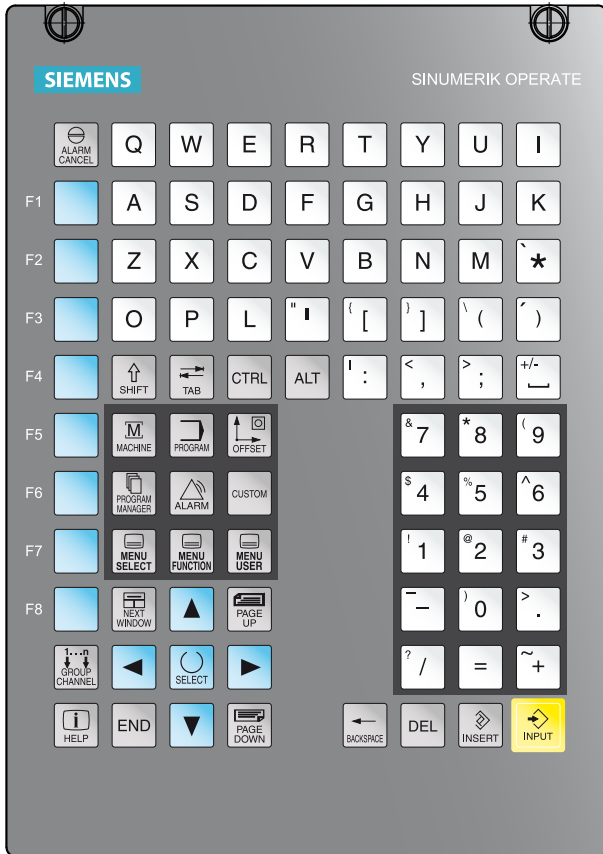



Address and number pad

Address and number pad

The Shift key switches to the second key function (shown in the top left corner of the button).

Example:

- 
Point
- 
Advances to the extended horizontal softkey bar

Button functions



Direct jump to the machine operating area.



Direct jump to the parameter operating area.



Direct jump to the program operating area.



Direct jump to the program manager operating area.



Direct jump to the diagnosis operating area.



Back to the higher-level menu.



Extension of the horizontal softkey bar in the same menu.



Show basic menu (operating area selection).
Jump to the previous operating area when pressed again.



no function



no function



Acknowledge alarm
Pressing this button deletes alarms and reports that are marked with this symbol.



Call context-sensitive help.



Advance screen to next window.
Button input only works on the selected window.



Channel
Select or advance control channel (no function)



Cursor right
Navigates the cursor one symbol to the right.
Edit operational mode:
Open directory or program (e.g. cycle).



Cursor left

Navigates the cursor one symbol to the left.
 Edit operational mode:
 Close directory or program.



Cursor down/up



Scroll backwards/forwards



Space



Delete (Backspace)

- Editing field: Delete a marked character to the left of a cursor.
- Navigation: Delete all marked characters to the left of the cursor.



Delete (DEL)

- Editing field: Deletes the first character to the right of the cursor.
- Navigation: Deletes all characters.



Selection button/Toggle button

- Select button for specified values in input fields and selection lists that are identified by this symbol
- Activating/Deactivating a selection field
- Selects a program block or a program in the program editor and in the program manager.



Edit button/Undo

- Jump to edit mode from the input fields. Pressing the button again will leave the input field unchanged.
- Opens a selection field and shows the options.
- Undo function, as long as the data in the fields has not been applied or the enter button was not pressed.



Calculation function in the input fields



Jump to line end (list end)



























Enter button

- Apply an edited value
- Open/close directory
- Open file



Shift button

Shortcuts

		Copy	
		Cut	
		Paste	
		Repeat input	
		Undo	
		Select all	
		Go to program start	
		Go to program end	
		Mark to end of block	
		Mark to start of line	
		Jump to start of line	
			Close WinNC for Sinumerik Operate.

Screen layout

1 Active operating area and operating mode

2 Alarm and notification lines

3 Program name

4 Channel status and program influence

5 Channel operating report

6 Position display of the axes in the current values window

7 Display for

- active tool T
- instantaneous feed F/ programmed ...feed F
- active spindle with instantaneous speed (S) /programmed master spindle speed
- Spindle utilization in per cent

8 Work window with program display

9 Display of active G-functions, all G-functions, help functions as well as input window for various functions (e.g.: Basic blocks, program influence).

10 Info line for additional user instructions

11 Horizontal and vertical softkey bars

12 Display of basic blocks

13 Time counter for displaying program run time and the number of finished workpieces

14 Display for program levels

For detailed descriptions see chapter "C Operation"













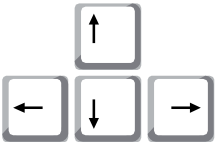
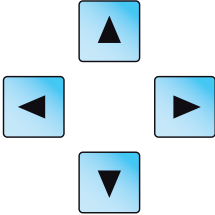



PC keyboard



















To activate patterned key functions, the CTRL or ALT keys must be pressed at the same time.

**Instructions:**
The machine functions in the numerical keypad are only active if NUM Lock is not active.

Overview button assignment control keyboard

PC button	Control system button	Function
		Delete input
		Conclude input and continue dialog.
		Move mark
		Upper/lower case
		Selection button / Toggle button
		Single block (SBL)
		Reset key (Reset)
		Dryrun (test-run feed)
		Optional stop
		Skip (block mask)
 		Call context-sensitive help

Overview Button Assignment Machine Operating Elements

PC button	Control elements	Function
Alt U		Clamping device open / closed
Alt I		Internal/External Clamping (Option Concept Turn 55)
Alt O		Coolant / Purge on / off
Alt P		Door open / closed
Alt H		Tailstock forwards
Alt J		Tailstock backwards
Alt K		Swivel tool holder
Alt X		Feed Stop
Alt C		Feed Start
Alt V		Spindle Stop
Alt B		Spindle Start
Alt N		Switch auxiliary drives on AUX OFF
Alt M		Switch auxiliary drive off AUX ON
Enter		NC Start
,		NC Stop
5		Approach reference point

Instructions: 

Selecting the machine buttons via the PC keyboard:

- 1.) Hold "Alt" button down.
- 2.) Press and then release machine button.
- 3.) Release "Alt" button.

PC button	Control elements	Function
		Spindle speed correction
 The image shows two vertically stacked rectangular buttons. The top button is smaller and contains a minus sign (-). The bottom button is larger and contains a plus sign (+).		Override (feed rate override)

Machine control panel

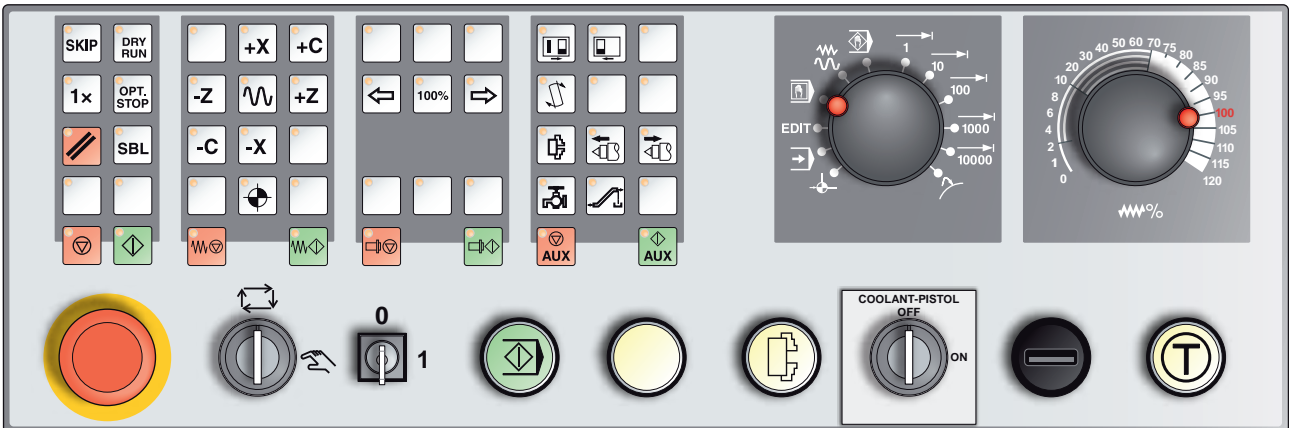

Depending on machine configuration, the control panel can differ slightly from what is shown here.

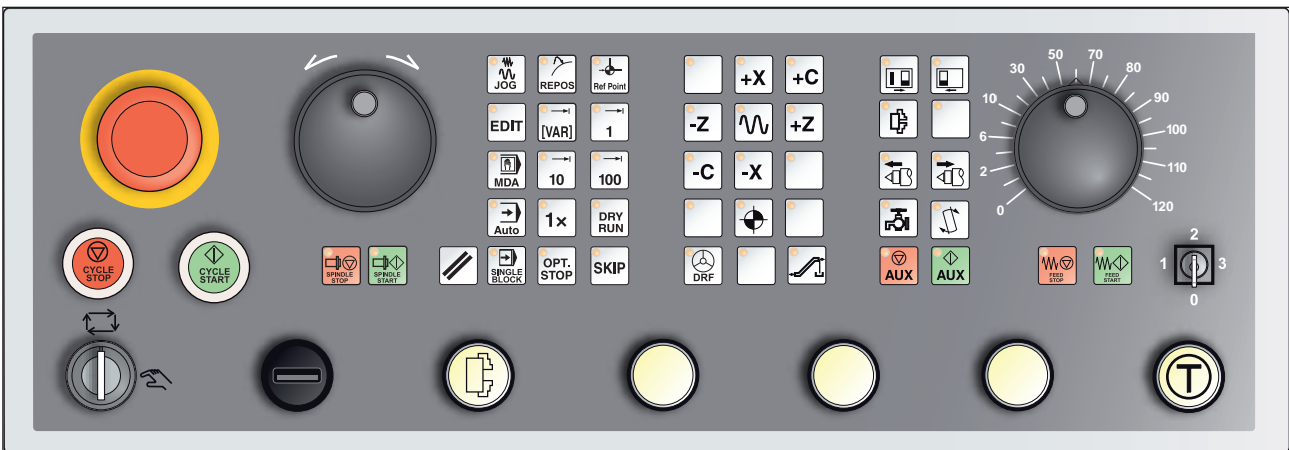

Machine control panel variant with Easy2Control and MOC-Touch

Key description

Skip (block mask)



In Skip mode, program blocks will be jumped over when the program is running.

Dryrun (test-run feed)



In Dry-run mode, positioning movements will be carried out with the dry-run feed.

The dry-run feed works instead of the programmed movement commands.

On starting the NC program, the main spindle will not be activated and the slides will move with dry-run feed speed.

Only perform the test run without a workpiece to avoid the danger of collisions.

If the test run is engaged, the test "DRY" appears in the simulation window.

Instructions:
The buttons for the Concept Turn 250 machine are explained below. For others machines always take note of Chapter D EMCO-specific Programming and Operation in the operating manual.



Individual piece mode



This button makes individual piece mode or constant operation in conjunction with automatic loading equipment available for selection. Individual state is the default state when switched on.

Optional stop



When this function is active, program processing will stop at blocks in which the M01 special function has been programmed. You start processing again with the NC Start button. If the function is not active, the M01 special function will be ignored.

Reset key (Reset)



- A running program or a movement will be broken off.
- Alarm notifications will be cleared.
- The control system is in the starting position and ready for a new program sequence.

Single block



This functions allows you to execute a program block by block. The Single Block function can be activated in the automatic mode (a program will be executed automatically) operation type.

When single block processing is active:

- SBL" (=SingleBlock) is shown on the screen.
 - the current block of the part program is only processed when you press the NC Start button.
 - processing stops after a block is executed.
 - the following block is executed by pressing the NC Start key again.
- The function can be deselected by pressing the Single Block key again.

NC Stop



After pressing the NC Stop button the execution of the running program will be broken off. Processing can then be continued by pressing the NC Start button.

NC Start



After pressing the NC Start key the selected program will be started with the current block.

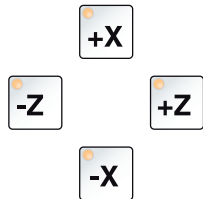

Arrow keys

With these buttons, the NC axes can be moved in JOG operation mode.



Reference point

Pressing this button causes the reference points to be approached in all axes.



Rapid Traverse

If this function is pressed in addition to the movement buttons, the axes concerned move in rapid traverse.



Feed Stop

In "AUTOMATIC" operation mode, this function cancels a slide movement.



Feed Start

This function resumes a programmed slide movement which has been interrupted.
If the main spindle motion was also broken off, it must be switched on first.



Spindle speed correction

The set spindle speed value S will be shown on the screen as an absolute value and as a percentage.
Effective for the main spindle or for the spindle for the driven tools (if present).

Adjustment range: 50 - 120% of the programmed spindle speed
Increment: 5% per button press
100% spindle speed: 100% button



Spindle Stop

This function interrupts the motion of the main spindle. If it happens during a feed movement, that has to be stopped first.



Spindle Start

This function resumes the programmed spindle motion.



Automatic machine doors

To open and close the machine doors.

Chip conveyor (Option)



Switch on chip conveyor:

Forwards: Press button for less than 1 second.

Backwards: Press button for longer than 1 second.

The chip conveyor will be switched off after a defined time (approx. 35 seconds).

This value is set in the factory.

Clamping device



This button activates the clamping device. For chuck/pliers change-over see "Machine configuration".

Via NC program

M25 Open clamping device

M26 Close clamping device

Manual tool change



Pressing this button starts a manual tool change.

The clamped tool can now be removed and replaced.

Preconditions:

- Machine doors closed
- "JOG" operating mode
- Key switch in "Hand" position

Information:

- Interrupt the change process by moving the override switch below 4%.
- Cancellation of the change procedure by pressing the reset button.



Tailstock forwards, tailstock backwards



These buttons move the tailstock forwards or backwards.

Coolant



This function switches the coolant equipment on or off.

Auxiliary OFF



This function switches off the machine's auxiliary unit. Only effective if spindle and program are off.

Auxiliary ON



This function makes the machine's auxiliary unit ready for operation (e.g.: hydraulics, feed drives, spindle drives, lubrication, chip conveyors, coolant).

The button must be pressed for around 1 second.

Briefly pressing the AUX ON button is a quit function and causes the central lubrication system to perform a lubrication impulse.

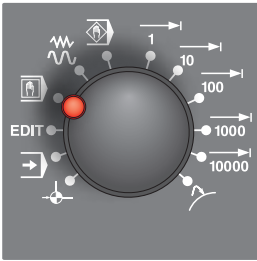

Types of operation

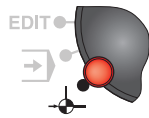

REF - Reference mode

Approaching the reference point (Ref) in the JOG operating mode.



AUTO - Automatic mode

Control the machine by automatically executing programs. Here part programs are selected, started, adjusted, deliberately influenced (e.g. individual block) and executed.

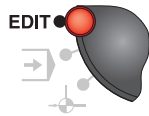

EDIT

no function



MDA - Semi-automatic mode

Control the machine by executing a block or a sequence of blocks. Block input is performed via the operating panel.



JOG - Jogging

Standard movement of the machine by continuous movement of the axes via the directional buttons or by incremental movement of the axes via the directional buttons or the handwheel.

JOG is used in manual mode as well as for set-up of the machine.



TEACH IN

no function



Inc 1 - Incremental feed

Move step by step a predefined distance of 1 increment.

Metrical measurement system: Inc 1 corresponds to 1µm

Imperial (inch-based) measurement system: Inc 1 equates to 0.1 µinch



Inc 10 - Incremental feed

Move step by step a predefined distance of 10 increments.

Metrical measurement system: Inc 10 corresponds to 10µm

Imperial (inch-based) measurement system: Inc 10 equates to 1 µinch



Inc 100 - Incremental feed

Move step by step a predefined distance of 100 increments.

Metrical measurement system: Inc 100 corresponds to 100µm

Imperial (inch-based) measurement system: Inc 100 equates to 10 µinch

**Inc 1000** - Incremental feed

Move step by step a predefined distance of 1000 increments.
 Metrical measurement system: Inc 1000 corresponds to 1000µm
 Imperial (inch-based) measurement system: Inc 1000 equates to 100 µinch
 (equates to 1 mm)

**Inc 10000** - Incremental feed

- Move step by step a predefined distance of 10,000 increments.

Metrical measurement system: Inc 10000 corresponds to 10000µm
 Imperial (inch-based) measurement system: Inc 10000 equates to 1000 µinch
 (equates to 10 mm)

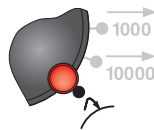
**REPOS** - Repositioning

Back-positioning, approach contour again in the JOG operating mode

Information:

- The operating modes can be selected via softkeys (PC keyboard) or with the operating mode selector switch.
- Switching between the metrical measurement system and the imperial (inch-based) measurement system is carried out with the EmConfig utility software (see Chapter X EmConfig).

Instructions:

Metric is assigned in the imperial measuring system as follows:

Feed:

Millimeters in inches:
 mm/min => inches/min
 mm/U => inches/U

Constant cutting speed:

Meters in feet:
 m/min => feet/min

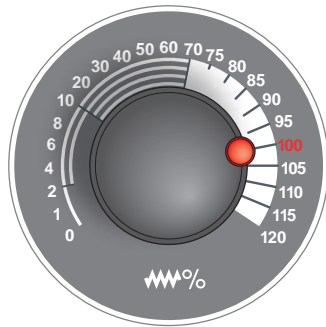

Override switch (feed rate override)

The rotary switch with notch positions changes the programmed feed value F (corresponds to 100%).
The set feed value F in % will be shown on the screen.

Adjustment range:

0% to 120% of the programmed feed.

In rapid traverse 100% will not be exceeded.

No effect with thread commands G33, G63

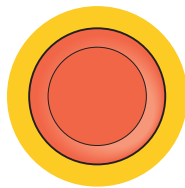

EMERGENCY STOP

Press the red button only in an emergency.

Effects:

As a rule, the EMERGENCY STOP button will lead to all drives being stopped with the greatest possible braking torque.

To continue working, press the following buttons:

RESET, AUX ON, doors OPEN and CLOSED.

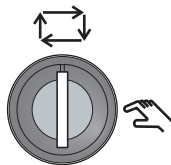

Key Switch Special Operations Mode

The key switch can be switched to the "AUTOMATIC" or "SET-UP" (hand) position.

With this key switch it is possible to perform movements in Jog Mode when the sliding door is open.



Danger:

When Special Operations mode is active, the danger of accidents is increased.

The key for this switch should only be held by persons who have the required knowledge about the dangers and exercise appropriate care.

Keep the chip guard door closed even in Set-up mode.

Keys should only be used by authorized persons.

After work is carried out in Special Operations mode, always withdraw key (accident danger).

Observe country-specific safety instructions (e.g.: SUVA, BG, UVV ...).

Multifunction switch for operating modes

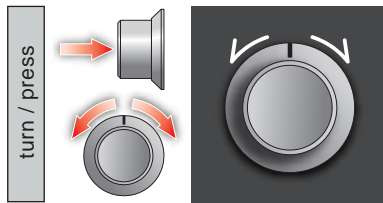

The multi-function switch is designed as a rotary switch with a press feature.

Populated function

- The user interface is opened by pressing the multifunction operation. The active function is indicated by a green check-box.
- Turning the switch allows you to switch between the functions. The black bar with the symbols moves to the left or to the right.
- Activating a function or a change to a sub-menu is executed by pressing the button.

The interface offers the following functions:

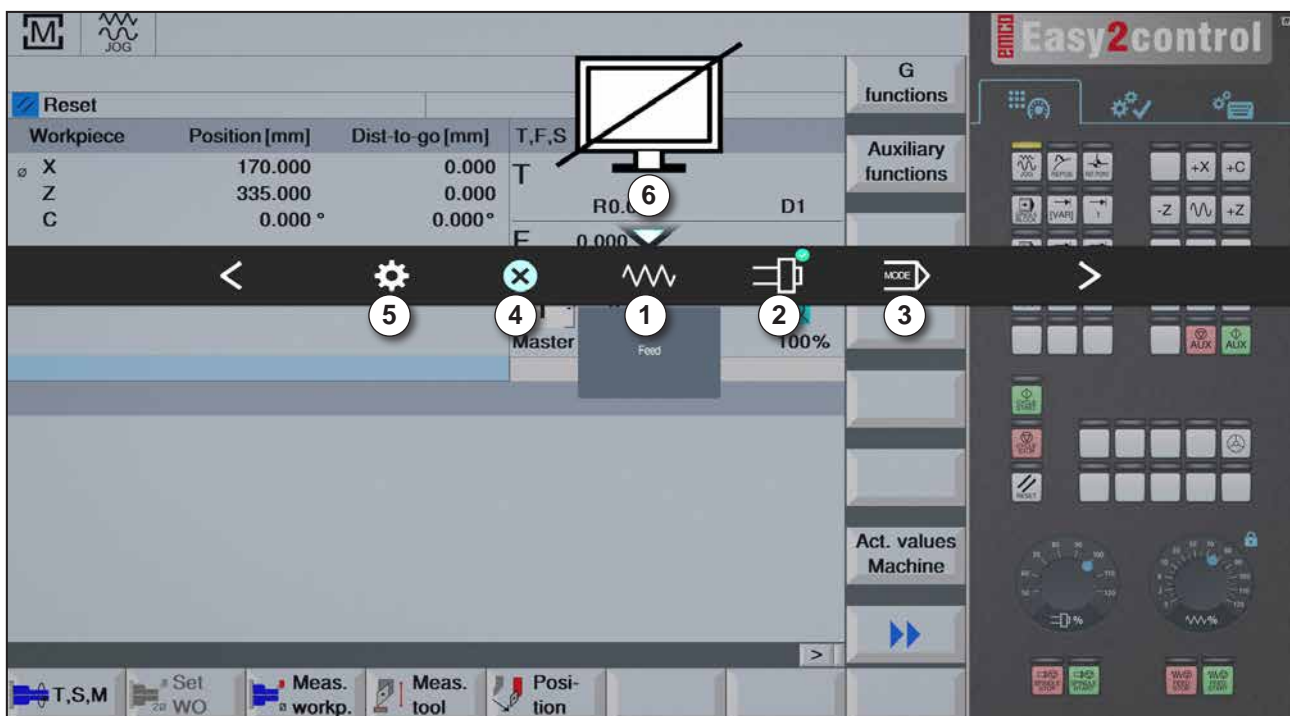

Overview

- | | |
|-------------------------------------------------------------------------------------------------------------------------------------------------------------------------------------------------------------------------------------------------------------------------------------|--------------------------------------------------------------------------------------------------------------------------------------------------------------------------------------------------------------|
| <p>1 Feed override: controls the feed rate equivalent to conventional feed override</p> <p>2 Spindle override: controls the spindle speed equivalent to conventional spindle override</p> <p>3 Modes: allows you to select the operating mode using the multifunction operation</p> | <p>4 Close: The user interface is closed. The menu disappears, return to the control surface</p> <p>5 Settings: opens another level with settings</p> <p>6 Cursor: shows the actual position in the menu</p> |
|-------------------------------------------------------------------------------------------------------------------------------------------------------------------------------------------------------------------------------------------------------------------------------------|--------------------------------------------------------------------------------------------------------------------------------------------------------------------------------------------------------------|

Note:

The functionality of the multifunction operation is depending on the installed software version.



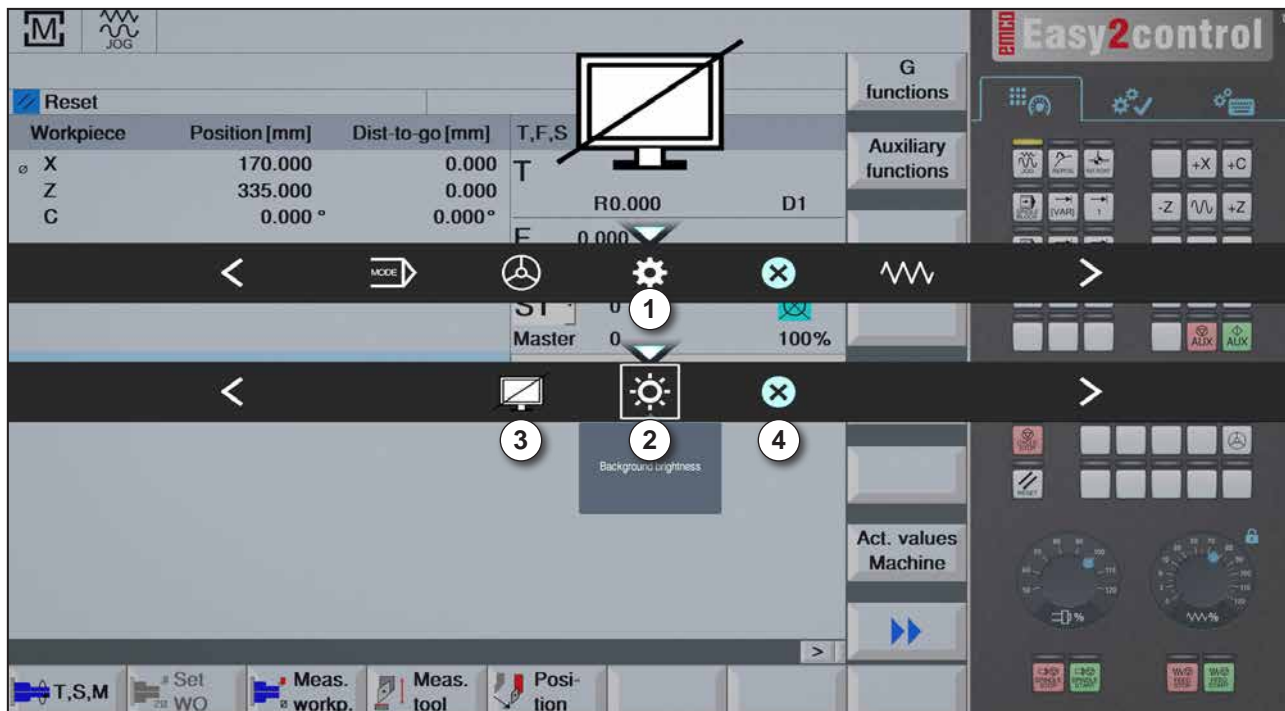

Settings the background brightness

1 Settings

2 Background brightness: adjusts the transparency of the background

3 Lock screen: press again unlocks the screen.

4 Close: closes the submenu and returns to a higher-level menu.

Setting the background transparency



- By pressing once, a white border around the icon appears. The menu item is activated.



- Now, the transparency of the background can be changed by turning the rotary switch:
Turn to the left: brighter
Turn to the right: darker
- Press again closes the menu and the white border disappears.

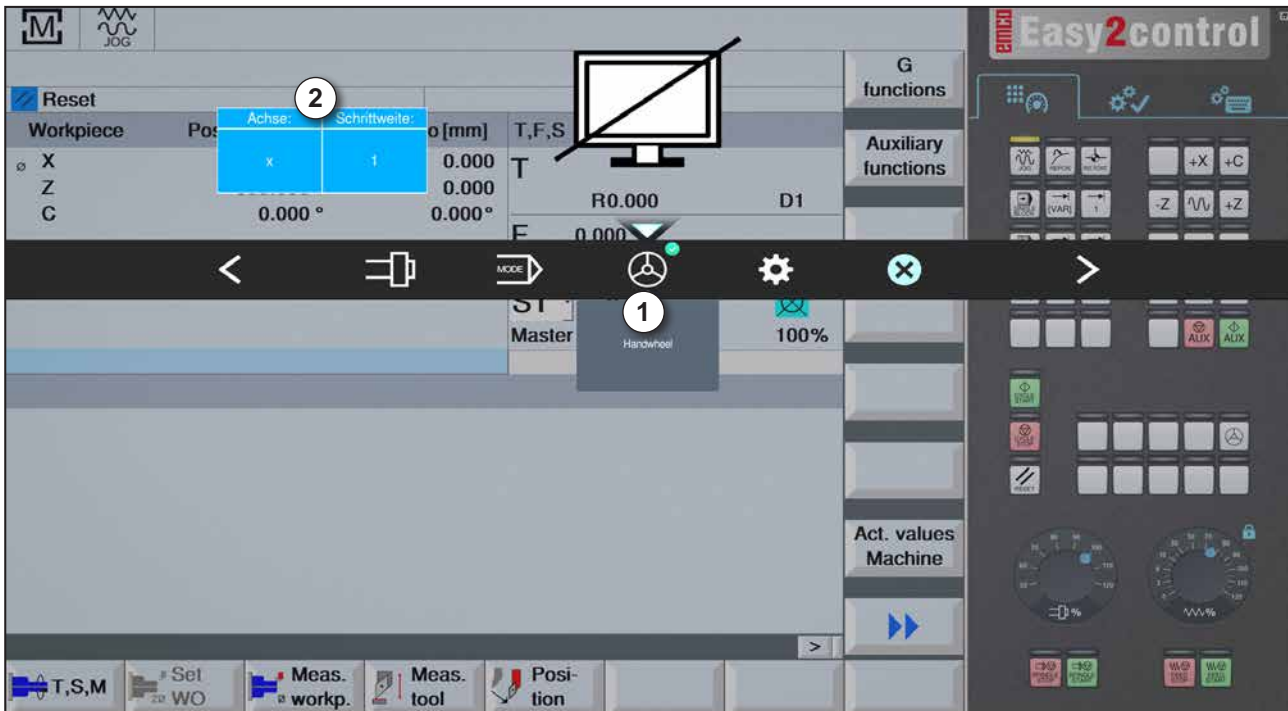

Handwheel function

The handwheel (1) activates the handwheel mode. The parameters for axis and step width (2) are set with the axis- and operating-mode buttons on the machine keyboard.

Operation

- The electronic handwheel is used to traverse the slides at a defined step width.
- The step width depends on the selected Inc mode: Inc 1, Inc 10, Inc 100.
- There must be one pre-selected Inc mode and an axis defined by a direction key.
- Also refer to "types of operation" und "arrow keys" in chapter B.

Note:

In the mode "Inc 1000" the slides cannot be moved with the handwheel. "Inc 1000" operates with "Inc 100".

0



1

Key switch

The key switch function is machine-specific.

Additional NC start button



The additional button has the same function as on the machine control panel.
(Double movement because of better operation).



USB connection (USB 2.0)

Data is exchanged with the machine (data copying, software installation) via this USB connection.



Enable button

When the door is open, axis movements via direction buttons and tool changer movements are authorized by pressing the enable button (precondition key switch in SET-UP position).
In machines with automated doors (option) pressing the enable switch opens the machine doors.

C: Operation

Feed F [mm/min]

The feed F is the speed in mm/min (feet/min) with which the tool center point moves on its path. The maximum feed can be different for each machine axis and is defined by machine parameters.

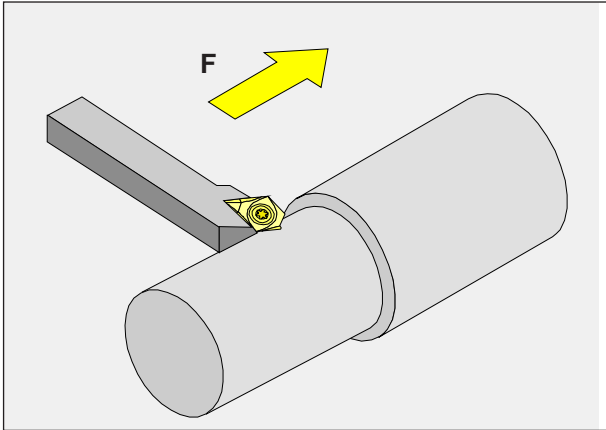

Feed influence

The feed value F programmed by you corresponds to 100%. With this button or with the feed override the set feed value F can be changed in %.

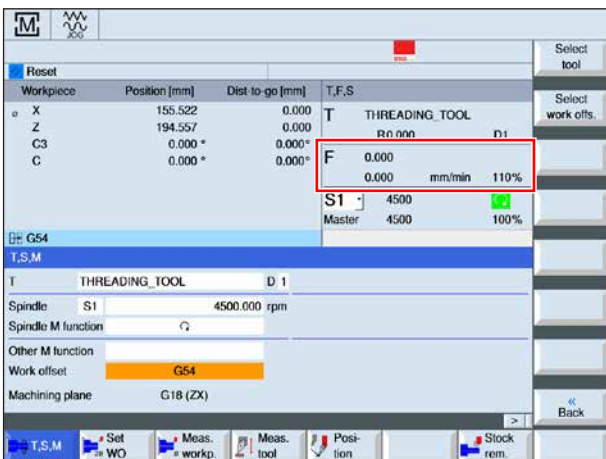

Adjustment range:

0% to 120% of the programmed feed. Only the changed percentage and not the resulting effective value will be shown. In rapid traverse 100% of the maximum rapid traverse feed will not be exceeded.

Speed fundamentals

You choose between the following procedures:

- **Spindle speed S:**
You program the spindle speed directly. The spindle speed is independent of the diameter on which the tool works.
- **Constant Cutting Speed CCS:**
You program the spindle speed indirectly. The control system changes the speed depending on which diameter the tool is working directly. In this way a constant cutting speed will be achieved.

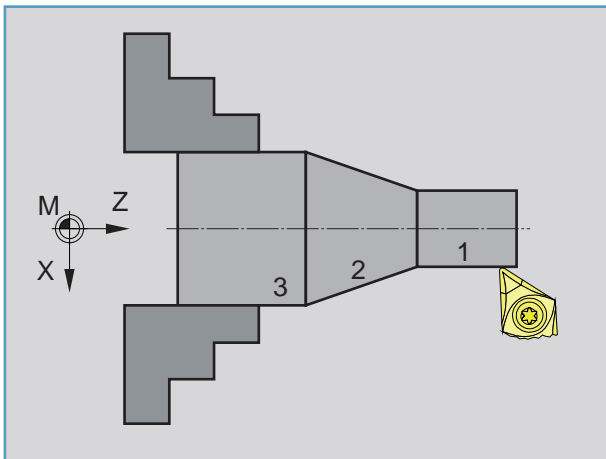

Example:

- **Spindle speed S:**
Section 1 to 3: same speed.
- **Constant Cutting Speed CCS:**
Section 1: high speed.
Section 2: constantly increasing speed.
Section 3: low speed.

Spindle speed S [rev/min]

Indicate the spindle speed S in revolutions per minute (rpm).

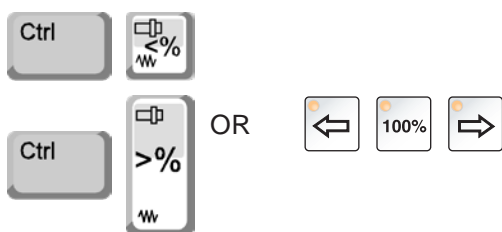
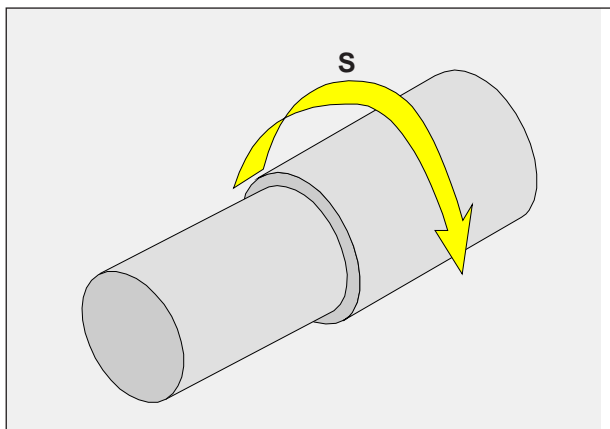

Spindle speed correction

The spindle speed S programmed by you corresponds to 100%.

With these button combinations or with the spindle speed override the set spindle speed value S can be changed in %.

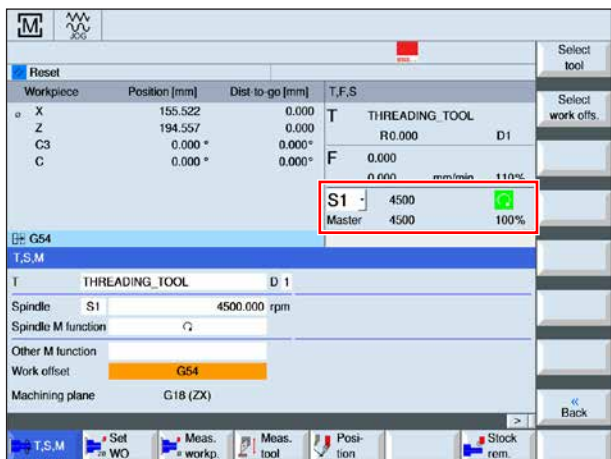

Adjustment range:

0% to 120% of the programmed spindle speed.

Only the changed percentage and not the resulting effective value will be shown.

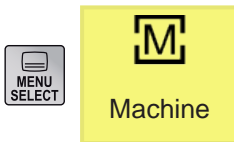

Machine

Machine operating area

The machine operating area includes all functions and influence variables that lead to actions on the tool machine or its state.

The following operating modes are distinguished:



OR



Types of operation

JOG - Jogging

Standard movement of the machine by continuous movement of the axes via the directional buttons or by incremental movement of the axes via the directional buttons or the handwheel.

JOG is used in manual mode as well as for set-up of the machine.



OR



MDA - Semi-automatic mode

Control the machine by executing a set or a sequence of sets. Block input is performed via the operating panel or the PC keyboard.



OR



AUTO - Automatic mode

Control the machine by automatically executing programs.

Here part programs are selected, started, adjusted, deliberately influenced (e.g. individual set) and executed.

Instructions:

The operating modes can be selected via softkeys (PC keyboard) or with the operating mode selector switch.



The following options exist for JOG mode set-up.



OR



REF - Reference mode

Approaching the reference point (Ref) in the JOG operating mode.



OR

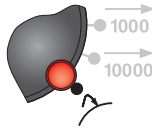

REPOS - Repositioning, approach contour again in the JOG operating mode



Inc 1 - Incremental feed

Move step by step a predefined distance of 1 increment.

Metrical measurement system: Inc 1 corresponds to 1µm

Imperial (inch-based) measurement system: Inc 1 equates to 0.1 µinch



Inc 10 - Incremental feed

Move step by step a predefined distance of 10 increments.

Metrical measurement system: Inc 10 corresponds to 10µm

Imperial (inch-based) measurement system: Inc 10 equates to 1 µinch



Inc 100 - Incremental feed

Move step by step a predefined distance of 100 increments.

Metrical measurement system: Inc 100 corresponds to 100µm

Imperial (inch-based) measurement system: Inc 100 equates to 10 µinch



Inc 1000 - Incremental feed

Move step by step a predefined distance of 1000 increments.

Metrical measurement system: Inc 1000 corresponds to 1000µm

Imperial (inch-based) measurement system: Inc 1000 equates to 100 µinch



Inc 10000 - Incremental feed

Move step by step a predefined distance of 10,000 increments.

Metrical measurement system: Inc 10000 corresponds to 10000µm

Imperial (inch-based) measurement system: Inc 10000 equates to 1000 µinch

Instructions:

Metric is assigned in the imperial measuring system as follows:

Feed:

Millimeters in inches:

mm/min => inches/min

mm/U => inches/U

Constant cutting speed:

Meters in feet:

m/min => feet/min



Approach reference point

The reference point R is a specified fixed point on the machine. It is used to calibrate the measurement system.

The reference point must be approached each time after the machine is switched on or the EMERGENCY STOP button is unlocked, in order to make the exact distance between the machine zero point M and the tool fixture reference point N or T known to the control system.



- Switch to the reference mode REF.



Option A:

Reference the axes individually

Press the +Z and +X buttons.

The slides move one another to their reference points, after each has reached the collision-free area.

Instructions:

- After reaching the reference points the software limit switches are active. The reference point position will be shown as the current position on the screen.
- The tailstock (if available) must be at the right end of the bed when referencing the axes, so that the Z-slides do not collide with the tailstock.



Option B:

Reference automatically

Pressing the button "Reference point" causes the axes to approach their reference points automatically one after another. First the axes then the tool changer will be referenced.

Move slides manually



The machine axes are moved manually using the direction buttons.

- Switch to JOG mode.



- The direction buttons move the axes in the corresponding direction as long as the button is pressed.

- The feed speed is set with the override switch.



- If the button is pressed simultaneously, the slides move in rapid traverse.

Move slides in step-movement

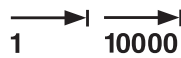

The machine axes can be moved in steps using the direction buttons.

- Switch to INC mode.



- The direction buttons move the axes in the corresponding direction by the set step distance each time the button is pressed.

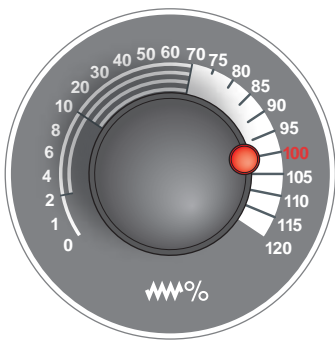

- The feed speed is set with the override switch.

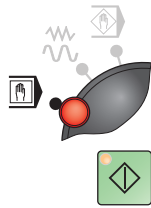

- If the button is pressed simultaneously, the slides move in rapid traverse.

**MDA mode - Semi-automatic mode**

Control the machine by executing a set or a sequence of sets. For this the desired movements can be entered via the control keyboard in the form of part program sets.

The control system executes the blocks entered after the control button is pressed.

For running an MDA program, the same preconditions are necessary as for fully automatic mode.

**AUTO mode - Automatic mode**

Control the machine by automatically executing programs. Here part programs are selected, started, adjusted, deliberately influenced (e.g. individual set) and executed.

Preconditions for executing part programs:

- The reference point was approached
- The part program is loaded into the control system.
- The correction values required were checked or entered (e.g. zero point offsets, tool corrections)
- The safety locks are activated (e.g. chip-guard doors closed).

Options in Automatic mode:

- Program correction
- Block search run
- Overstore
- Program influence

(see Section G program sequence)



Screen division T, S, M

<div style="display: flex; justify-content: space-between;"> M JOG </div>				EMCO		8 Select tool	
<div style="display: flex; justify-content: space-between;"> Reset </div>						9 Select work offs.	
Workpiece	Position [mm]	Dist-to-go [mm]	T,F,S				
∅ X	155.522	0.000	T 1 THREADING_TOOL				
Z	194.557	0.000	R0.000	D1			
C3	0.000 °	0.000 °	F 0.000				
C	0.000 °	0.000 °	0.000 mm/min	90%			
			S1	4500	↻		
			Master	4500	100%		
<div style="display: flex; justify-content: space-between;"> G54 </div>							
T,S,M							
T	2 THREADING_TOOL		D 1	3			
Spindle	S1	4500.000 rpm	4				
Spindle M function	↻		5				
Other M function	6						
Work offset	G54		7				
Machining plane	G18 (ZX)		10				
>							
<< Back							
T,S,M		Set WO	Meas. workp.	Meas. tool	Position	Stock rem.	

- 1 Tool name
- 2 Current tool place number
- 3 Current tool cutting number
- 4 Spindle speed
- 5 Spindle direction of rotation (M3, M4, M5, SPOS)
- 6 Input option for additional M-functions
- 7 Zero point offset selection
- 8 Softkey to switch to the tool list
- 9 Softkey to switch to the table for zero point offsets
- 10 Infeed movements are made at right angles to the machining plane

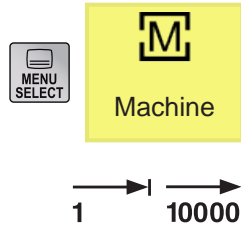

Move Axes

Move axes by fixed increments

- 1 Switch to the machine operating area.
- 2 Select INC setting on mode rotary switch to set the increment. 1, 10, ..., 10000.

Example increment 1
 equals 1 µm in the metric system and
 equals 0.1 µinch in the imperial system

Example increment 100
 equals 100 µm in the metric system and
 equals 10 µinch in the imperial system



- 3 Select axes to be moved.
 With each press the desired axis will be moved by the fixed increment.



Move axes by fixed increments

- 1 Switch to the machine operating area.
- 2 Press softkey. Enter desired value for the variable step distance.
 With each press the desired axis will be moved by the fixed increment.
 Example: For a desired increment of 500 µm (0.5 mm) enter 500.

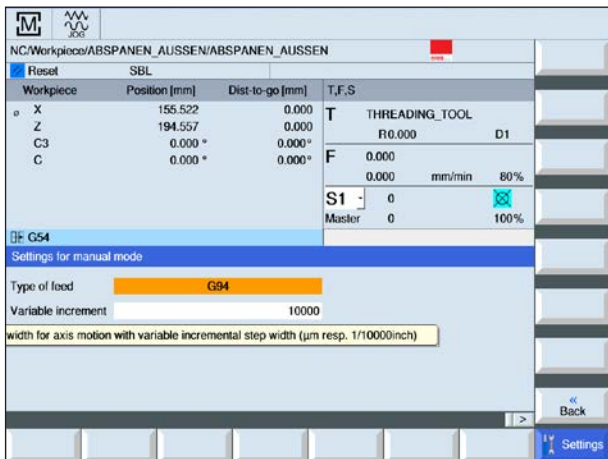
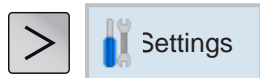

- 3 Set operating mode INC-Var via PC keyboard.
- 4 Select axes to be moved.
 With each press the desired axis will be moved by the fixed increment.



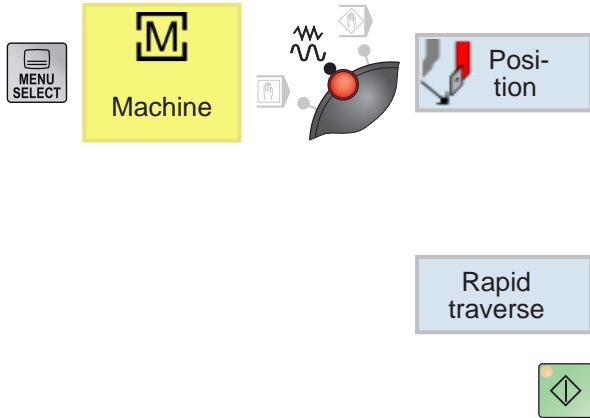

Approach target position

1 Enter the desired coordinate value

2a Enter the desired feed.

OR

2b Select rapid traverse.

3 Use the NC-Start button to move the axes with the set speed to the target position.

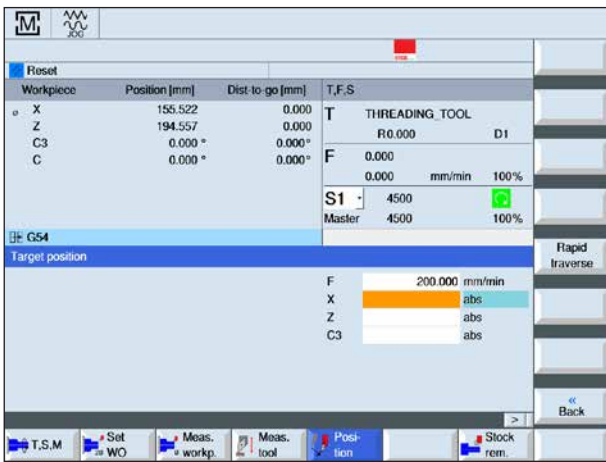

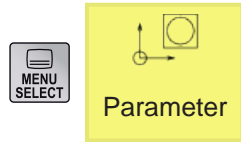

Parameters operating area

In the Parameters operating area, you enter and edit the data for programs and tool management.

Tool data

(see Chapter F Tool Programming)

Zero point offset

- Press Softkey.
- (See Chapter A Zero point offset Fundamentals)

Display and process zero point offset

1 Press softkey. The associated window will be opened.

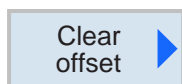
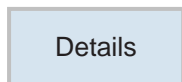
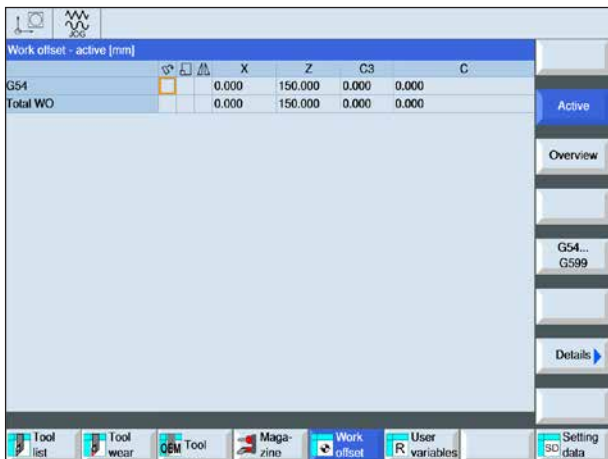
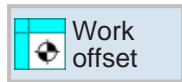

2 To learn more about the shift move the cursor to the desired shift.

3 Press softkey. All configurable shifts will be shown, divided into crude and fine shift, and rotation, scaling and mirroring. Fields with a bright background can be edited.

4 Press softkey to select the next or the previous shift.

5 Press softkey to delete values.

6 Confirm or cancel delete with softkey.

Show overview of zero point offsets

- Press Softkey. All zero point offsets will be shown.

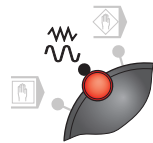
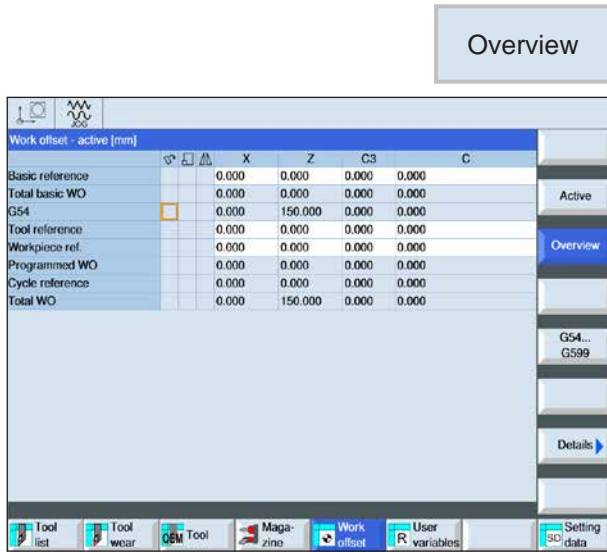

Measure workpiece zero point

- Set operating mode selection switch to JOG mode.

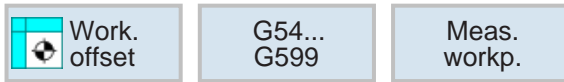

OR

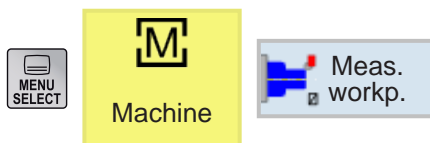

- Press Softkey. The associated window will be opened.



Calculate

Select work offs.

In manual

Set WO

Set edge

The workpiece is in the spindle, parallel to the coordinate system. A reference point will be measured in one of the axes (X, Y, Z). Manual measurement is carried out by scratching a tool on the workpiece.

1 Different measurement options to be selected:

- Select Measure only if measured values should only be shown,

OR

- Select zero point offset if the adjustable zero point offset should be saved,

2 Enter the reference position of the workpiece edge in textbox Z0. Take the reference position from the measurement details of the workpiece drawing.

3 If the pure measurement option was selected, the values will be calculated by pressing the softkey and then shown on the screen.

4 For the zero point offset selection option: Press softkey and select G-command under which the measurement values should be saved.

5 Apply selection with softkey. The selected G-command will be shown.

6 Apply the measurement values with the softkey. This will enter the measured values in the previously selected G-command.

R-parameters (calculation parameters)

Under the address R in the Sinumerik Operate control system there are 300 calculation variables (= R-parameters) of type REAL available by default.

Press softkey to go to the R-parameter table. It is possible to browse through the parameter list with the cursor buttons.

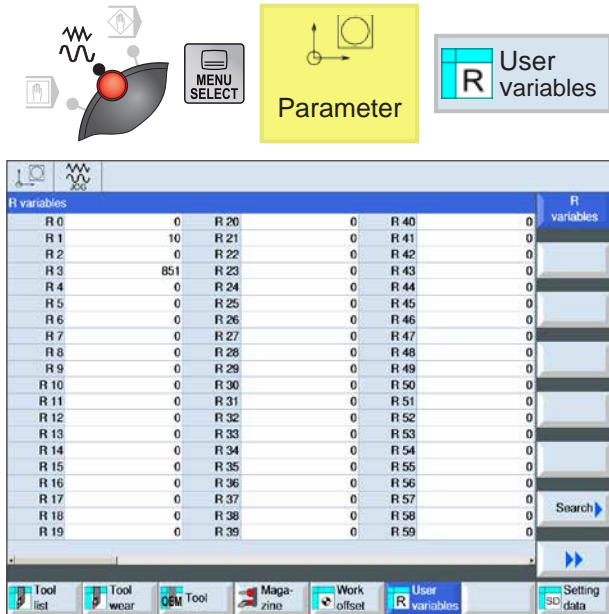

Search R-parameters

To search, press the softkey and enter the desired parameter address.

Confirm search with softkey.

Delete R-parameters

Press softkey to delete and enter parameter addresses to be deleted from R... to R...

Confirm or cancel delete with softkey.

Delete all R-parameters

The softkey deletes all values.

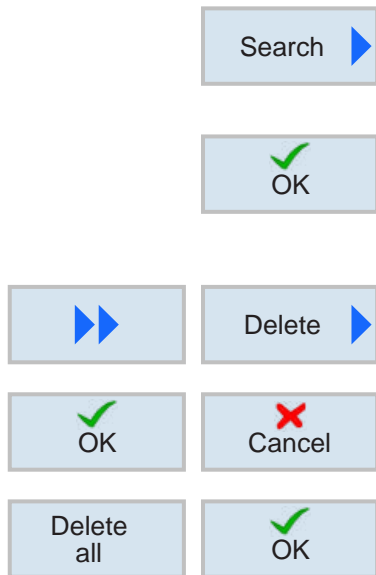

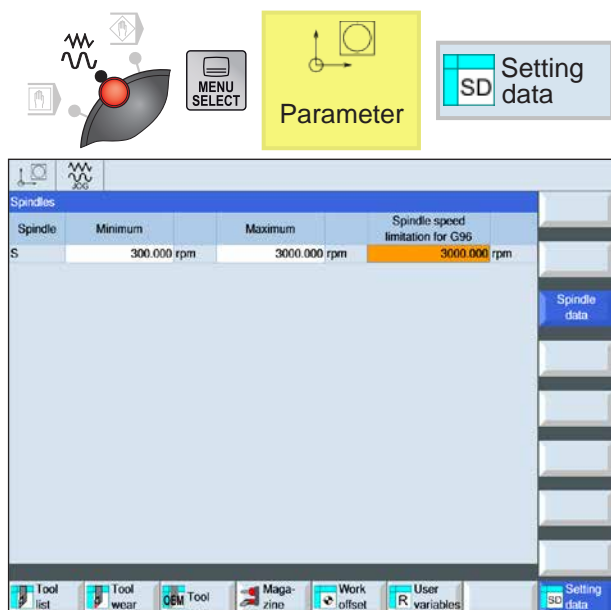

Setting data

Press the softkey to open the window for the setting data.

The following spindle data can be entered:

- Minimum
- Maximum
- Spindle speed limitation for G96

Program management

A program consists of a succession of cycles, commands and/or sub-routines. Press the softkey to go to program management.

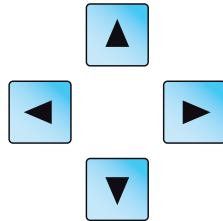

You can navigate between the directories and programs using the mouse or cursor keys. A selected and thus active program is represented with a green symbol.

The following options are available from the program management screen:

- Create program
- Delete program
- Copy program
- Change program
- Select/deselect program on the machine

Instructions:
 There is no restriction on the number of characters for the length of the file name. The number of characters is dependent on the operating system or on the file system.

Type	Name
DIR	Directory for parts or sub-routines or workpieces. Other directories can be created.
WPD	Tool directory. No additional directories can be created.
MPF	Main program
SPF	Sub-routine



Where programs are saved

Programs can be saved in and invoked from the control system's program directory, a local drive or a USB data storage device.

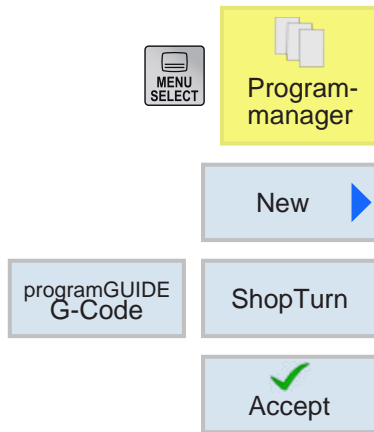

Create program

- 1 Select "Program manager".
- 2 Press softkey.
- 3 Choose whether a ShopTurn/ShopMill or a G-Code program should be created.
- 4 Enter program name and confirm with softkey. If the program name already exists the softkey remains deactivated.

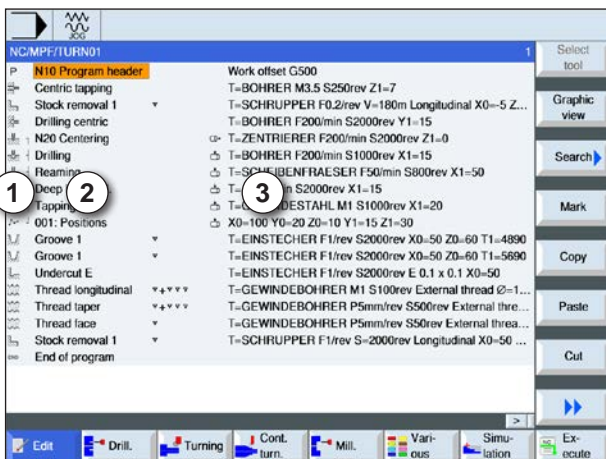
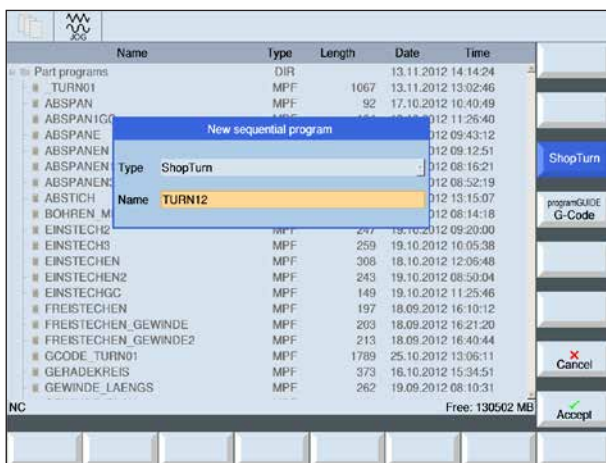

- 1 Cycle symbols
- 2 Program head nomination
- 3 Technology values

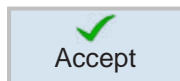

Instructions:
The individual cycles of a program will be shown symbolically in the indicated sequence (1) on the left next to the program header (2).

- 5 Then cycles or program lines can be entered (see Chapter D Programming ShopMill or Chapter E Programming G-Code).
- 6 Press softkey to apply the cycle in the workpiece program.
- 7 Enter additional cycles.
- 8 Select or simulate cycles via softkeys.

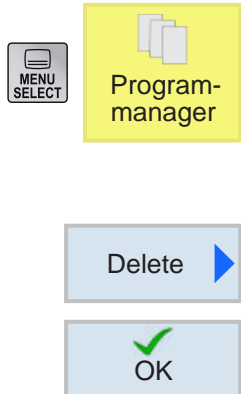

Delete program

Only deselected programs can be deleted. See chapter C Select program. Therefore to delete an active program another program must initially be selected in order to delete the original.

- 1 Press softkey to delete.
- 2 Confirm selection with softkey.



Copy program

- 1 Move mark to the desired program.
- 2 Press softkey to copy.
- 3 Press softkey to paste.

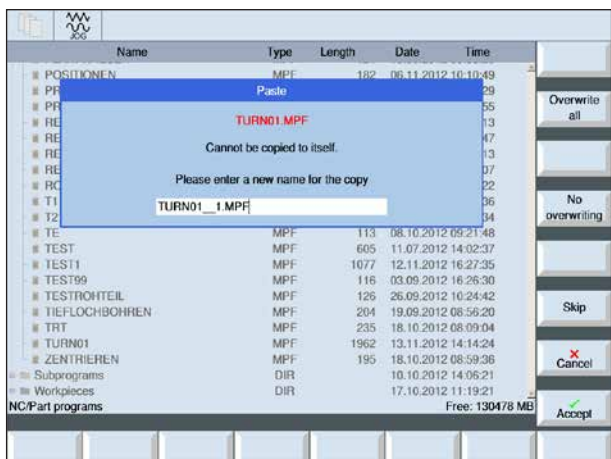

- 4 Enter a new program name or select a program name suggested by the control system.

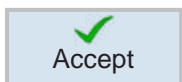

- 5 Press softkey to apply.

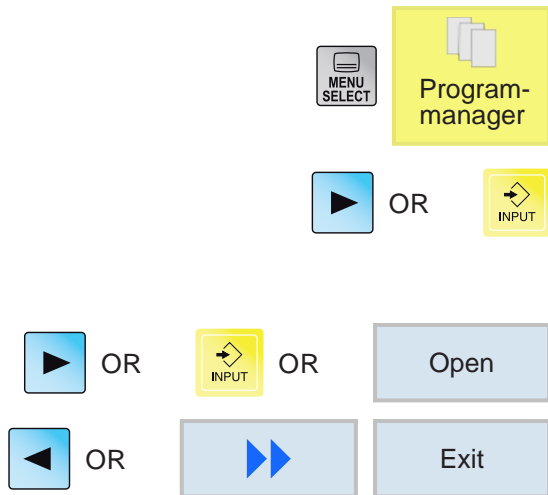

Open / close program

- 1 Position cursor on directory in which the program should be selected.
- 2 Press button.
- 3 Position cursor on the desired program.
- 4 Press button or softkey.
- 5 Press button or softkeys to close.

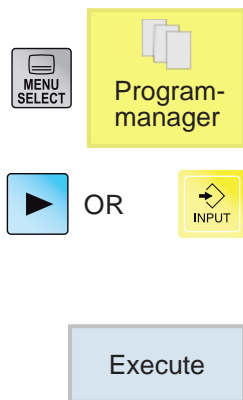

Select / deselect program

- 1 Position cursor on directory in which the program should be selected.
- 2 Press button.
- 3 Position cursor on the desired program.
- 4 Press softkey to select.

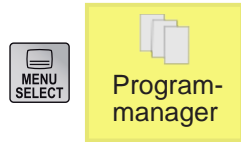

Print program

1 Position cursor on directory in which the program should be selected.



2 Print with Filemanager:
press softkey to print the active NC-programm.



3 Print with ISO-editor:

4 Open an ISO-program.



5 Press softkey to print the opened NC-program.



6 Print with Shop-editor.

7 Open a Shop-program.



8 Press softkey to print the cyclelist of the opened NC-program.



9 Press softkey to print the opened NC-program.

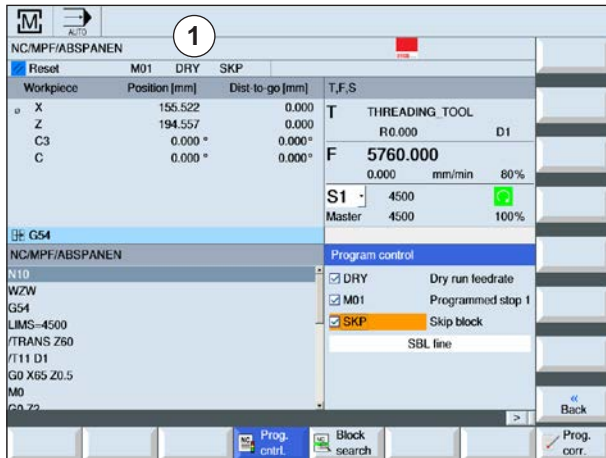
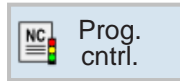

Program influence

In the operating modes "AUTO" and "MDA" selected NC programs can be influenced by the following commands:

- DRY feed test run
- M01 Programmed stop 1
- SKP skip blocks
- SB Single block (SingleBlock SBL)

Active program influences will be shown in the status display (1).

The functions DRY, M01, SKP will be activated by selecting the particular control boxes.

The SB function is activated via the SBL button.



Type of program influence	Description
DRY Feed test run	For test run without workpiece (without chip removal). All blocks for which a feed is programmed (G1, G2, G3, G33, etc.) move with a preset feed test run instead of the programmed feed. The spindle does not run. The test run feed value also applies instead of the programmed feed rotation. Caution: If "Feed test run" is activated, you should not machine a workpiece.
M01 Programmed stop 1	The program processing will stop at each of the blocks in which the M01 special function has been programmed. This is how you do interim checking of the results already achieved on a workpiece. Feed and spindle are stopped. Machine door can be opened. Continue with button
SKP Skip blocks	Skip blocks will be skipped during processing.
SBL Single block	Single block mode with stop after machine function blocks. The program sequence will stop after each movement. Spindle continues turning. Continue with button

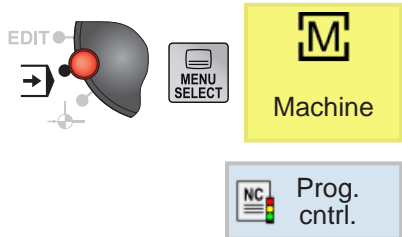

Activate / deactivate program influence for DRY, M01, SB

1 Press softkey.

2 Select control boxes (2). On the screen the active program influences will be shown in the status display (1).

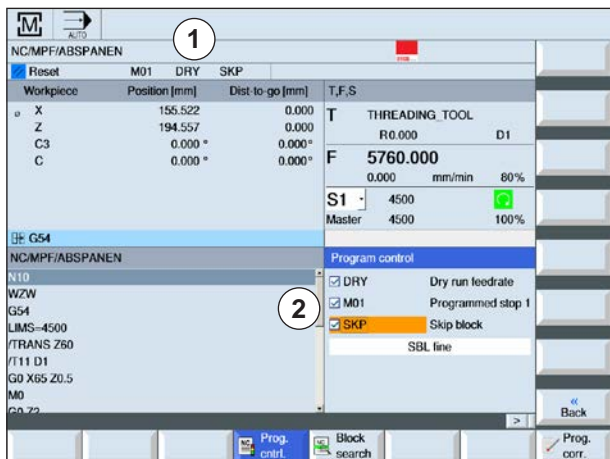

Set feed test run for DRY.

1 Press extension button or softkey.

2 Enter the desired feed test run in the input field (2) and confirm with "Enter". The test run feed will be applied in the T, F, S window (3).

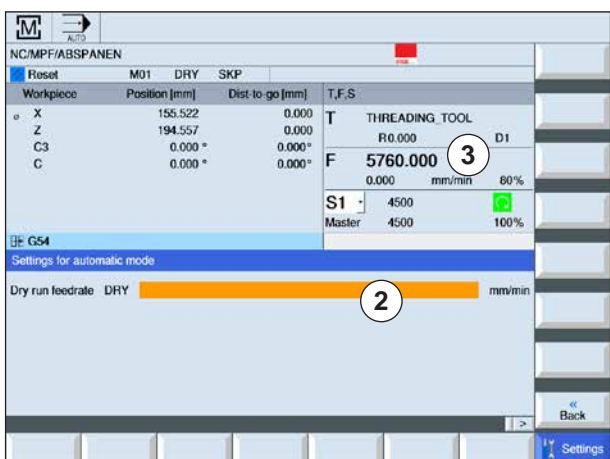
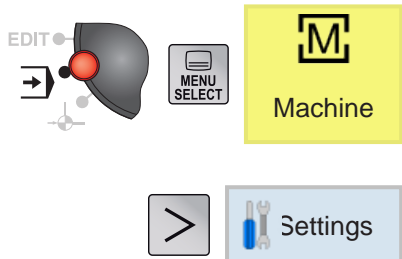

Instructions:
ShopMill or ShopTurn cycles cannot be skipped.

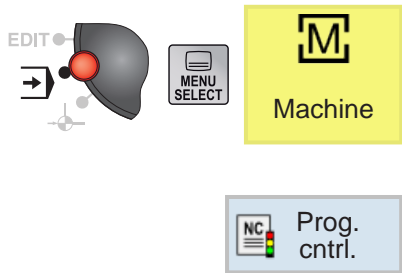
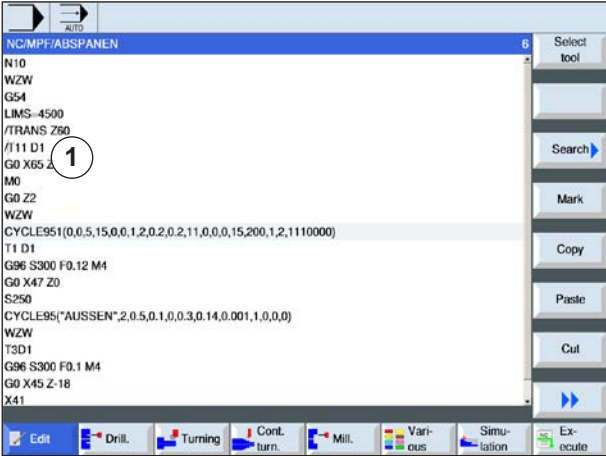

Create skip blocks for program

ISO program blocks that are not executed on every program run can be skipped. These skip blocks are identified by the symbol "/" (slash) in front of the block number. Several blocks can also be skipped in succession. The instructions in the skipped blocks will not be executed, i.e. the program will continue in each case with the next unskipped block.

1 Place "/" character before the block number. After SKP is activated, the highlighted block will be skipped.

2 Press softkey.

3 Select control box SKP (3). On the screen the active program influences will be shown in the status display (2).

3 Press button. The control system only executes program blocks that were not marked with the symbol "/".

4 If the SKP control box is not selected, the entire program will be executed. The program blocks marked with "/" will also be executed.

Execute program in Single Block (SBL)

In SBL the control system executes the program block-by-block.

A program must be selected in "AUTO" mode. The name of the selected program will be shown (1).



1 Press softkey.

2 Press button. On the screen active single block mode (SBL) will be shown in the status display (2).

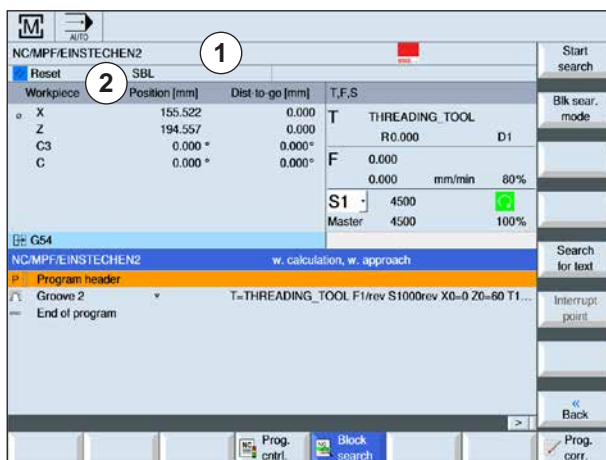

3 Press button. The control system executes the first program block and afterwards stops the processing.



4 Press button again. The control system works on the next program block and afterwards stops the processing.



5 Press button if the processing should no longer take place block-by-block. On the screen the Single Block mode display (2) goes off.

Block search run

The block search run enables a program pre-run to the desired point in the NC program.

The following search target variants are available:

- Define search target with cursor
Direct input of the search target by positioning the cursor in the selected program (main program).
- Define search target by text search.

1 The desired program is selected in "AUTO" mode.

2 The control system is in the reset state.

3 Press softkey.

4a Position cursor on the target block

OR

4b Press softkey to search for text. For this select search direction and enter the text to be searched for.

Confirm with softkey.

5 The search run is started with the softkey. The control system counts through all blocks to the search target, but still carries out no movements.

6 Press NC-Start button.

During the block search run the same calculations will be carried out as in normal program mode (the program will be simulated internally). At the start of the block of the target block the machine state will be established that would also be active in a normal program run.

In the mode "with calculation with approach" the end position of the block before the target block will be approached. The mode is used to be able to approach the contour in arbitrary situations. Afterwards the target block and the following blocks are executed as in a normal program sequence.

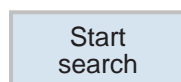
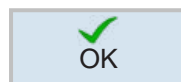
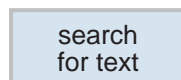

Correct program

A program can only be corrected in the reset state. All lines can be changed here.

A program must be selected in "AUTO" mode.

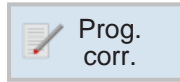

- 1 Press softkey.
The program is opened in the editor and can be processed.

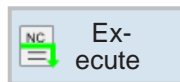
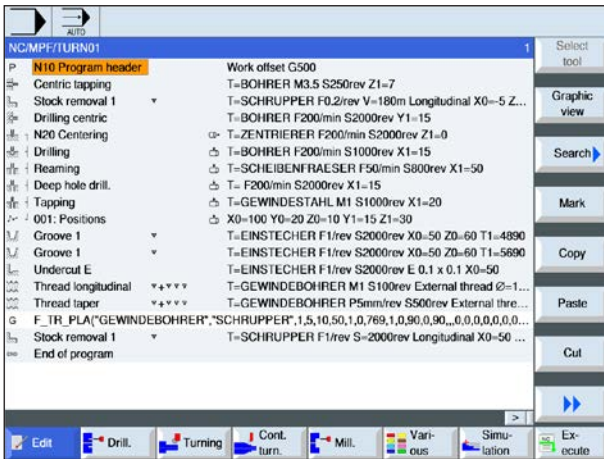

- 2 Perform corrections.

- 3 Press softkey.
The control system switches back into the "Machine" operating area, selects "AUTO" operating mode and is in the block search run..



- 4a Press button. The control system continues to process the program from the prior position.

OR



- 4b "Block search run" starts the block search run from the current program line in the editor.

Show G-functions

Selected G-groups will be shown in the "G-functions" window.

Only a G-function from a G-code group is displayed within a G-group. Some G-codes (e.g. G17, G18, G19) are active immediately after the machine control is switched on. Only G17 or G18 or G19 is always active.



1 Call up "Machine" operating area.

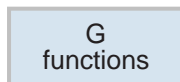

2 Press softkey. The G-functions used in the NC program will be shown in groups.

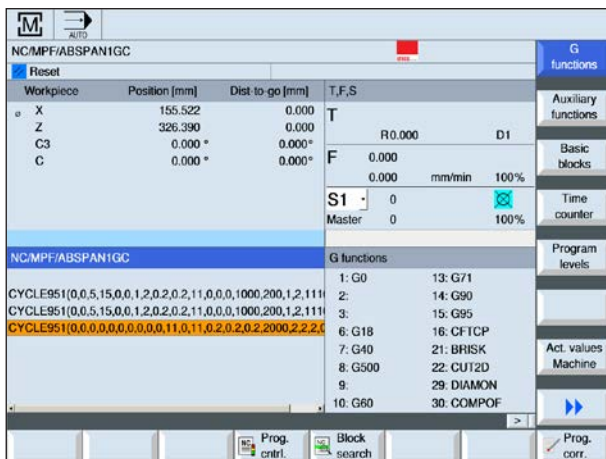

Instructions:

There is an overview of the G-code commands in chapter E: G-code programming





Group	Meaning
G-Group 1	Modally effective movement commands (e.g. G0, G1, G2, G3)
G-Group 2	Block-by-block effective movements, e.g. dwell time (e.g. G4)
G-Group 3	Programmable shifts, work field limitation and pole programming (e.g. TRANS, ROT, G25, G110)
G-Group 6	Plane selection (G17, G18, G19)
G-Group 7	Tool radius correction (G40, G41, G42)
G-Group 8	Configurable zero point offset (e.g. G54, G57, G500)
G-Group 9	Suppression of shifts (e.g. G53)
G-Group 10	Precision stop - path control mode (G60, G64)
G-Group 11	Precision stop by blocks (G9)
G-Group 12	Block switch criteria in precision stop (G601, G602)
G-Group 13	Workpiece dimensioning inch/metric (e.g. G70, G71)
G-Group 14	Workpiece dimensioning absolute/incremental (G90, G91)
G-Group 15	Feed type (e.g. G94, G961, G972)
G-Group 16	Feed correction on internal and external curve (e.g. CFC)
G-Group 17	Approach/withdrawal behavior in tool correction (e.g. NORM, CONT)
G-Group 18	Corner behavior in tool correction (G450, G451)
G-Group 24	Pilot control (FFWOF, FFWON)
G-Group 29	Radius/Diameter programming (e.g. DIAMOF, DIAMCYCOF)
G-Group 30	NC block compression (e.g. COMPOF, COMPON)
G-Group 43	Approach direction WAB (G140, G141, G142, G143)
G-Group 44	Path splitting WAB (G340, G341)
G-Group 49	Point-to-point movement (CP, PTP, PTPG0)

Show all G-functions

All G-groups with their group numbers will be listed in the "G-functions" window.

Inside a G-group the G-function currently active in the control system will always be shown. The following additional information will be shown at the bottom:

- Spindle speed
- Feed
- Active tool (tool name)
- Current zero point offsets
- Current transformation

Active transformation	Description
TRANSMIT 	Polar-Transformation active
TRACYL 	Cylinder jacket transformation active

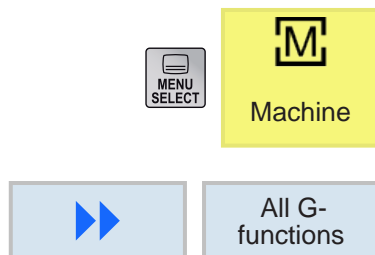

1 Call up "Machine" operating area.

2 Press softkey.

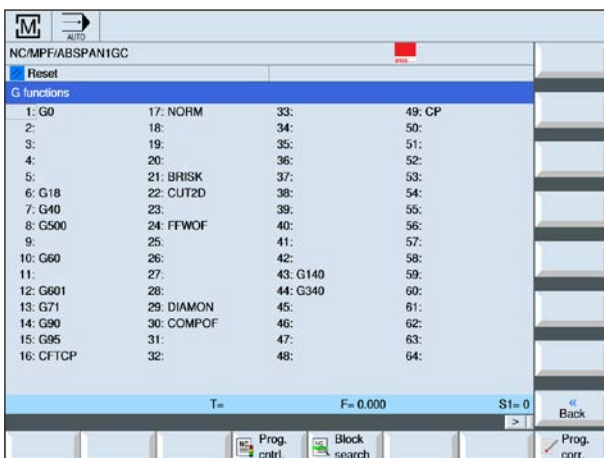

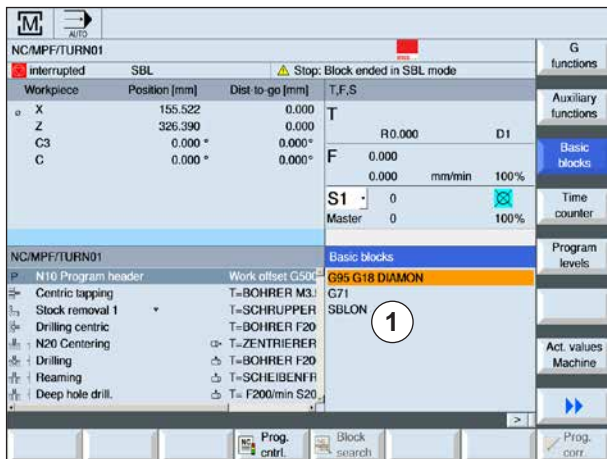

Show basic blocks

The basic block display gives more precise information during the execution of the program. All axis positions and important G-functions are superimposed. If a cycle is executed there can be a test to see which movements the machine actually carries out.

For the currently active program block all G-code commands that trigger a function on the machine will be shown in the window "Basic blocks".

- Absolute axis positions
- G-functions of the first G-group
- Other modal G-functions
- Other programmed addresses
- M-functions

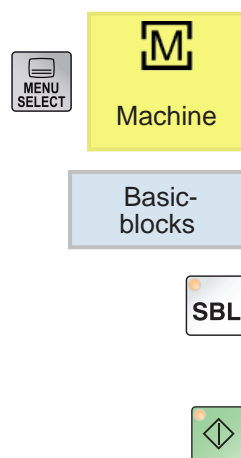

1 A program is opened.

2 Press softkey.

3 Press button for the program to be executed block-by-block.

4 Press button. The control system begins execution of the program.

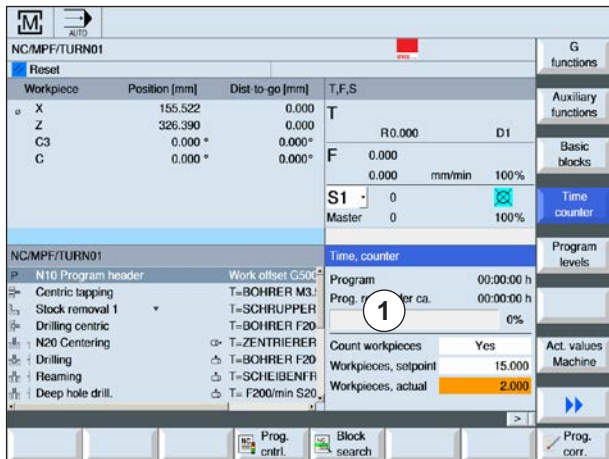

Show running time and workpieces

The program running time and the number of finished workpieces can be shown (1).

Show times

- Program**
 When the softkey is first pressed how long the program has been running will be shown. On each new program start the time required for the entire program run the first time it was run will be shown. If the program or the feed are changed, the new program running time will be corrected after the first run-through.
- Remaining program time**
 How long the current program still has to run will be shown. In addition the program progress display shows how close the current program run-through is to completion in per cent. The display appears for the first time during the second run-through of a program.
- Time measurement influence**
 Time measurement begins with the start of the program and ends when the program ends (M30). When the program is running time measurement is interrupted with NC-STOP and continued with NC-START. RESET followed by NC-START starts the time measurement from the beginning. NC-STOP or a Feed-override = 0 stops the time measurement.



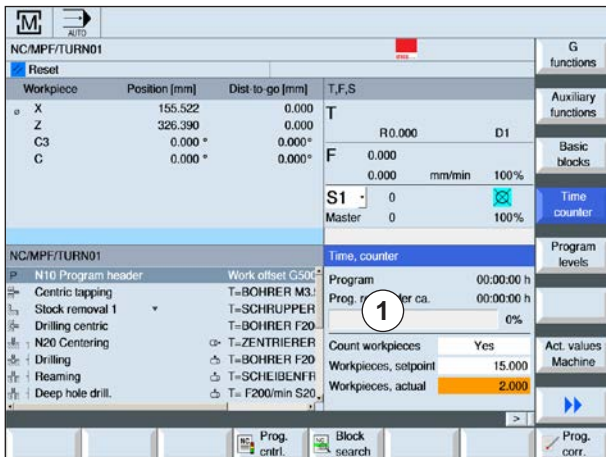

Count workpieces

Program repetitions or the number of finished workpieces can be shown. For the workpiece count, actual and target numbers are to be shown (1).

The counting of finished workpieces can be carried out via the program end (M30) or an M-command.

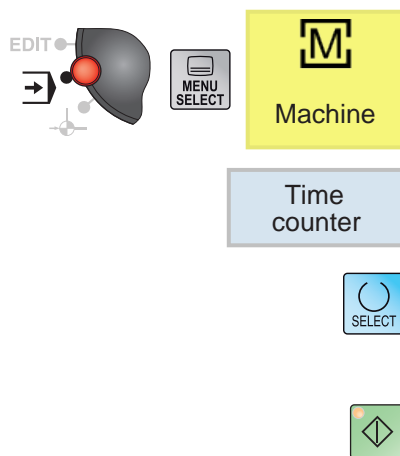

1 A program is selected.

2 Press softkey.

3 Press button to switch workpiece counting on or off.

4 Enter number of workpieces required.
Enter number of already finished workpieces.
After the defined number of workpieces is reached, the display of the current workpieces will be automatically set to zero.

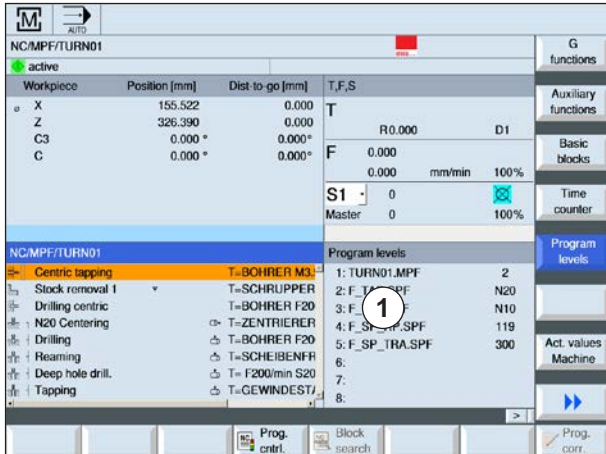

Show program levels

During processing of an extensive program with several sub-routine levels, which program level the processing is currently on can be shown (1).

Several program runs

If several program runs were programmed, i.e. sub-programs are executed several times in succession by input of the additional parameter P, during processing the program runs still to be executed will be shown.

Program example

N10 sub-program P25

If in a program plane at least one program still has to run through, a horizontal scrollbar appears to make it possible to see the run-counter P in the right part of the window. If there are no multiple runs pending, the scroll bar disappears.

The following information will be shown:

- Plane number
- Program name
- Block number or line number
- Remaining program runs (only for multiple program runs)

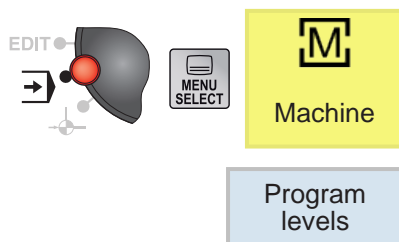

1 A program is selected.

2 Press softkey.

The following information will be shown:

- Plane number
- Program name
- Block number or line number
- Remaining program runs (only for multiple program runs)

MCS / WCS switch

The coordinates shown are relative either to the machine or the workpiece coordinate system. In contrast to the workpiece coordinate system (WCS), the machine coordinate system (MCS) does not take any zero point offsets into account. The softkey switches the display between machine coordinate system (MCS) and workpiece coordinate system (WCS).

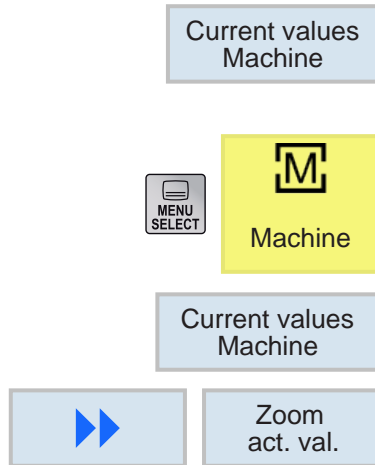

- 1 Open "Machine" operating area.
- 2 Use softkey to switch between MCS and WCS.
- 3 Press softkey. The screen window shows detailed displays:

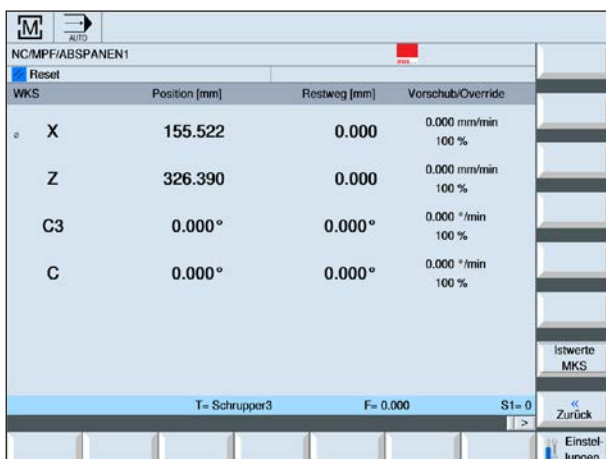

Display	Meaning
WCS / MCS	Display of the axes in the selected coordinate system.
Position	Position of the axes displayed.
Distance-to-go display	While the program is running the distance-to-go for the current NC block will be shown.
Feed/Override	In the full-screen version the effective feed on the axes as well as the Override will be shown.
Repos shift	The travel difference between the axes that has been brought about in manual mode is shown. This information will only be shown when you are in the sub-mode "Repos".
Footer	Display of the active zero point offsets and transformations. In the full-screen version, the T, F, S values will also be shown.

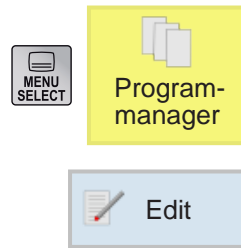

Editing program blocks

A NC program consists of several program blocks.

Program blocks can be edited as follows:

- Mark
- Copy
- Paste
- Cut
- Renumber
- Change cycles



Quit editing

1 Press softkey. The control system again shows the program management screen.

Search program block

1 A program is selected.

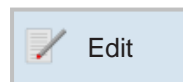

2 Press softkey.

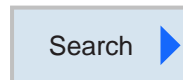

2 Press softkey.

3 Enter search term. Active control box when the search should be based on full words.



4 Select search direction with button.

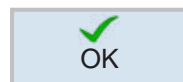

5 Press softkey to start search. If the text being searched for is found, the corresponding lines will be highlighted.

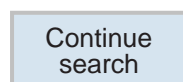

6a Using the softkey continue the search until the desired text is found at the desired location.



OR

6b Cancel search with softkey.

Search and replace program text

1 A program is selected.

2 Press softkey.

2 Press softkey.

3 Press softkey.

4 Enter search term. Active control box when the search should be based on full words.

5 Select search direction with button.

6 Enter replacement text. The search text will be replaced by the replacement text.

7 Press softkey to start search. If the text being searched for is found, the corresponding lines will be highlighted.

8a Press softkey to paste.

OR

8b Press softkey if all text in the files that corresponds to the search term should be replaced.

OR

8c Using the softkey, continue the search until the desired text is found at the desired location.

OR

8d Cancel search with softkey.

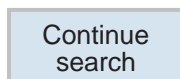
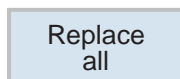
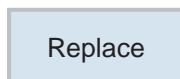
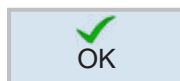
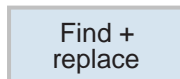
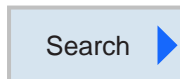
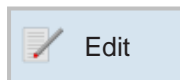

Instructions:

After texts within Shop-Turn/ShopMill, you cannot search for cycles. Neither can these be replaced.



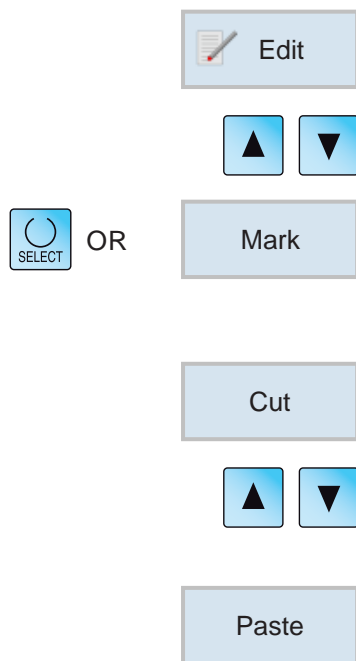

Move program block

- 1 Press softkey.
- 2 Position cursor on the cycle to be moved.
- 3 Press softkey. Cursor movement can be used to highlight several program lines at the same time.
- 4 Press softkey to cut.
- 5 Position cursor on the program block after which the cut program block should be pasted.
- 6 Press softkey to paste.

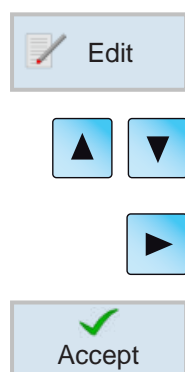

Change cycle

- 1 Press softkey.
- 2 Position cursor on the cycle to be changed.
- 3 Press button to open the cycle. Carry out changes.
- 4 Terminate change with softkey.

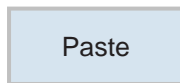
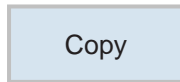
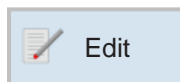

Copy program block

1 Press softkey.

2 Position cursor on the program block to be copied.

3 Press softkey to copy.

4 Position cursor on the program block after which the copied program block should be pasted.

5 Press softkey to paste.

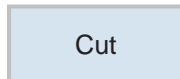
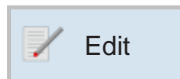

Delete program block

1 Press softkey.

2 Position cursor on the program block to be deleted.

3 Press softkey to cut. The program block will be deleted.

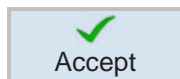
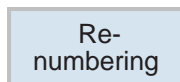
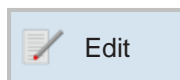

Renumber program block

1 Press softkey.

2 Press softkey. Enter first block number and the increment.

3 Terminate change with softkey.

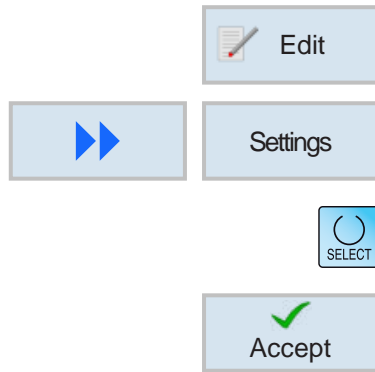

Define settings for program blocks

- 1 Press softkey.
- 2 Press softkey.
- 3 Select settings with button.
- 4 Terminate change with softkey.

Calculation operators in input fields

Mathematical calculations can be performed directly in the input field with the pocket calculator.

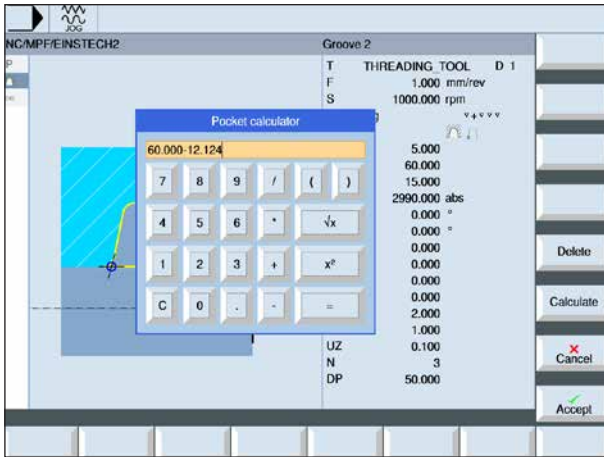

Call up pocket computer:
Press the "=" key in the input field

Inputs can be made both via the keyboard and via the keys on the pocket computer

Besides the functions on the pocket computer, the following softkeys are available:

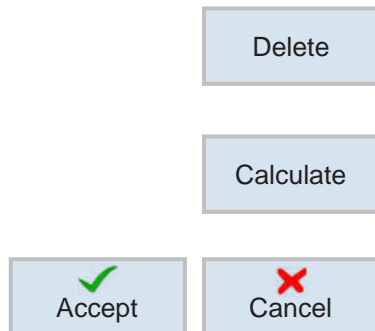

- Delete input
- Perform calculation
- Apply values or cancel calculation

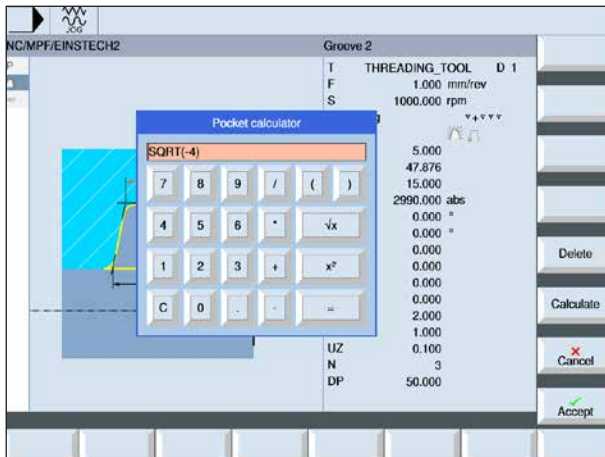

Unauthorized calculations are shown in red and not executed.

However, if the "Accept" softkey is pressed, the last valid value entered in the input field is kept.

COMMAND	MEANING
+, -, *, /, %, ^	Calculation functions
SIN()	Sine function
COS()	Cosine function
TAN()	Tangent function
ASIN()	Arc sine function
ACOS()	Arc cosine function
ATAN()	Arc tangent function (value)
ATAN2(,)	Inverse tangent function (X-section, Y-section)
SQRT()	Square root function
POT()	Power function
SQR()	2 power function
EXP()	Exponential function (base e)
LOG()	Logarithm function (base e)
LN()	Natural logarithmic function
PI	Circle division number (3.141592...)
TRUE	logically true (1)
FALSE	logically false (0)
ABS()	Absolute function
TRUNC()	Integer part function
ROUND()	Rounding function
MOD()	Modulo function

Backup fitting data

Tool data and zero point settings can be stored, as well as programs.

This option is useful for saving the required tools and zero point data for a particular work step program. If this program is processed again at a later date, then these settings can be retrieved quickly. Also, tool data that was computed using an external tool default setting device can be recorded in the tool management with ease.

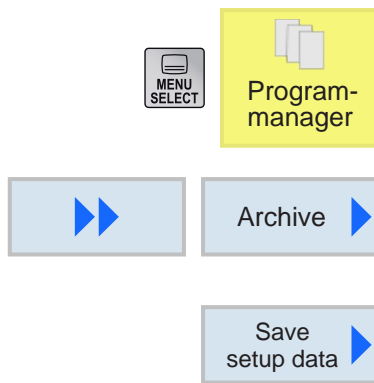
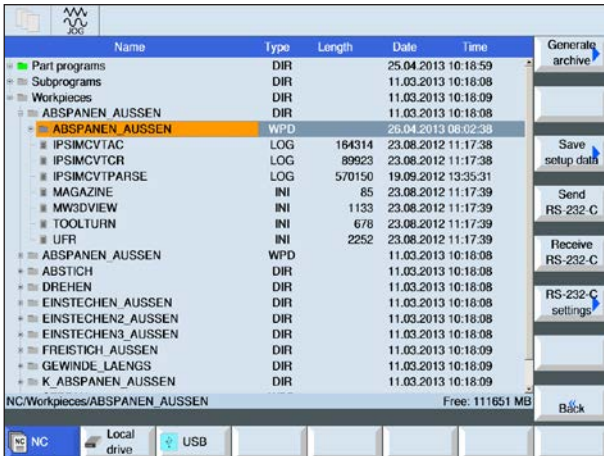

Backup fitting data

- 1 Select "Workpiece overview" in Program Manager
- 2 Position cursor on the workpiece for machining.
- 3 Press the Continue and Archive softkey.
- 4 Press Save fitting data softkey to open the Save fitting data window.

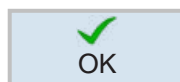
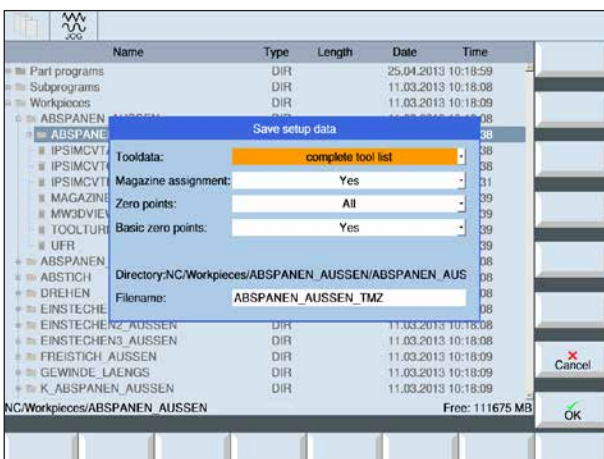

- 5 Confirm entry of the fitting data for saving with OK

Display	Setting options
Tool data	<ul style="list-style-type: none"> • complete tool list • no
Magazine assignment	<ul style="list-style-type: none"> • yes • no
Zero points	<ul style="list-style-type: none"> • all • no
Basic zero points	<ul style="list-style-type: none"> • yes • no
Directory	The directory in which the selected program is located is shown.
File name	You can change the proposed filenames.

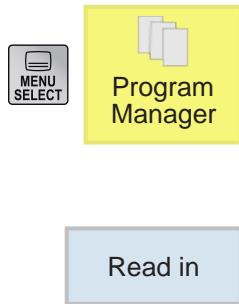

Read in fitting data

- 1 Select "Workpiece overview" in Program Manager
- 2 Position cursor on the .ini file for opening.
- 3 Press Read softkey.

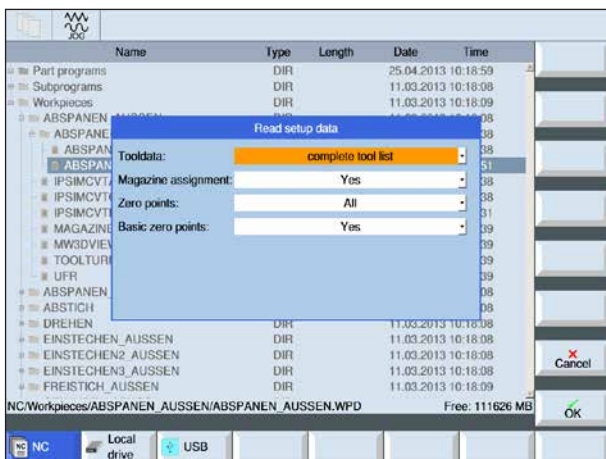

Instructions:
Depending on the choice of tool data and zero points when saving, this selected data is available again when reading in the fitting data.

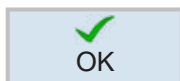

- 4 Confirm the fitting data that should be read in with OK

Instructions for the system of measurement:
When read in the backup fitting data please note that the control must be set to the system of measurement that was used when the data was saved. eg: the backup fitting data will only be read in and displayed in metric units when the controller was set to metric when saving.

Graphical simulation

Using the graphical simulation the current program is fully calculated and the result graphically displayed. This monitors the result of the programming without moving the machine axes. Wrongly programmed processing steps are recognized in a timely fashion, preventing the workpiece being mis-processed.

Only for G-code programming:

Raw part definition

The raw part dimensions enter in the program editor are used for the workpiece.

The raw part will be clamped relative to the coordinate system valid at the time of the raw part definition. Prior to the raw part definition in the G-code program the desired start conditions must be established, e.g. by selecting a suitable zero point offset.

Processing time

The The processing time is the approximate time the control system calculates for the duration of the tool movements executed with feed.

The processing time will be shown in the form (hh:mm:ss).

The time calculated by the control system lends itself only to a limited extent to the calculation of the production time, as the control system does not take account of machine-dependent times (e.g. for tool change).

Screen layout graphical simulation

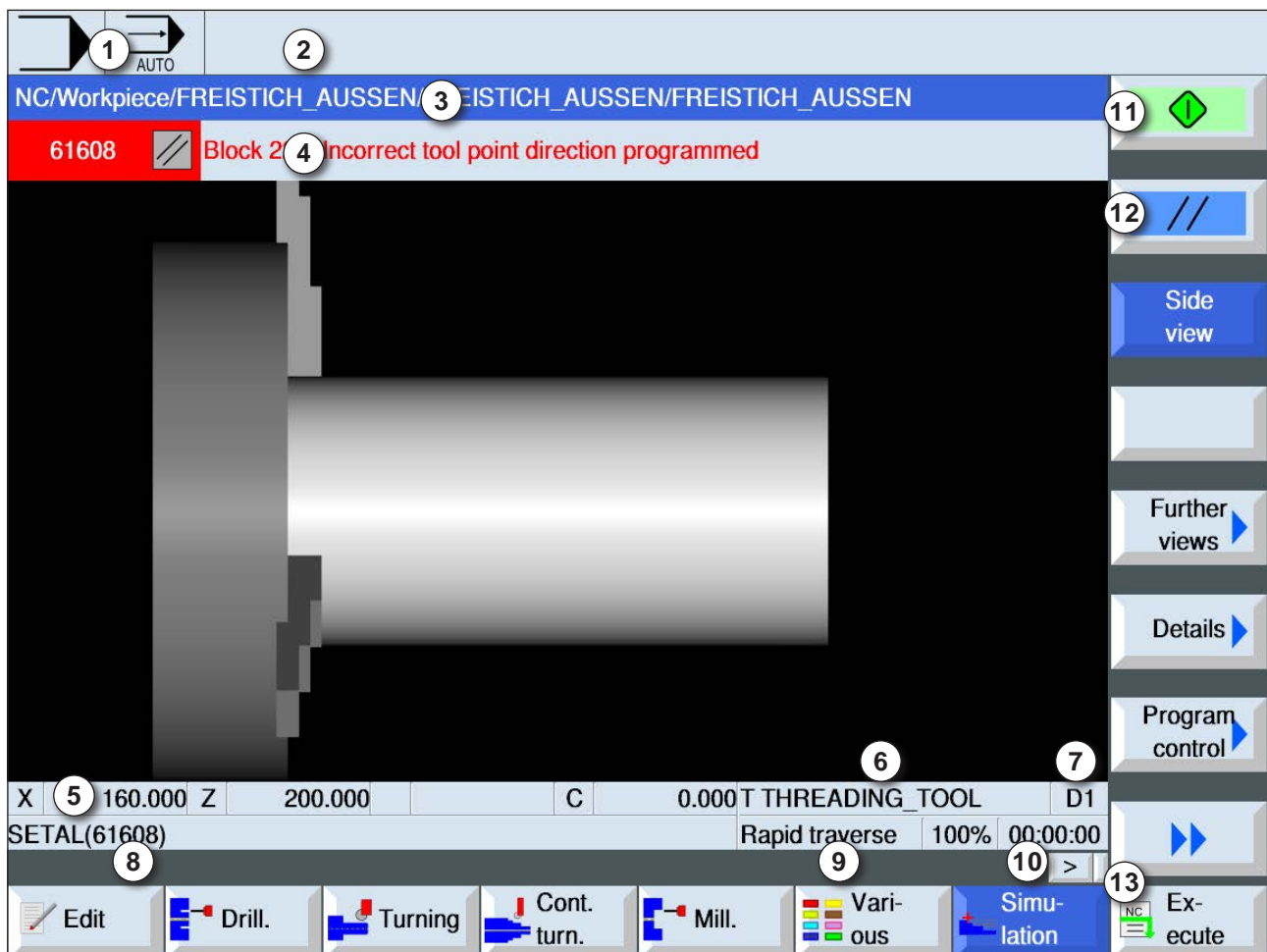

- | | |
|--------------------------------------------------|-----------------------------------------------------------------------------|
| 1 Active operating area and operating mode | 8 current NC program block |
| 2 Control system alarm and notification lines | 9 Display for rapid traverse or feed |
| 3 Program name | 10 Processing time |
| 4 Simulation system alarm and notification lines | 11 Press "Start" softkey to start or "Stop" softkey to stop the simulation. |
| 5 Axes positional display | 12 Press "Reset" softkey to reset the simulation. |
| 6 Tool name | 13 Horizontal and vertical softkey bars |
| 7 Cutting number | |

softkey functions



Start simulation

This softkey starts the simulation. For the simulation to be started, an NC program must be selected. The program name of the currently selected NC program will be shown in the top left in the simulation window.



Stop simulation

This softkey stops the simulation and the NC program. The simulation can be continued with "Start".



Cancel simulation

This softkey cancels the simulation and the NC program. The simulation can be started again with "Start".

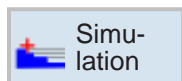
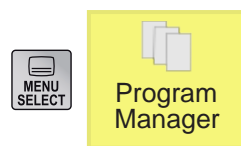

Simulating workpiece processing

1 Position cursor on directory in which the program should be selected.

2 Press button.

3 Press softkey to simulate.

4 Press softkey to start simulation. The program processing will be shown graphically on the screen. In the process, the machine axes do not move.

5a Press softkey to stop simulation.

OR

5b Press softkey to cancel simulation.

6 Press softkey to continue simulation or to start again after canceling.



7 Continue to raw part setting is available only with G-code programming



Select workpiece view

Side view

1 Press softkey to show the workpiece in side view.

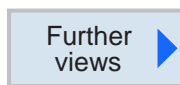

Other views

1 Press softkey to open the selection for other views.



- The workpiece is shown in the exploded state.

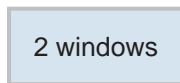

- In the 2-window view, you have a side view (left window) and a front view (right window) of the workpiece. Here, the direction of viewing is always on to the cutting surface from the front, even if it was machined from behind or from the back.

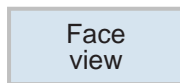

- The front view shows the workpiece in the X-Y plane.



3D view configuration

Press softkeys to start 3D view configuration

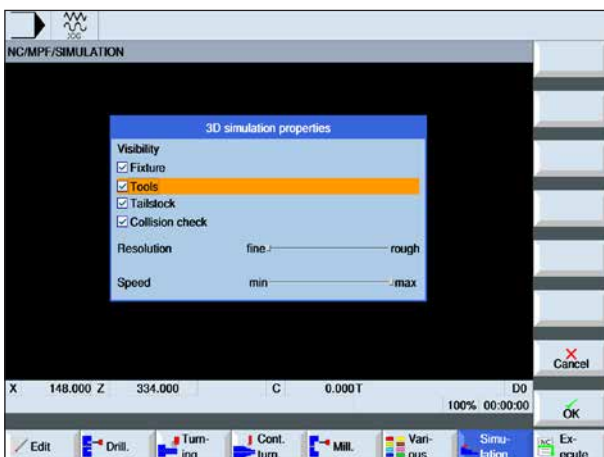

Instructions:

The choice of setting options available depends on whether a 3D view license is present or not.

Details 

Zoom +

Zoom -

Autozoom

Zoom graphics

The zoom commands enable the simulation image to be made larger or smaller. It can be moved with the cursor keys.

Larger

After pressing the softkey the view will be increased by one level in size.

Smaller

After pressing the softkey the view will be reduced by one level in size.

Automatic

Increases or reduces the display area to the window size.

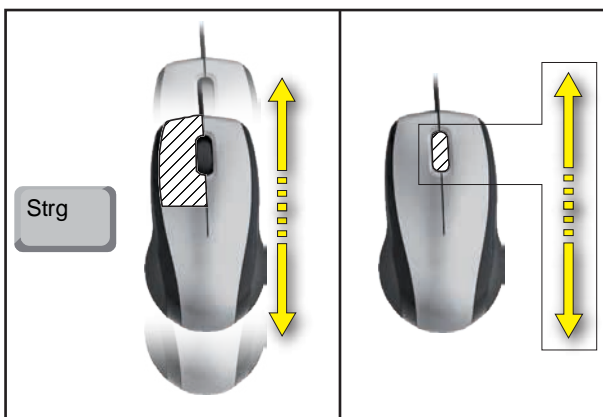

Zoom with the mouse

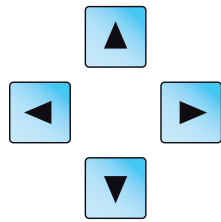

Shift graphics

Press cursor button to shift the graphics.

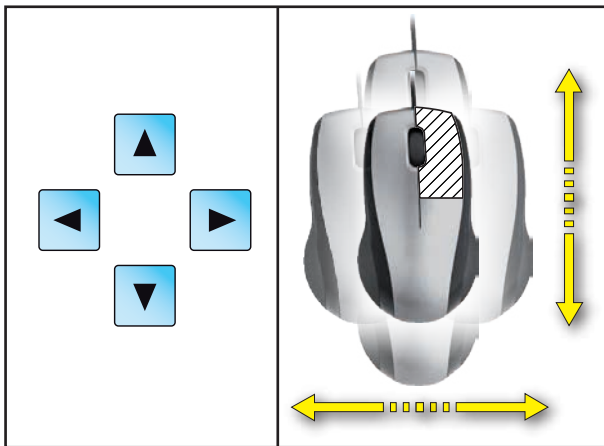

Shift



Use the softkeys to adapt the representation area quickly again to the window size.

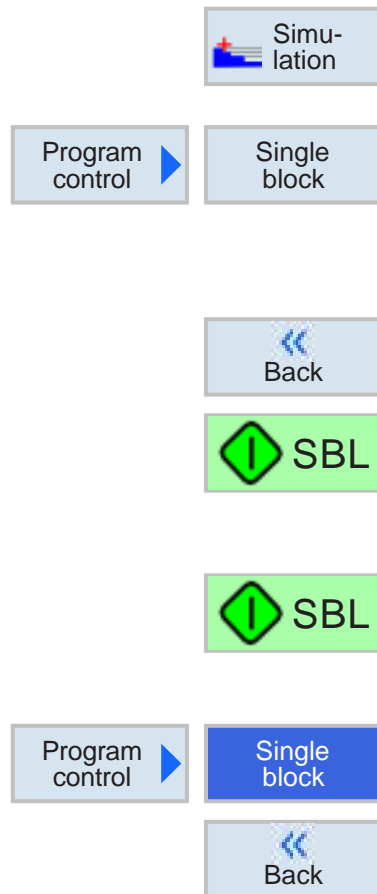

Block-by-block simulation

Analogously to the program execution in single block mode (SBL) the simulation can also be simulated block for block.

1 The NC program is selected in simulation mode.

Activate block-by-block simulation

2 Press softkey to start simulation. The program processing will be shown graphically on the screen. In the process, the machine axes do not move.

3 Press softkey.

4 Press softkey to start simulation in single block mode (SBL). The next program block will be simulated. Afterwards the simulation will stop.

5 Press softkey again to simulate the next program block.

Deactivate block-by-block simulation

6 Press softkey to deactivate single block mode.

7 Press softkey.

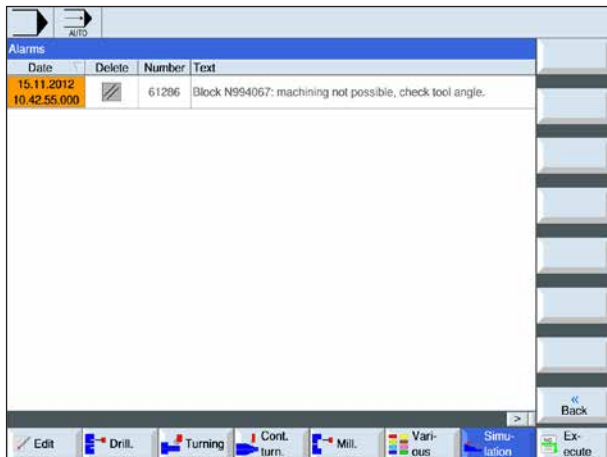

Simulation alarm

If alarms or messages occur during the simulation, they will be shown in the alarm and message lines in the simulation window.

- 1 Press softkey to open alarm overview.
The alarm overview contains the following information:
 - Date and time
 - Deletion criteria indicate the softkey the alarm can be acknowledged with
 - Alarm number
 - Alarm text



Quit graphical simulation

- 1 Press softkey. The control system switches to the program view of the NC program previously selected for the simulation.

- 2 Press button to go to program management.

Diagnostics operating area

In the diagnostics operating area alarms, messages and version data can be shown.





Show alarm list

This softkey shows the alarm list.

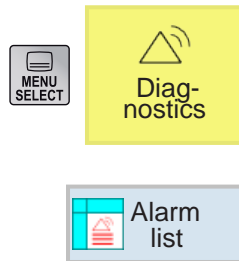
All pending alarms can be shown and acknowledged. The alarm overview contains the following information:

- Date and time
- Deletion criteria indicate the button or softkey the alarm can be acknowledged with
- Alarm number
- Alarm text



Symbol	Meaning
	Switch machine off at the main switch and then on again.
	Press reset button. 
	Press the button to acknowledge alarms. 
PLC	Press reset button and, if applicable, also remove the machine's error condition.

Show messages

This softkey shows the messages. Messages do not interrupt the processing. Messages give information about the specific behavior of the cycles and on the processing progress.

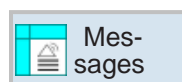

Version data

This softkey shows the version numbers of the installed software products.

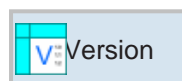

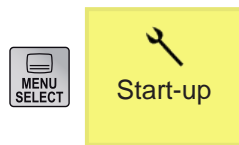

Commissioning operating area

In the commissioning operating area the license data for EMCO software products can be shown.



Close Sinumerik Operate

1 Switch off auxiliary drives with AUX OFF.

2 By simultaneously pressing these buttons WinNC for Sinumerik Operate will be deliberately closed.

This corresponds to Alt+F4 on the PC keyboard.

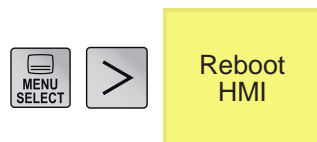

Restart Sinumerik Operate

This softkey deliberately restarts WinNC for Sinumerik Operate.

D: ShopTurn programming

Overviews

M-Commands

M 00	Programmed stop
M 01	Optional stop
M 02	End of program
M 2=3	Spindle ON clockwise
M 2=4	Spindle ON counterclockwise
M 2=5	Spindle OFF
M 07	Minimal lubrication ON
M 08	Coolant ON
M 09	Coolant OFF, minimal lubrication OFF
M 17	Sub-routine END
M 20	Quill BACK
M 21	Quill ADVANCE
M 25	OPEN clamping device
M 26	CLOSE clamping device
M 30	End main program
M 71	Purge ON
M 72	Purge OFF
M 90	Manual chuck
M 91	Automatic chuck
M 92	Pressure clamping device

Create ShopTurn program

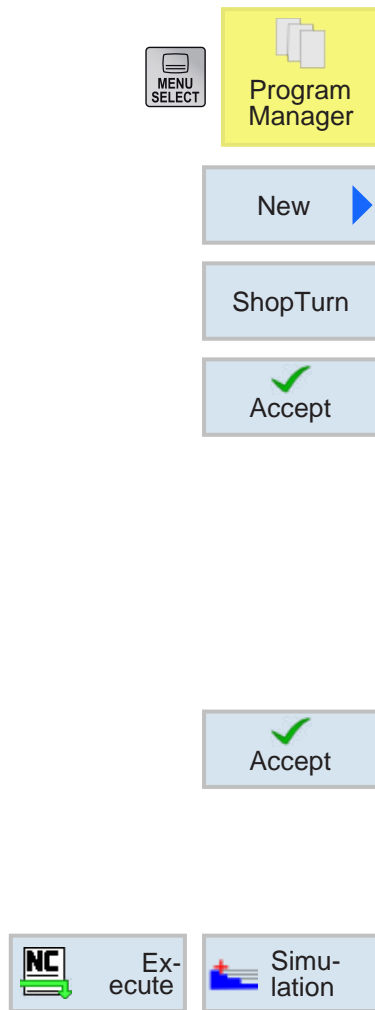

1 Select "Program manager".

2 Press softkey.

3 Selection that a ShopTurn program should be produced.

4 Enter program name and confirm with softkey. If the program name already exists the softkey remains deactivated.

5 Then fill out program header. Select zero point offsets, enter raw part measurements and parameters. These inputs (e.g.: measurement unit mm or inch, retraction plane, safety distance and processing direction of rotation) apply across the entire program.

6 Press softkey to apply the program head in the workpiece program. Program header and program end will be created in the block list. The program end is defined automatically.

7 Enter additional cycles.

8 Select or simulate cycles via softkeys.

9 Finally define the program end. The program end signals to the machine that the processing of the workpiece is finished.

Program header

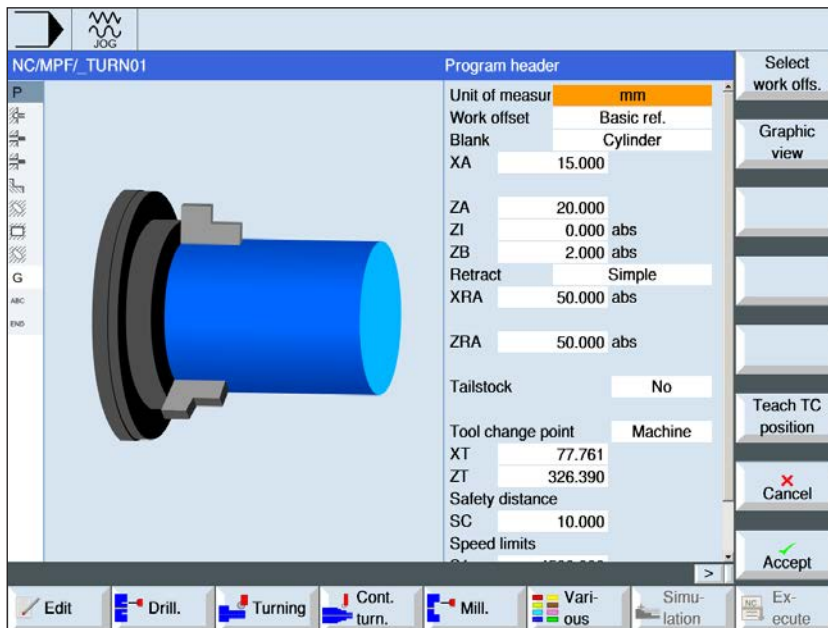

The "Select" button gives you the option to change parameters and/or units. To do this move the cursor to the appropriate field and press button.

Parameter	Description	Unit
Measurement unit	Setting the measurement unit (mm or inch) in the program header relates only to the position details in the current program.	mm inch
Zero point shift	Zero point offset in which the zero point of the workpiece is saved.	
Raw part	<ul style="list-style-type: none"> • Cuboid center • Tube • Cylinder • Polygon 	
XA	External diameter \varnothing (only if tube or cylinder)	mm
N	Number of edges (only with polygon)	
SW L	Key width (only if N is an integer) Edge length	
W	Width of the raw part (only with cuboid center)	mm
L	Length of the raw part (only with cuboid center)	mm
XI	Internal diameter \varnothing (absolute) or wall thickness (incrementally) (only if tube)	mm
ZA	Start measurement	mm
ZI	End dimension depth (absolute) or end dimension relative to ZA (incrementally).	mm
ZB	Machining dimension depth (absolute) or machining dimension relative to ZA (incrementally)	

Parameter	Description	Unit
Retract	The retraction area marks the area outside which it must be possible for the axes to move without risk of collision. <ul style="list-style-type: none"> • single • extended • all 	
XRO	Retraction plane X outside \emptyset (absolute) or retraction plane X relative to XO (incrementally)	
XRI	Retraction plane X inside \emptyset (absolute) or retraction plane X relative to XI (incrementally) (only if tube)	
ZRO	Retraction plane Z in front (absolute) or retraction plane Z relative to ZO (incrementally)	
ZRI	Retraction plane Z behind	
Tailstock	<ul style="list-style-type: none"> • yes • no 	
XRR	Retraction plane tailstock \emptyset (only tailstock yes)	
Tool change point	<ul style="list-style-type: none"> • TCS (Tool coordinates system) • MCS (Machine coordinate system) Instructions: <ul style="list-style-type: none"> • The tool change point must be far enough outside the retraction area that, when the revolver tilts, no tool is protruding into the retraction area. • Note that the tool change point refers to the zero point of the revolver and not to the tooltip. 	
XT ZT	Tool change point X \emptyset Tool change point Z	
Tool chg. pt teach	Teach tool change point is only active for MCS. Selecting the softkey applies the current machine coordinates for the tool change point	
SC	The safety distance defines how close to to the workpiece the tool can move in rapid traverse. Instructions: Enter the safety distance without symbol in incremental dimension.	
S1	Spindle speed (maximum main spindle speed) If you want to machine the workpiece at constant cutting speed, the spindle speed must be increased as soon as the workpiece diameter reduces. Because the speed cannot be increased at random, you can decide a speed limit for the main spindle (S1) dependent on the shape, size and material of the workpiece or chuck.	rpm
Processing direction of rotation	<ul style="list-style-type: none"> • Up-cut • Downcut 	

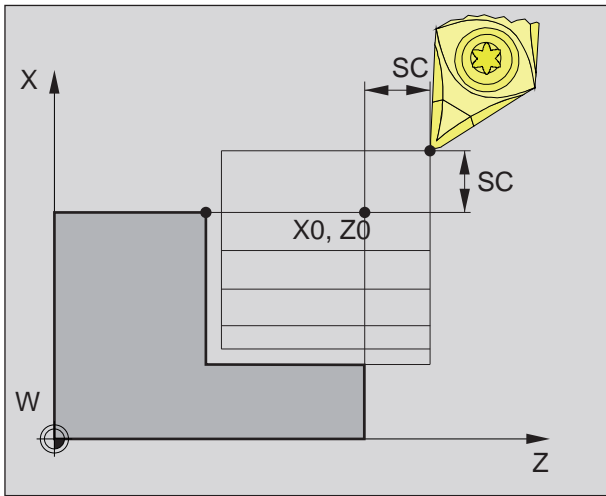

Safety distance SC

Safety distance

To avoid collisions with the workpiece during cycles, an approach point can be defined that is approached prior to the cycle start point.

The safety distance SC gives the position of this approach point relative to the cycle start point.
X0 and Z0: Machining start point

End of program

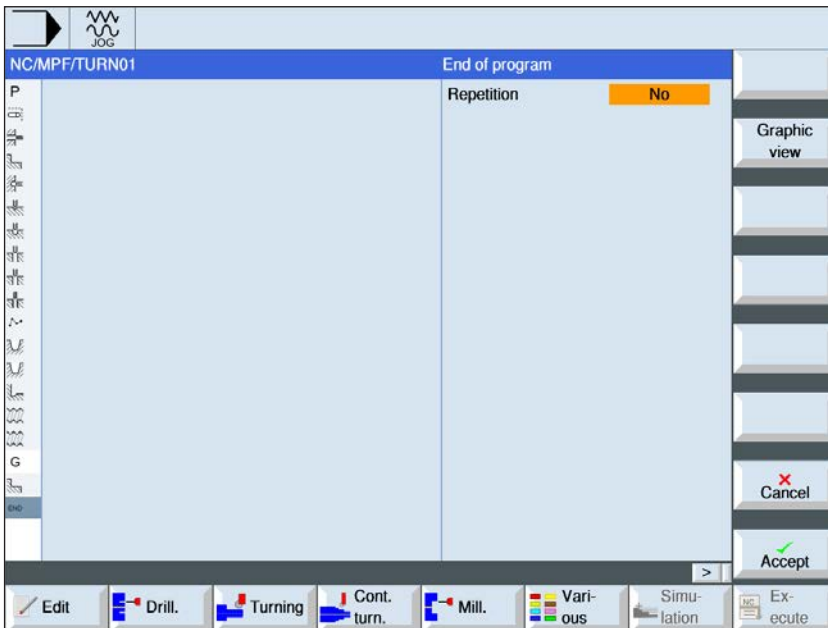

The "Select" button gives you the option to change parameters and/or units. To do this move the cursor to the appropriate field and press button.

Parameter	Description	Unit
Repetition	<ul style="list-style-type: none"> • yes The program execution will be repeated. • no The program execution will not be repeated. 	

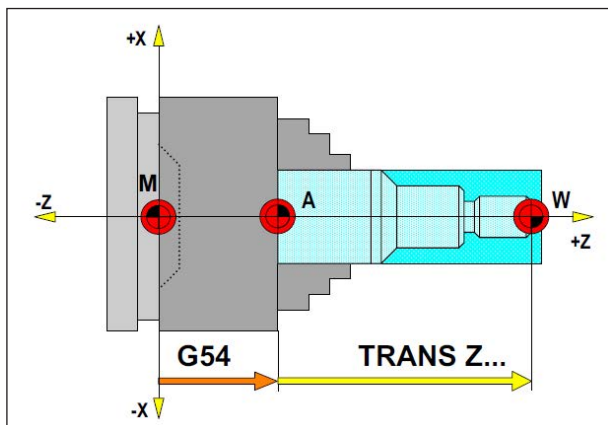

In the following situation the raw part must be described from the stop point A

Raw part definition

When a program with a stop point (e.g. G54) and a transformation (TRANS / ATRANS) is used to machine to the actual workpiece zero point, the raw part definition must be described from the stop point.

M= Machine zero point

A= Stop point

W= Workpiece zero point

Cycle overview

The cycle groups with the Sinumerik Operate cycles defined within them are listed here.



Drilling

- Drilling centrally
- Thread drilling centrally
- Centering
- Drilling
- Abrading
- Long-hole drilling
- Thread
- Positions



Turn

- Machining
- Grooving
- Thread undercut
- Thread
- Grooving

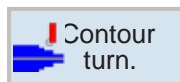

Contour turning

- New contour
- Machining
- Grooving
- Groove turning



Milling

- Pocket
- Spigot
- Multiple edge
- Slot
- Thread milling
- Engraving



Contour milling

- New contour
- Path milling
- Pre-drilling
- Pocket
- Spigot

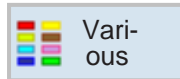

Various

- Settings
- Transformations
- Sub-routine
- Repeat program
- Bar loading interface

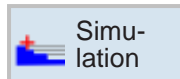

Simulation

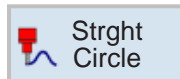

Straight line or circular machining

- Delete
- Straight line
- Circle center
- Circle radius
- Polar

Working with cycles

Processes that repeat often, and which include several processing steps, are saved in the control system as cycles. Some special functions are also available as cycles.

Define cycle

The softkey bar shows the different cycle groups.

- Select cycle group
- Select cycle
- Enter all required parameters

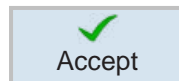
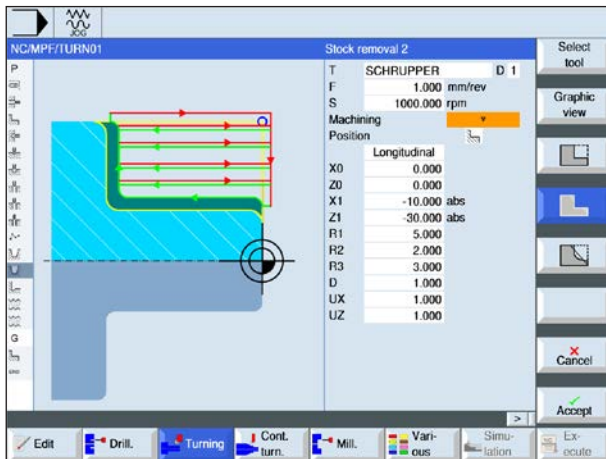

- Terminate input with this softkey.

Geometry and technology data input

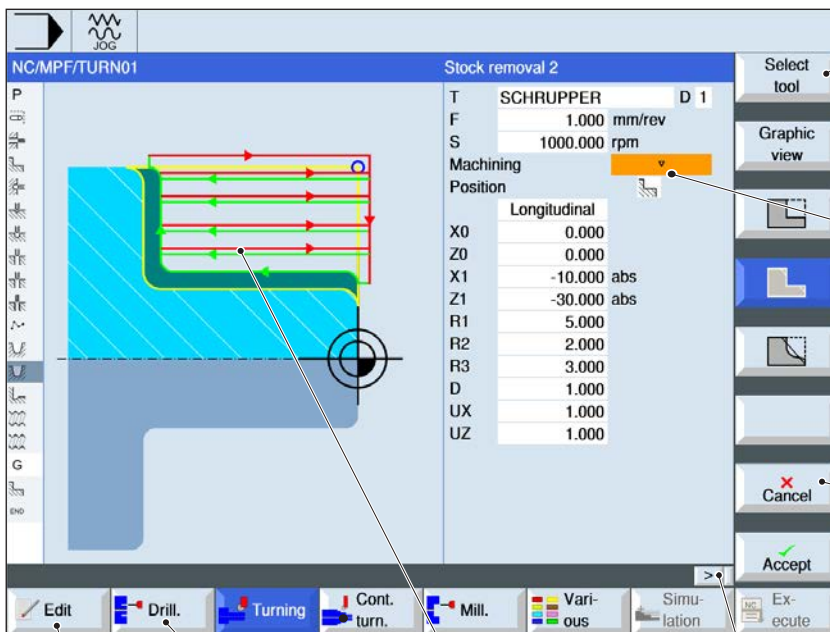

softkey for tool programming



Selection fields: Using the "Select" button parameters and/or units can optionally be changed. To do this move the cursor to the appropriate field and press button.

softkeys for additional functions



The horizontal softkey bar is extended with this button.

Coloured positioning movements:

- Red positioning movement = tool moves in rapid traverse.
- Green positioning movement = tool moves in machining feed.

This softkey is used, for example to "Copy", "Paste" and "Delete" cycles.

These softkeys show the cycle groups that are additionally available.

Default values for cycle parameters

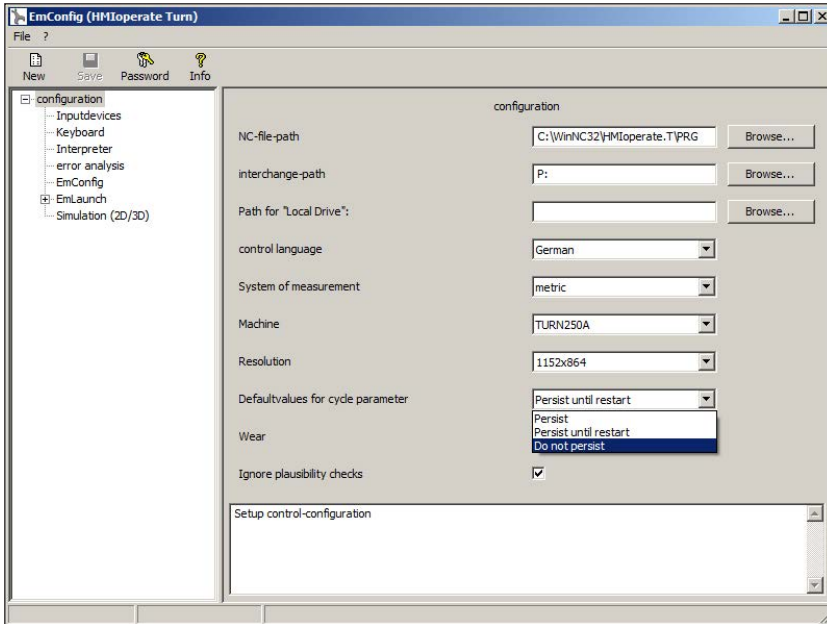

EMConfig is an auxiliary software to WinNC. WinNC settings can be changed with EMConfig.

Open EMConfig and select the configuration point:

Default values for cycle parameters

Instructions:

If cycles have already been programmed once, then these input values are saved and next time are proposed as default values. This can be unfavourable in training and can therefore be configured via EMConfig.



The following settings can be reached under the default values heading:

- always maintained**
 last entered cycle data remains even after receiving a control system restart
- replace for restart**
 last entered cycle data remains received while the control system is still running
- never maintained**
 Cycle data is reset to the default values immediately after quitting the cycle

Ignore plausibility check for saving

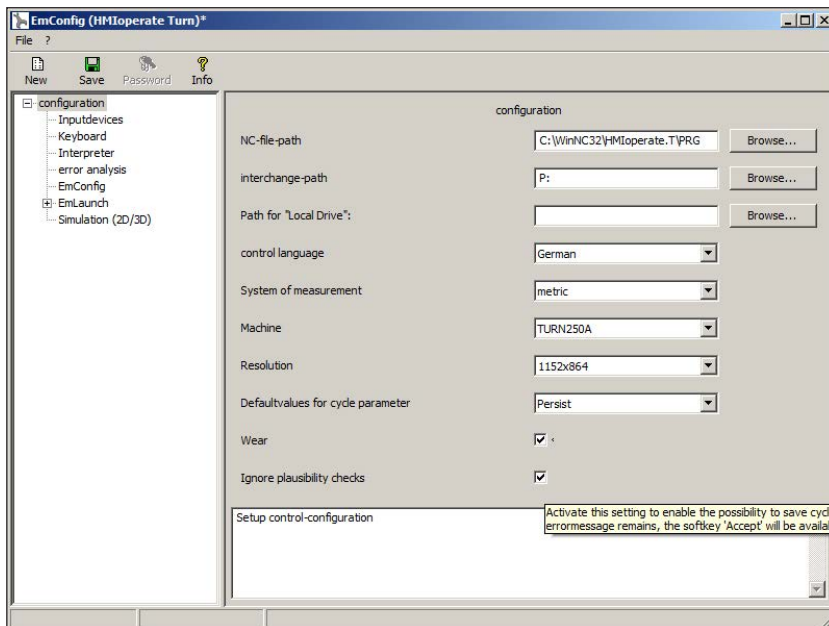

Use this checkbox to activate or deactivate the plausibility check for saving.

Activate this setting to be able to save cycles, despite an error message being present. The corresponding error messages certainly remain in existence, but the "Accept" softkey is available.

Set plausibility check for saving

Set length tool wear

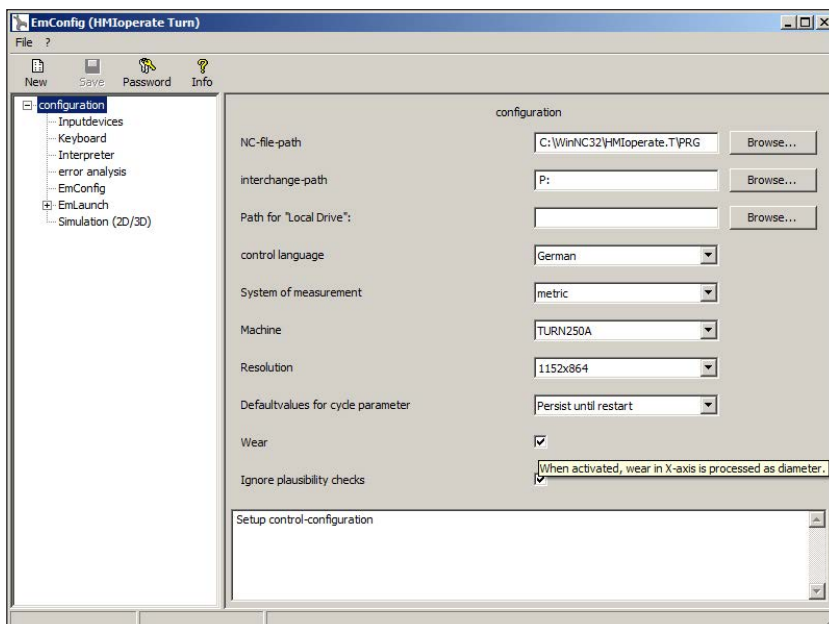

Use this checkbox to state tool wear length for rotating tools as diameter or as length.

Set wear as diameter or length

Instructions:

This setting is only valid for turning tools.



Set system of measurement

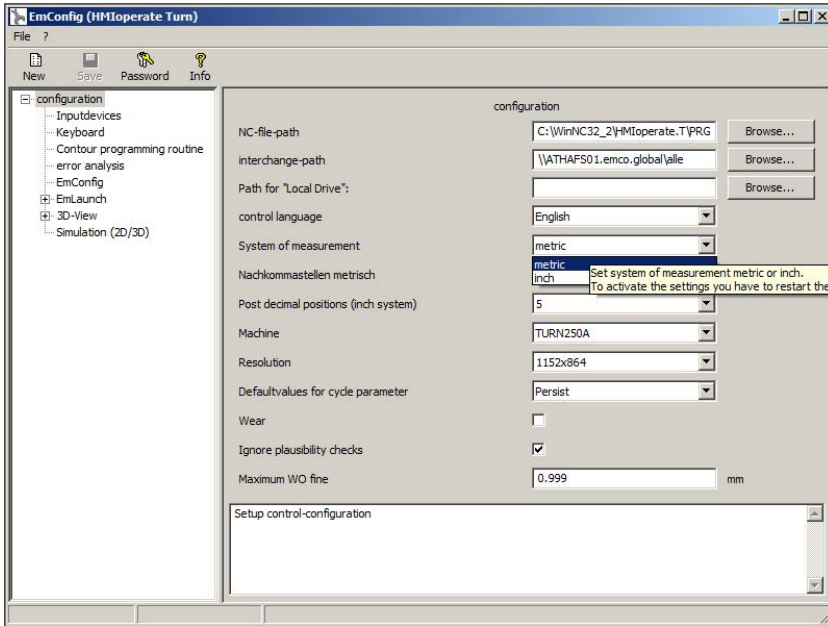

With this checkbox the system of measurement for the control software can be set to metric or inch.

Set the system of measurement to metric or inch

Note: Inch programs can not be used with metric control (and vice versa).

Table of units

inch			
feet ^{*)}	inch	mm	m
1	12	304,5	0,304
inch ^{°)}	feet	mm	m
1	0,83	25,4	0,0254

metric			
m	mm	inch	feet
1	1000	39,37008	3,28084
mm	m	inch	feet
1	0,001	0,0393701	0,0032808

^{*)} **feet:** only for constant cutting speed
^{°)} **inch:** standard input



Drilling

- Drilling centrally
- Thread drilling centrally
- Centering
- Drilling
- Abrading
- Long-hole drilling
- Thread
- Positions

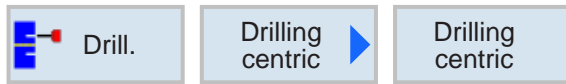

Drilling centrally

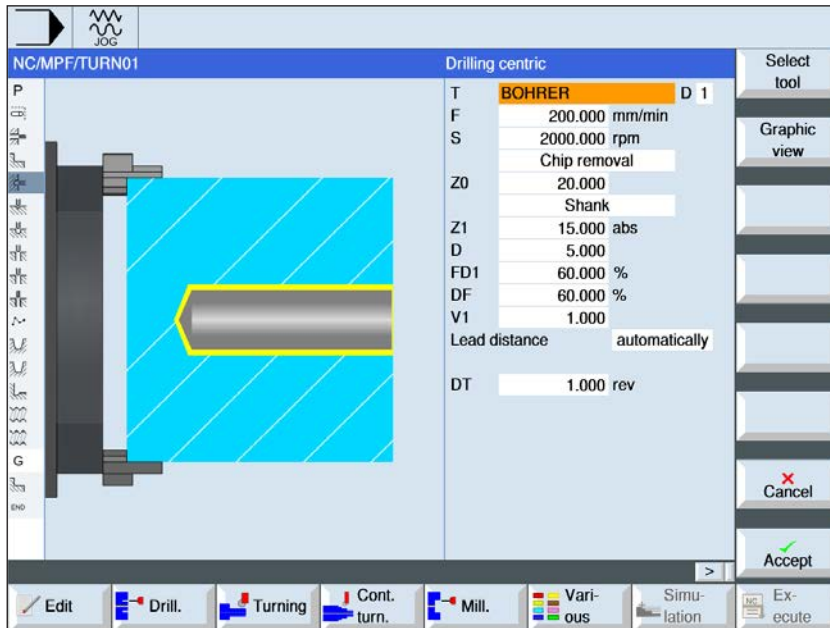

The "Select" button gives you the option to change parameters and/or units. To do this move the cursor to the appropriate field and press button.

Parameter	Description	Unit
T	Tool name	
D	Cutting number	
F	Feed	mm/min mm/rev
S / V	Spindle speed or constant cutting speed	rpm m/min
Machining	<ul style="list-style-type: none"> • Chip crushing • Chip clearing 	
Z0	Reference point Z	mm
Drill depth	<ul style="list-style-type: none"> • Shaft (drilling depth relative to the shaft). The drill plunges until the drill shaft reaches the programmed value Z1. • Tip (drill depth relative to the tip) The drill plunges until the drill tip reaches the programmed value Z1. 	mm
Z1 X1	Drill depth (absolute) or depth relative to Z0 (incremental). The tool penetrates until Z1 or X1 is reached.	mm
D	maximum depth infeed	mm
FD1	Percentage rate for the feed during the first infeed	%
DF	<ul style="list-style-type: none"> • Percentage rate for each additional infeed or • amount for each additional infeed DF = 100: Infeed amount remains the same DF < 100: Infeed amount is reduced in the end drilling depth direction Example: DF = 80 last infeed was 4 mm; 4 x 80% = 3.2; next infeed amount becomes 3.2 mm 3.2 x 80% = 2.56; next infeed amount becomes 2.56 mm etc.	% mm

Parameter	Description	Unit
V1	minimal infeed depth Parameter V1 is only present if DF<100% was programmed. A minimum infeed is programmed with the parameter V1.	mm
V2	Retract amount after each machining (only for "Chip crushing" machining)	mm
V3	Advanced stop distance - (only for advanced stop distance "manually")	mm
Advance stop distance	- (only for "Chip clearing" machining) • manually • automatic	mm
DT	• Dwell time on the ground in seconds • Dwell time on the ground in revolutions	s U

Cycle description

- 1 The control system positions the tool in the spindle axis in rapid traverse (G0) to the safety distance above the reference point.
- 2 The tool centers with the programmed feed (F) till the depth (Z1) is reached and dwells there (DT) - if indicated.
- 3 From the drill bottom the tool moves back to the retraction plane in rapid traverse after expiry of the dwell time (DT).

Cycle description

Chip crushing

- 1 The tool drills with the programmed speed (S) or cutting speed (V) to the 1st infeed depth (maximum depth infeed D).
- 2 Spindle stop.
- 3 The tool moves back by the retraction amount (V2) for chip crushing.
- 4 The tool drills with a spindle speed (S) or cutting speed (V) to the next infeed depth, which can be reduced by the factor DF.
- 5 Repeat steps 3 to 4 until the programmed end drilling depth (Z1) is reached.
- 7 The tool moves back to the safety distance in rapid traverse.

Cycle description

Chip clearing

- 1 The tool drills with the programmed speed (S) or cutting speed (V) to the 1st infeed depth (maximum depth infeed D).
- 2 Spindle stop.
- 3 The tool moves out for chip clearing in rapid traverse (G0) to the safety distance from the workpiece and penetrates again to the 1st infeed depth, reduced by an advance stop distance computed by the control system.
- 4 Spindle stop.
- 5 The drill then bores to the next infeed depth, which in this case can be reduced by the factor DF, and the tool retracts again for chip clearance at Z0 + safety distance.
- 6 Step 5 is repeated until the end drilling depth Z1 is reached and the dwell time DT has expired.
- 7 The tool moves back to the safety distance in rapid traverse.

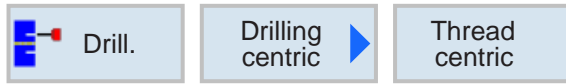

Thread drilling centrally

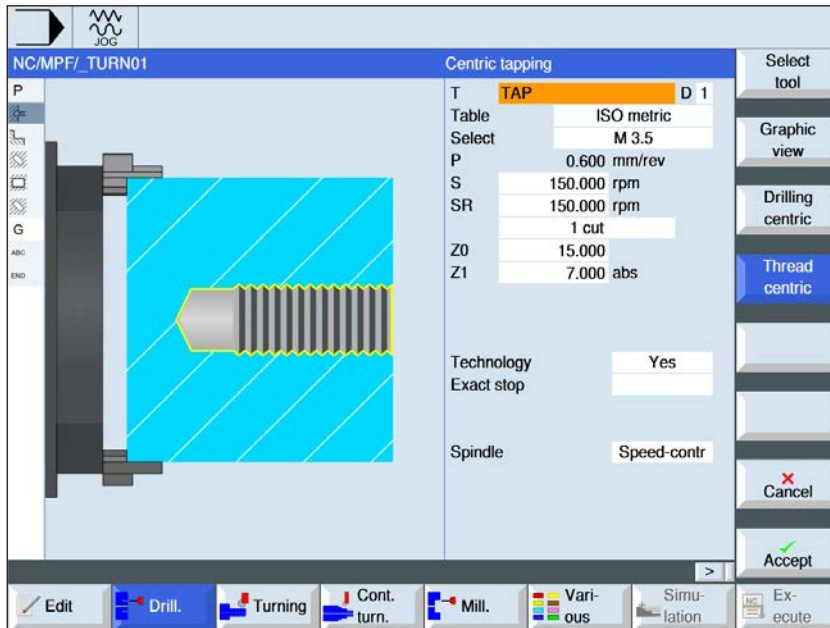

The "Select" button gives you the option to change parameters and/or units. To do this move the cursor to the appropriate field and press button.

Parameter	Description	Unit
T	Tool name	
D	Cutting number	
Table	Thread selection table: <ul style="list-style-type: none"> • none • ISO metric • Whitworth BSW • Whitworth BSP • UNC 	
Selection	Selection of the table value e.g.: <ul style="list-style-type: none"> • M1; M5; etc. (ISO metric) • W1/8"; etc. (Whitworth BSW) • G 1 3/4"; etc. (Whitworth BSP) • N8 - 32 UNC; etc. (UNC) (also see thread table with respective pitches)	
P	Display of the thread lead (only with table selection "none") <ul style="list-style-type: none"> • in MODULE: $MODULE = \text{pitch} / \pi$ • in threads per inch: as is typical with pipe threads. With the per inch input, in the first parameter field the whole number before the decimal point is entered and in the second and third field the number after the decimal point is entered as a fraction. <ul style="list-style-type: none"> • in mm/rev • in inches/rev The thread lead is dependent on the tool used.	MODULE Threads/" mm/rev inches/rev

Parameter	Description	Unit
S / V	Spindle speed or constant cutting speed	rpm m/min
SR	Spindle speed for retraction	rpm
VR	constant cutting speed for retraction	m/min
Machining	<ul style="list-style-type: none"> • 1 cut The thread will be drilled in one cut, without interruption. • Chip crushing The drill withdraws by the retraction amount V2 to break up the chips. • Chip clearing The drill moves completely out of the workpiece for chip clearing. 	
Z0	Reference point in Z	mm
Z1	End point of the thread (absolute) or thread length (incremental).	mm
D	maximum depth infeed	mm
Retract	Retraction amount (only if "Chip breaking" selected) <ul style="list-style-type: none"> • manually With retract amount (V2) after each processing. • automatic Without retract amount (V2) after each processing. The tool will be pulled back by one revolution after each processing. 	
V2	Retract amount after each processing Amount by which the tool will be pulled back during chip crushing	mm
Technology	<ul style="list-style-type: none"> • yes • no 	
Precision stop	<ul style="list-style-type: none"> • Behavior as it was before the cycle call-up • G601: Block advance for fine precision stop • G602: Block advance for crude precision stop Only for "Yes" technology	
Spindle	<ul style="list-style-type: none"> • governed: • position-controlled: Only for "Yes" technology	

Thread table

ISO_METRIC		WHITWORTH_BSW		WHITWORTH_BSP		UNC	
M 1	0.250	W 1/16"	60.000	G 1/16"	28.000	N 1 - 64 UNC	64.000
M 1.2	0.250	W 3/32"	48.000	G 1/8"	28.000	N 2 - 56 UNC	56.000
M 1.6	0.350	W 1/8"	40.000	G 1/4"	19.000	N 3 - 48 UNC	48.000
M 2	0.400	W 5/32"	32.000	G 3/8"	19.000	N 4 - 40 UNC	40.000
M 2.5	0.450	W 3/16"	24.000	G 1/2"	14.000	N 5 - 40 UNC	40.000
M 3	0.500	W 7/32"	24.000	G 5/8"	14.000	N 6 - 32 UNC	32.000
M 3.5	0.600	W 1/4"	20.000	G 3/4"	14.000	N 8 - 32 UNC	32.000
M 4	0.700	W 5/16"	18.000	G 7/8"	14.000	N 10 - 24 UNC	24.000
M 4.5	0.750	W 3/8"	16.000	G 1"	11.000	N 12 - 24 UNC	24.000
M 5	0.800	W 7/16"	14.000	G 1 1/8"	11.000	1/4" - 20 UNC	20.000
M 6	1.000	W 1/2"	12.000	G 1 1/4"	11.000	5/16" - 18 UNC	18.000
M 8	1.250	W 9/16"	12.000	G 1 3/8"	11.000	3/8" - 16 UNC	16.000
M 10	1.500	W 5/8"	11.000	G 1 1/2"	11.000	7/16" - 14 UNC	14.000
M 12	1.750	W 3/4"	10.000	G 1 3/4"	11.000	1/2" - 13 UNC	13.000
M 14	2.000	W 7/8"	9.000	G 2"	11.000	9/16" - 12 UNC	12.000
M 16	2.000	W 1"	8.000	G 2 1/4"	11.000	5/8" - 11 UNC	11.000
M 18	2.500	W 1 1/8"	7.000	G 2 1/2"	11.000	3/4" - 10 UNC	10.000
M 20	2.500	W 1 1/4"	7.000	G 2 3/4"	11.000	7/8" - 9 UNC	9.000
M 22	2.500	W 1 3/8"	6.000	G 3"	11.000	1" - 8 UNC	8.000
M 24	3.000	W 1 1/2"	6.000	G 3 1/4"	11.000	1 1/8" - 7 UNC	7.000
M 27	3.000	W 1 5/8"	5.000	G 3 1/2"	11.000	1 1/4" - 7 UNC	7.000
M 30	3.500	W 1 3/4"	5.000	G 3 3/4"	11.000	1 3/8" - 6 UNC	6.000
M 33	3.500	W 1 7/8"	4.500	G 4"	11.000	1 1/2" - 6 UNC	6.000
M 36	4.000	W 2"	4.500	G 5"	11.000	1 3/4" - 5 UNC	5.000
M 39	4.000	W 2 1/4"	4.000	G 6"	11.000	2" - 4 1/2 UNC	4.500
M 42	4.500	W 2 1/2"	4.000			2 1/4" - 4 1/2 UNC	4.500
M 45	4.500	W 2 3/4"	3.500			2 1/2" - 4 UNC	4.000
M 48	5.000	W 3"	3.500			2 3/4" - 4 UNC	4.000
M 52	5.000	W 3 1/4"	3.250			3" - 4 UNC	4.000
M 56	5.500	W 3 1/2"	3.250			3 1/4" - 4 UNC	4.000
M 60	5.500	W 3 3/4"	3.000			3 1/2" - 4 UNC	4.000
M 64	6.000	W 4"	3.000			3 3/4" - 4 UNC	4.000
M 68	6.000					4" - 4 UNC	4.000

Thread table with pitches

Cycle description**1. Step**

- 1 The control system positions the tool in the spindle axis in rapid traverse (G0) to the safety distance above the reference point.
- 2 The tool moves with the programmed speed (S) or cutting speed (V) to the thread depth (Z1).
- 3 After reaching the thread depth (Z1) the spindle stops and reverses direction.
- 4 The tool reverses with the spindle speed (SR) or cutting speed (VR) to the safety distance.
- 5 The tool reverses in rapid traverse (G0) to the coordinates of the drill hole center on the retraction plane.

- 7 The tool moves out of the workpiece with spindle speed (SR) or cutting speed (VR). The spindle stops and the tool moves back in rapid traverse (G0) to the coordinates of the drill hole center on the retraction plane.

**Instructions:**

When single block processing (SBL) is active, the thread tapping will be carried out without block interruption.

Cycle description**Chip clearing**

- 1 The tool drills with the programmed speed (S) or cutting speed (V) to the 1st infeed depth (maximum depth infeed D).
- 2 Spindle stop.
- 3 The tool moves out of the workpiece for chip clearing with spindle speed (SR) or cutting speed (VR).
- 4 Spindle stop.
- 5 The tool drills with spindle depth (S) or cutting speed (V) to the next infeed depth.
- 6 Repeat steps 2 to 5 until the programmed end drilling depth (Z1) is reached.

Cycle description**Chip crushing**

- 1 The tool drills with the programmed speed (S) or cutting speed (V) to the 1st infeed depth (maximum depth infeed D).
- 2 Spindle stop.
- 3 The tool moves back by the retraction amount (V2) for chip crushing.
- 4 The tool drills with spindle depth (S) or cutting speed (V) to the next infeed depth.
- 5 Repeat steps 2 to 4 until the programmed end drilling depth (Z1) is reached.
- 7 The tool moves out of the workpiece with spindle speed (SR) or cutting speed (VR). The spindle stops and the tool moves back in rapid traverse (G0) to the coordinates of the drill hole center on the retraction plane.

Drill. Centering **Centering**

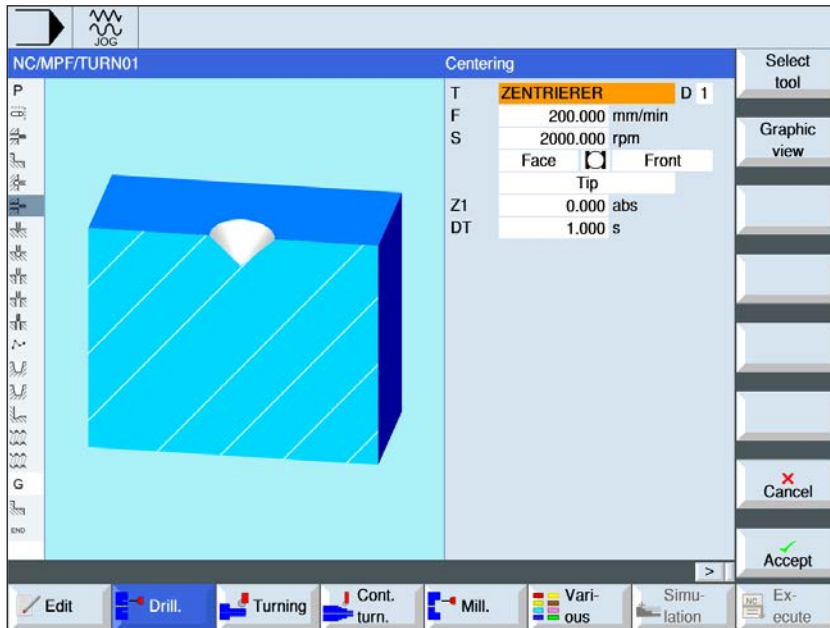

The "Select" button gives you the option to change parameters and/or units. To do this move the cursor to the appropriate field and press button.

Parameter	Description	Unit
T	Tool name	
D	Cutting number	
F	Feed	mm/min mm/rev
S / V	Spindle speed or constant cutting speed	rpm m/min
Machining surface	<ul style="list-style-type: none"> • Side • Front 	
Clamping	<ul style="list-style-type: none"> • Clamping on The clamping of the fixed C-axis is released. • Clamping off The C-axis is fixed in its position. The functions are dependent on the machine functions! 	
Position	<ul style="list-style-type: none"> • external • internal • in front • behind 	
Centering	<ul style="list-style-type: none"> • Diameter (centering relative to the diameter). The center drill angle indicated in the tool list will be taken into account. • Tip (centering relative to the depth) The tool plunges to the programmed plunge depth. 	

Parameter	Description	Unit
Ø	The tool plunges until the diameter is reached.	mm
Z1 X1	Drill depth (absolute) or depth relative to Z0 or X0 (incremental). The tool penetrates until Z1 or X1 is reached.	mm
DT	<ul style="list-style-type: none"> • Dwell time on the ground in seconds • Dwell time on the ground in revolutions 	s U

Cycle description

- 1 The control system positions the tool in the spindle axis in rapid traverse (G0) to the safety distance above the reference point.
- 2 The tool centers with the programmed feed (F) till the depth (Z1) or the centering diameter (Ø) is reached and dwells there (DT) - if indicated.
- 3 From the centering bottom, the tool moves back to the retraction plane in rapid traverse after the dwell time (DT) ends.

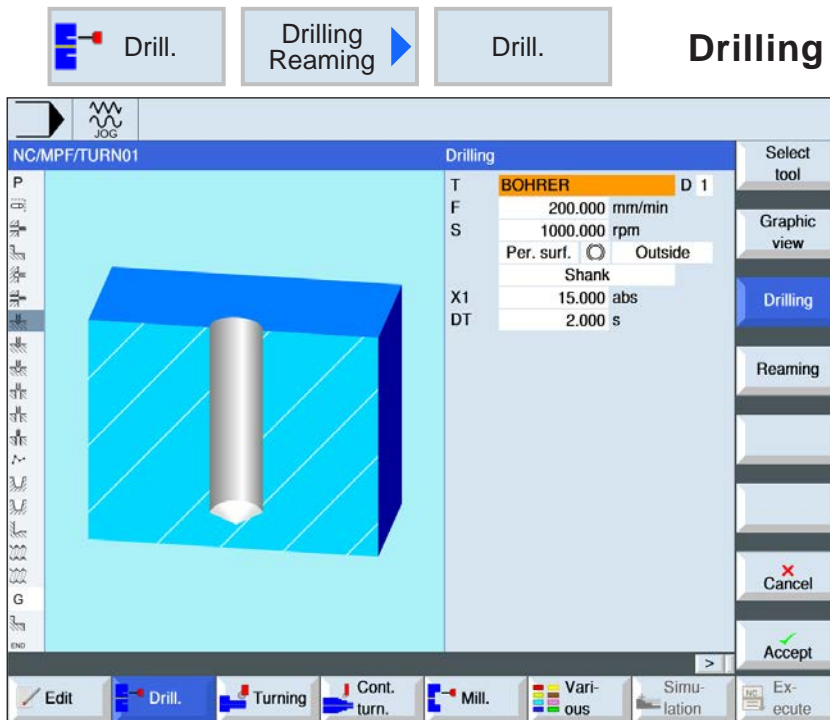

The "Select" button gives you the option to change parameters and/or units. To do this move the cursor to the appropriate field and press button.

Parameter	Description	Unit
T	Tool name	
D	Cutting number	
F	Feed	mm/min mm/rev
S / V	Spindle speed or constant cutting speed	rpm m/min
Machining surface	<ul style="list-style-type: none"> • Side • Front 	
Clamping	<ul style="list-style-type: none"> • Clamping on The clamping of the fixed C-axis is released. • Clamping off The C-axis is fixed in its position. The functions are dependent on the machine functions! 	
Position	<ul style="list-style-type: none"> • external • internal • in front • behind 	
Drill depth	<ul style="list-style-type: none"> • Shaft (drilling depth relative to the shaft). The drill plunges until the drill shaft reaches the programmed value Z1. • Tip (drill depth relative to the tip) The drill plunges until the drill tip reaches the programmed value Z1. 	mm
Z1 X1	Drill depth (absolute) or depth relative to Z0 (incremental). The tool penetrates until Z1 or X1 is reached.	mm
DT	<ul style="list-style-type: none"> • Dwell time on the ground in seconds • Dwell time on the ground in revolutions 	s U

Cycle description

- 1** The control system positions the tool in the spindle axis in rapid traverse (G0) to the safety distance above the reference point.
- 2** The tool centers with the programmed feed (F) till the depth (Z1 or X1) is reached and dwells there (DT) - if indicated.
- 3** From the drill bottom the tool moves back to the retraction plane in rapid traverse after expiry of the dwell time (DT).

Drill. Drilling Reaming **Abrading**

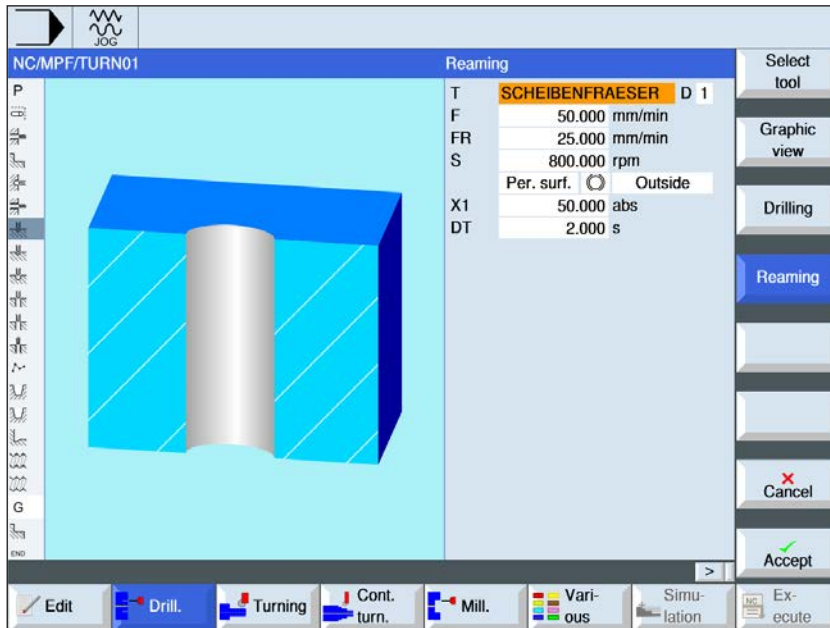

The "Select" button gives you the option to change parameters and/or units. To do this move the cursor to the appropriate field and press button.

Parameter	Description	Unit
T	Tool name	
D	Cutting number	
F	Feed	mm/min mm/rev
FR	Feed during retraction	mm/min mm/rev
S / V	Spindle speed or constant cutting speed	rpm m/min
Machining surface	<ul style="list-style-type: none"> • Side • Front 	
Clamping	<ul style="list-style-type: none"> • Clamping on The clamping of the fixed C-axis is released. • Clamping off The C-axis is fixed in its position. The functions are dependent on the machine functions! 	
Position	<ul style="list-style-type: none"> • external • internal • in front • behind 	
Z1 X1	Drill depth (absolute) or depth relative to Z0 (incremental). The tool penetrates until Z1 or X1 is reached.	mm
DT	<ul style="list-style-type: none"> • Dwell time on the ground in seconds • Dwell time on the ground in revolutions 	s U

Cycle description

- 1** The control system positions the tool in the spindle axis in rapid traverse (G0) to the safety distance above the reference point.
- 2** The tool abrades with the programmed feed (F) till the depth (Z1 or X1) is reached and dwells there (DT) - if indicated.
- 3** From the drill bottom the tool moves back to the retraction plane with retraction feed after expiry of the dwell time (DT).



Deep hole drilling

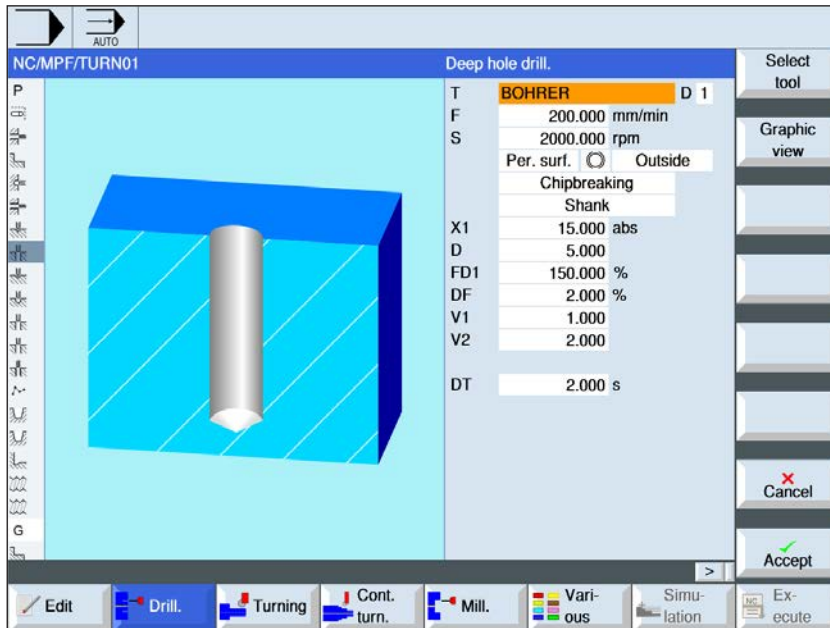

The "Select" button gives you the option to change parameters and/or units. To do this move the cursor to the appropriate field and press button.

Parameter	Description	Unit
T	Tool name	
D	Cutting number	
F	Feed	mm/min mm/rev
S / V	Spindle speed or constant cutting speed	rpm m/min
Machining surface	<ul style="list-style-type: none"> • Side • Front 	
Clamping	<ul style="list-style-type: none"> • Clamping on The clamping of the fixed C-axis is released. • Clamping off The C-axis is fixed in its position. The functions are dependent on the machine functions! 	
Position	<ul style="list-style-type: none"> • external • internal • in front • behind 	
Machining	<ul style="list-style-type: none"> • Chip clearing The drill moves completely out of the workpiece for chip clearing. • Chip crushing The drill plunges until the drill tip reaches the programmed value Z1 or X1. 	mm
Z1 X1	Drill depth (absolute) or drill depth (incremental) relative to Z0. The tool penetrates until Z1 or X1 is reached.	mm
D	maximum depth infeed	mm

Parameter	Description	Unit
Drill depth	<ul style="list-style-type: none"> • Shaft (drilling depth relative to the shaft) The drill plunges until the drill shaft reaches the programmed value Z1. The angle indicated in the tool list is also included. • Tip (drill depth relative to the tip) The drill plunges until the drill tip reaches the programmed value Z1. Instructions: If no angle for the drill can be given in the tool list, no tip/shaft selection is offered (always tip, 0 field) 	
FD1	Percentage rate for the feed during the first infeed	%
DF	Percentage rate for each additional infeed	mm %
V1	minimum depth infeed (only when DF indicated in %)	mm
Advance stop distance	<ul style="list-style-type: none"> • manually The advance stop distance must be entered manually. • automatically The advance stop distance will be calculated by the cycle. 	
V2	Retract amount after each processing (only when chip crushing selected)	mm
V3	Advanced stop distance (only when chip clearing and advanced stop distance manually selected)	mm
DT	<ul style="list-style-type: none"> • Dwell time on the ground in seconds • Dwell time on the ground in revolutions 	s U

Cycle description

Chip crushing

- 1 The control system positions the tool in the spindle axis in rapid traverse (G0) to the safety distance above the reference point.
- 2 The tool drills with the programmed spindle speed and the feed speed $F = F * FD1[\%]$ up to the 1st infeed depth.
- 3 The tool reverses by the retraction amount (V2) for chip crushing. Then the tool drills with the programmed feed (F) to the next infeed depth. This will be repeated until the end drilling depth (Z1 or X1) is reached.
- 4 From the drill bottom the tool moves back to the retraction plane in rapid traverse (G0) after expiry of the dwell time (DT).

Cycle description

Chip clearing

- 1 The control system positions the tool in the spindle axis in rapid traverse (G0) to the safety distance above the reference point.
- 2 The tool drills with the programmed spindle speed and the feed speed $F = F * FD1[\%]$ up to the 1st infeed depth.
- 3 The tool moves out of the workpiece to the safety distance in rapid traverse for chip clearing.
- 4 The tool moves in rapid traverse (G0) to the last drilling depth, reduced by the advanced stop distance (V3).
- 5 Then there will be drilling to the next infeed depth.
- 6 Steps 3 to 5 will be repeated until the programmed end drilling depth (Z1 or X1) is reached.
- 4 From the drill bottom the tool moves back to the retraction plane in rapid traverse (G0) after expiry of the dwell time (DT).



Thread tapping

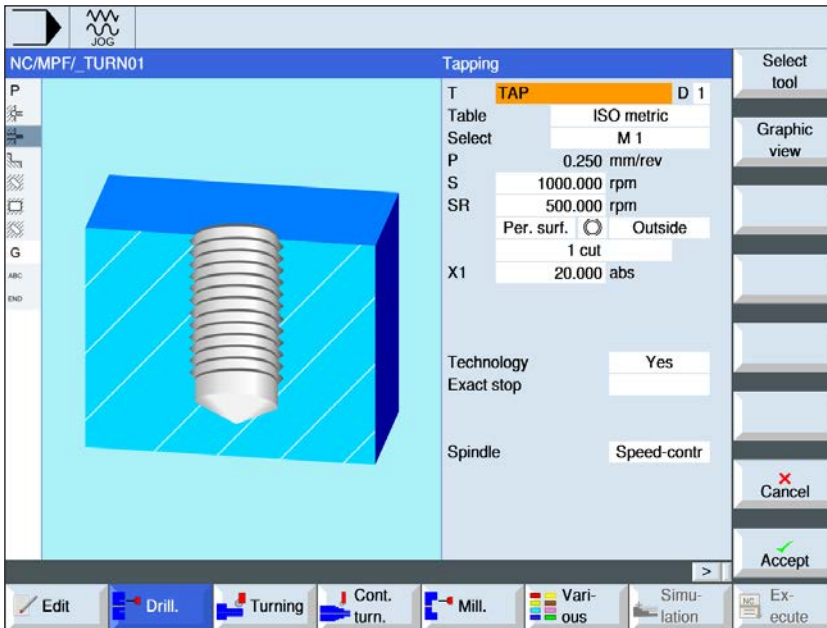

The "Select" button gives you the option to change parameters and/or units. To do this move the cursor to the appropriate field and press button.

Instructions:

This cycle is not available for the Concept TURN 155 and Concept TURN 325 machines.



Parameter	Description	Unit
T	Tool name	
D	Cutting number	
Table	Thread selection table: <ul style="list-style-type: none"> • none • ISO metric • Whitworth BSW • Whitworth BSP • UNC 	
Selection	Selection of the table value e.g.: <ul style="list-style-type: none"> • M1; M5; etc. (ISO metric) • W1/8"; etc. (Whitworth BSW) • G 1 3/4"; etc. (Whitworth BSP) • N8 - 32 UNC; etc. (UNC) (also see thread table with respective pitches)	
P	Display of the thread lead (only with table selection "none") <ul style="list-style-type: none"> • in MODULE: MODULE = pitch/π • in threads per inch: as is typical with pipe threads. With the per inch input, in the first parameter field the whole number before the decimal point is entered and in the second and third field the number after the decimal point is entered as a fraction. <ul style="list-style-type: none"> • in mm/rev • in inches/rev The thread lead is dependent on the tool used.	MODULE Threads/" mm/rev inches/rev
S / V	Spindle speed or constant cutting speed	rpm m/min

Parameter	Description	Unit
SR	Spindle speed for retraction	rpm
VR	constant cutting speed for retraction	m/min
Machining surface	<ul style="list-style-type: none"> • Side • Front 	
Clamping	<ul style="list-style-type: none"> • Clamping on The clamping of the fixed C-axis is released. • Clamping off The C-axis is fixed in its position. The functions are dependent on the machine functions! 	
Position	<ul style="list-style-type: none"> • external • internal • in front • behind 	
Machining	<ul style="list-style-type: none"> • 1 cut The thread will be drilled in one cut, without interruption. • Chip crushing The drill pulls back by the retract amount (V2) for chip crushing. • Chip clearing The drill moves completely out of the workpiece. 	
Z1	Thread end point (abs) or thread length (incr.) - (only for front machining area) Penetration is until Z1 is reached.	mm
X1	Thread end point (abs) or thread length (incr.) - (only for side machining area) Penetration is until X1 is reached.	
D	maximum depth infeed	mm
Retract	Retraction amount (only for chip crushing) <ul style="list-style-type: none"> • manually With retract amount (V2) after each processing. • automatic Without retract amount (V2) after each processing. The tool will be pulled back by one revolution after each processing. 	
V2	Retract amount after each processing Amount by which the tool will be pulled back during chip crushing	mm
Technology	<ul style="list-style-type: none"> • yes • no 	
Precision stop	<ul style="list-style-type: none"> • Behavior as it was before the cycle call-up • G601: Block advance for fine precision stop • G602: Block advance for crude precision stop Only for "Yes" technology	
Spindle	<ul style="list-style-type: none"> • governed: • position-controlled: Only for "Yes" technology	

Thread table

ISO_METRIC		WHITWORTH_BSW		WHITWORTH_BSP		UNC	
M 1	0.250	W 1/16"	60.000	G 1/16"	28.000	N 1 - 64 UNC	64.000
M 1.2	0.250	W 3/32"	48.000	G 1/8"	28.000	N 2 - 56 UNC	56.000
M 1.6	0.350	W 1/8"	40.000	G 1/4"	19.000	N 3 - 48 UNC	48.000
M 2	0.400	W 5/32"	32.000	G 3/8"	19.000	N 4 - 40 UNC	40.000
M 2.5	0.450	W 3/16"	24.000	G 1/2"	14.000	N 5 - 40 UNC	40.000
M 3	0.500	W 7/32"	24.000	G 5/8"	14.000	N 6 - 32 UNC	32.000
M 3.5	0.600	W 1/4"	20.000	G 3/4"	14.000	N 8 - 32 UNC	32.000
M 4	0.700	W 5/16"	18.000	G 7/8"	14.000	N 10 - 24 UNC	24.000
M 4.5	0.750	W 3/8"	16.000	G 1"	11.000	N 12 - 24 UNC	24.000
M 5	0.800	W 7/16"	14.000	G 1 1/8"	11.000	1/4" - 20 UNC	20.000
M 6	1.000	W 1/2"	12.000	G 1 1/4"	11.000	5/16" - 18 UNC	18.000
M 8	1.250	W 9/16"	12.000	G 1 3/8"	11.000	3/8" - 16 UNC	16.000
M 10	1.500	W 5/8"	11.000	G 1 1/2"	11.000	7/16" - 14 UNC	14.000
M 12	1.750	W 3/4"	10.000	G 1 3/4"	11.000	1/2" - 13 UNC	13.000
M 14	2.000	W 7/8"	9.000	G 2"	11.000	9/16" - 12 UNC	12.000
M 16	2.000	W 1"	8.000	G 2 1/4"	11.000	5/8" - 11 UNC	11.000
M 18	2.500	W 1 1/8"	7.000	G 2 1/2"	11.000	3/4" - 10 UNC	10.000
M 20	2.500	W 1 1/4"	7.000	G 2 3/4"	11.000	7/8" - 9 UNC	9.000
M 22	2.500	W 1 3/8"	6.000	G 3"	11.000	1" - 8 UNC	8.000
M 24	3.000	W 1 1/2"	6.000	G 3 1/4"	11.000	1 1/8" - 7 UNC	7.000
M 27	3.000	W 1 5/8"	5.000	G 3 1/2"	11.000	1 1/4" - 7 UNC	7.000
M 30	3.500	W 1 3/4"	5.000	G 3 3/4"	11.000	1 3/8" - 6 UNC	6.000
M 33	3.500	W 1 7/8"	4.500	G 4"	11.000	1 1/2" - 6 UNC	6.000
M 36	4.000	W 2"	4.500	G 5"	11.000	1 3/4" - 5 UNC	5.000
M 39	4.000	W 2 1/4"	4.000	G 6"	11.000	2" - 4 1/2 UNC	4.500
M 42	4.500	W 2 1/2"	4.000			2 1/4" - 4 1/2 UNC	4.500
M 45	4.500	W 2 3/4"	3.500			2 1/2" - 4 UNC	4.000
M 48	5.000	W 3"	3.500			2 3/4" - 4 UNC	4.000
M 52	5.000	W 3 1/4"	3.250			3" - 4 UNC	4.000
M 56	5.500	W 3 1/2"	3.250			3 1/4" - 4 UNC	4.000
M 60	5.500	W 3 3/4"	3.000			3 1/2" - 4 UNC	4.000
M 64	6.000	W 4"	3.000			3 3/4" - 4 UNC	4.000
M 68	6.000					4" - 4 UNC	4.000

Thread table with pitches

Cycle description**1 cut**

- 1 The control system positions the tool in the spindle axis in rapid traverse (G0) to the safety distance above the reference point.
- 2 The spindle will be synchronized and activated with the programmed speed (S) (dependent on %S).
- 3 The tool drills with spindle-feed-synchronization to depth (Z1 or X1).
- 4 After reaching the thread depth (Z1 or X1) the spindle stops and reverses direction.
- 5 The tool moves back to the safety distance with spindle speed for the return (SR) (dependent on %S).
- 6 Spindle stop.
- 7 The tool reverses in rapid traverse (G0) to the coordinates of the drill hole center on the retraction plane.

Cycle description**Chip clearing**

- 1 The tool drills with the programmed speed (S) (dependent on %S) to the 1st infeed depth (maximum depth infeed D).
- 2 Spindle stop.
- 3 The tool moves out of the workpiece for chip clearing with spindle speed for the return (SR) (dependent on %S).
- 4 Spindle stop.
- 5 The tool drills with spindle depth (S) to the next infeed depth.
- 6 Repeat steps 2 to 5 until the programmed end drilling depth (Z1 or X1) is reached.
- 7 The tool moves out of the workpiece with spindle speed for the return (SR) (dependent on %S). The spindle stops and the tool moves back in rapid traverse (G0) to the coordinates of the drill hole center on the retraction plane.

Cycle description**Chip crushing**

- 1 The tool drills with the programmed speed (S) (dependent on %S) to the 1st infeed depth (maximum depth infeed D).
- 2 Spindle stop.
- 3 The tool moves back by the retraction amount (V2) for chip crushing.
- 4 The tool drills with spindle speed (S) to the next infeed depth.
- 5 Repeat steps 2 to 4 until the programmed end drilling depth (Z1 or X1) is reached.
- 7 The tool moves out of the workpiece with spindle speed for the return (SR) (dependent on %S). The spindle stops and the tool moves back in rapid traverse (G0) to the coordinates of the drill hole center on the retraction plane.



Positions and position template

When programming machining cycles, there is an option to enter positions or position templates.

A position or position template will only be created after the machining cycle.

Positions or position templates allow several drill or threading operations of the same diameter to be executed together in a cycle. The defined position or a position template will be saved in the cycle list. Various templates are available for this purpose:



- Arbitrary positions
- Positioning on a line, a grid or a frame
- Positioning on full or partial circle

Several position templates can be programmed successively. They will be covered in the programmed sequence.

The previously programmed technologies and the subsequently programmed positions will be automatically chained.

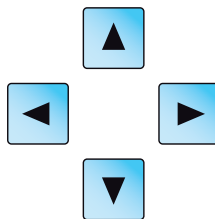

If there are more cycles than are shown in the window, use the cursor keys to scroll through the list.

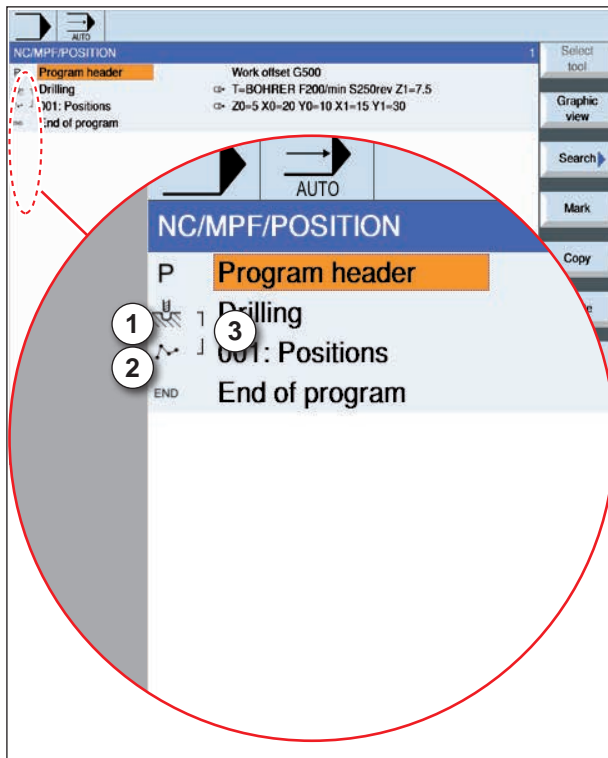

Link representation of position templates with cycles:

A complete processing cycle consists of the processing cycle (1) and the associated position template (2).

The programming sequence must be observed: First the processing cycle (e.g. drilling) is created and then the position template.

The control system links both program parts with a symbolic bracket (3) in the cycle list.

Cycle description

- 1 The control system positions the programmed tool in the preceding cycle. Machining always begins at the reference point.
- 2 Within a position template and when approaching the next position template there will be a movement back to the retract plane and then the new position or the new position template will be approached in rapid traverse (G0).
- 3 With technological follow-up operations (e.g. Centering - Drilling - Thread tapping), after calling up the next tool (e.g. drill), the particular drilling cycle is to be programmed and the calling up of the position template executed immediately afterwards.

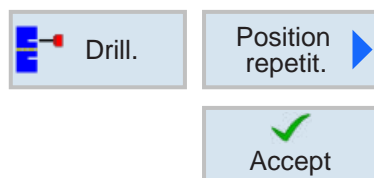

Repeat positions

Press softkey for repeated approach of already programmed positions.

- Indicate and confirm the number of the position template.
The position number will be assigned automatically when a position is created in the cycle list. In the cycle list, the position number appears to the left of the position name.



Arbitrary positions

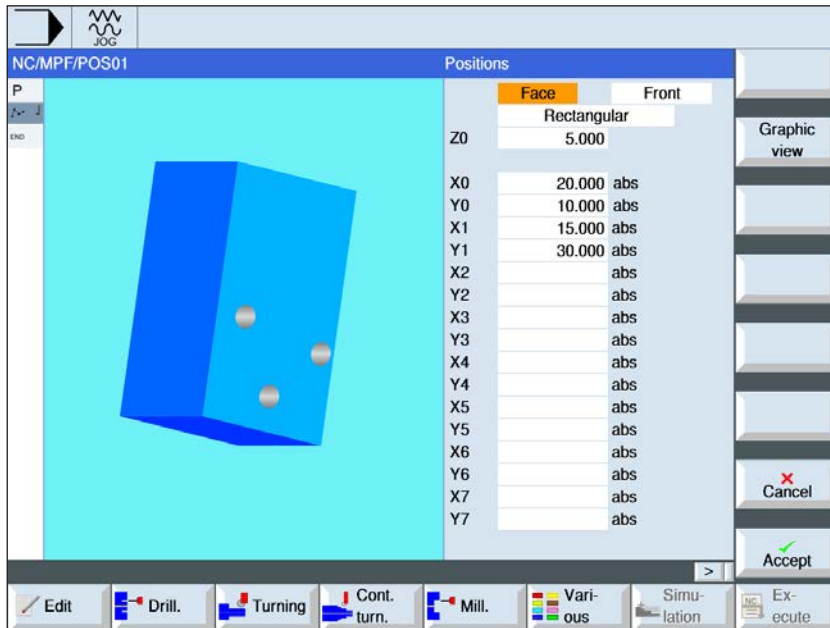

The "Select" button gives you the option to change parameters and/or units. To do this move the cursor to the appropriate field and press button.

Parameter	Description	Unit
Machining surface	<ul style="list-style-type: none"> • Side • Front Note that clamping for machining in the front and side planes remains active only for the drilling process.	
Position	<ul style="list-style-type: none"> • in front (for machining the front surface) • behind (for machining the front surface) • external (for machining the side surface) • internal (for machining the side surface) 	
Selection	Coordinate system <ul style="list-style-type: none"> • orthogonal • polar 	
Z0 X0, Y0	front, orthogonally: Z-coordinate of the reference point (absolute) X, Y coordinates of the 1st position (absolute)	mm
Z0 L0, C0	Polar front: Z-coordinate of the reference point (absolute) Polar coordinates of the 1st position Length (absolute) Angle (absolute)	mm Degrees

Parameter	Description	Unit
X0 Y0, Z0	Side orthogonally: Cylinder diameter \varnothing (absolute) X, Z coordinates of the 1st position (absolute)	mm
Z0 C0	Side cylindrically: 1. Position of the drilling referred to the Z-axis (abs) C-coordinate of the 1st position (absolute)	mm Degrees
Z1...Z7	Z-coordinates of other positions(abs or incr.)	mm
X1...X7 Y1...Y7	X-coordinates of the other positions (absolute or incremental) Y-coordinates of the other positions (absolute or incremental)	mm
L1...L7 C1...C7	Polar coordinates of other positions, only if "polar" selected Length (absolute) Angle (absolute)	mm Degrees

Cycle description

- 1 Individual positions are approached in the programmed sequence.

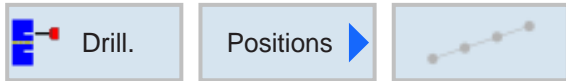

Position template line, grid or frame

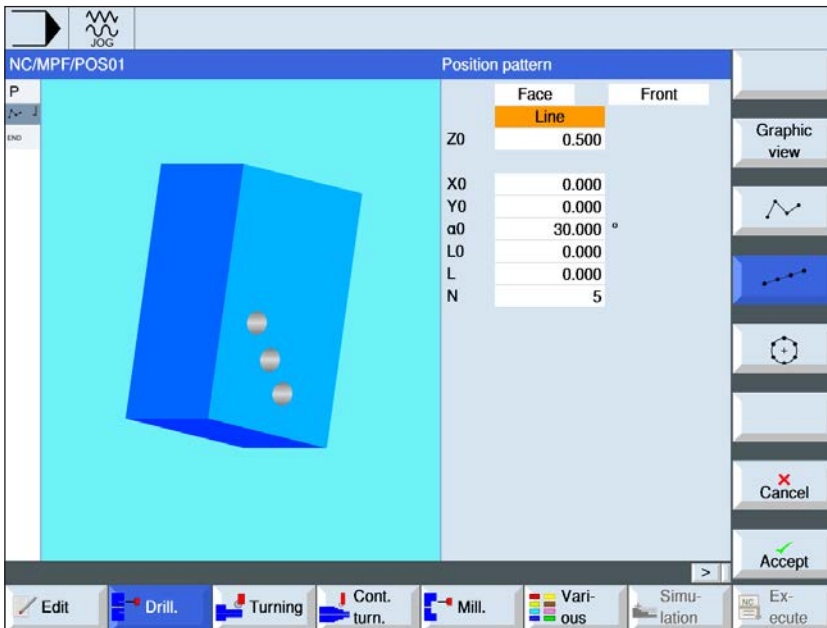

The "Select" button gives you the option to change parameters and/or units. To do this move the cursor to the appropriate field and press button.

Parameter	Description	Unit
Machining surface	<ul style="list-style-type: none"> • Side • Front Note that clamping for machining in the front and side planes remains active only for the drilling process.	
Position	<ul style="list-style-type: none"> • in front (for machining the front surface) • behind (for machining the front surface) • external (for machining the side surface) • internal (for machining the side surface) 	
Position template	<ul style="list-style-type: none"> • Line • Grid • Frame 	
Z0 X0, Y0	Front: Reference point Z Coordinate of the reference point - first position (absolute).	mm
α0	Angle of the line, relative to the X-axis Positive angle: Line will be rotated counter-clockwise. Negative angle: Line will be rotated clockwise.	Degrees
Z0 X0, Y0	Side: Cylinder diameterØ (abs) Coordinate of the reference point - first position (absolute).	mm
L0	Distance from 1st position to reference point (only when "Position template line" selected)	mm
L	Distance between the positions - (only when "Position template line" selected)	mm

Parameter	Description	Unit
N	Number of positions - (only when "Line" selected)	
$\alpha X, \alpha Y$	Shear angle X, Y - (only for position template grid or frame)	Degrees
L1 L2	Spacing of lines and columns - (only when "Position template grid or frame" selected)	mm
N1 N2	Number of lines and columns - (only when "Position template grid or frame" selected)	

Cycle description**Grid**

- 1 With a grid, machining is first in the direction of the 1st axis and then continues in a loop.

Cycle description**Frame**

- 1 With frame additional machining will be in the counter-clockwise direction.



Position template circle

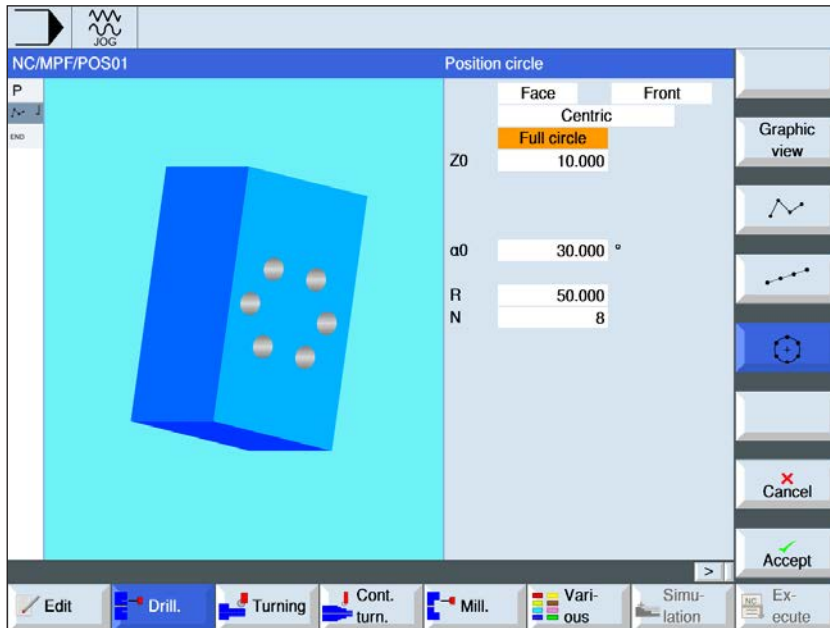

The "Select" button gives you the option to change parameters and/or units. To do this move the cursor to the appropriate field and press button.

Parameter	Description	Unit
Machining surface	<ul style="list-style-type: none"> • Side • Front Note that clamping for machining in the front and side planes remains active only for the drilling process.	
Position	<ul style="list-style-type: none"> • in front (for machining the front surface) • behind (for machining the front surface) • external (for machining the side surface) • internal (for machining the side surface) 	
Siting of the Positions	<ul style="list-style-type: none"> • centrally • eccentrically Only for front machining surface	
Circle template	<ul style="list-style-type: none"> • Full circle • Partial circle 	
Z0 X0, Y0	Front: Z-coordinate of the reference point (absolute) Coordinates of the reference point (abs) - only for eccentric	mm
Z0 X0	Side: Cylinder diameterØ (abs) Z-coordinate of the reference point (absolute)	mm

Parameter	Description	Unit
$\alpha 0$	Start angle for first position Positive angle: Full circle will be rotated counter-clockwise. Negative angle: Full circle will be rotated clockwise.	Degrees
$\alpha 1$	Angle of advance (only with "partial circle template" selected) After the first drill hole is finished, all further positions will be positioned onward by this angle. Positive angle: further positions will be rotated counter-clockwise. Negative angle: further positions will be rotated clockwise.	Degrees
R	Radius	mm
N	Number of positions	
Positioning	Positioning movement between the positions <ul style="list-style-type: none"> • Straight line Next position will be approached in rapid traverse (G0) in a straight line. • Circle Next position will be approached on a circular path with the programmed feed (FP). 	

Cycle description

- 1 The circle template must be machined further in the clockwise or counterclockwise sense.



Turn

- Machining
- Grooving
- Thread undercut
- Thread
- Grooving



Machining 1

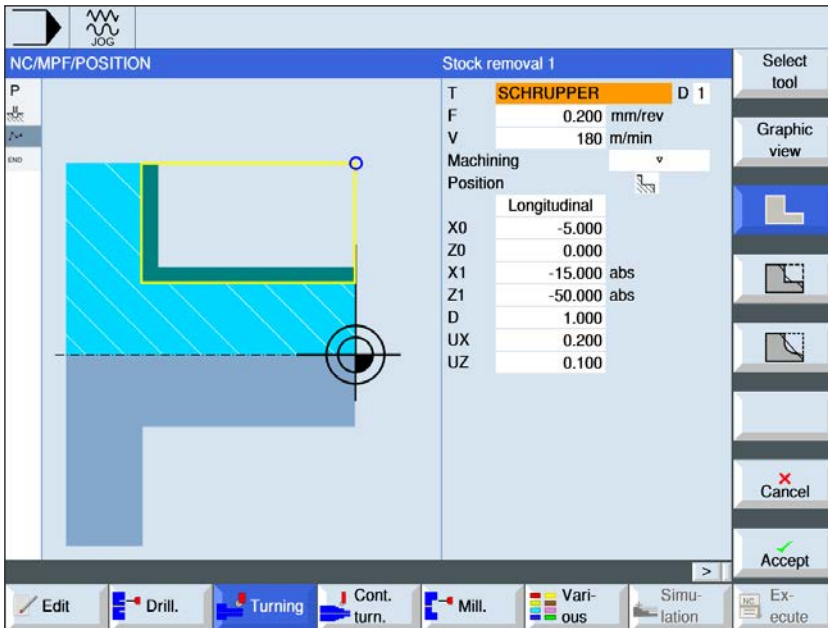

The "Select" button gives you the option to change parameters and/or units. To do this move the cursor to the appropriate field and press button.

Select machining cycle

For each desired movement press the corresponding softkey. The limits are shown by the control system.



- Machining 1

Parameter	Description	Unit
T	Tool name	
D	Cutting number	
F	Feed	mm/rev
S / V	Spindle speed or constant cutting speed	rpm m/min
Machining	<ul style="list-style-type: none"> • ▾ Roughing • ▾ ▾ Finishing 	

Parameter	Description	Unit
Position	Machining position	
Machining direction	alternating machining direction <ul style="list-style-type: none"> • Plane • Longitudinally 	
X0	Reference point in X Ø (absolute, always diameter)	mm
Z0	Reference point in Z (absolute)	mm
X1	End point X (absolute) or endpoint X referred to X0 (incremental)	
Z1	End point Z (absolute) or endpoint Z referred to Z0 (incremental)	
D	Maximum infeed depth - (not for finishing)	mm
UX	Finishing allowance in X- (not for ▽ ▽ ▽ finishing)	mm
UZ	Finishing allowance in Z- (not for ▽ ▽ ▽ finishing)	mm



Machining 2

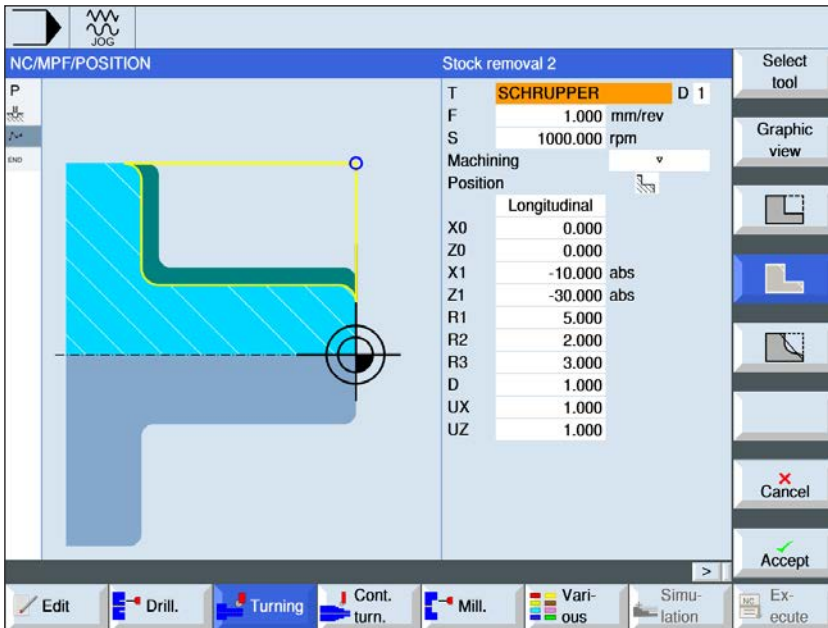

The "Select" button gives you the option to change parameters and/or units. To do this move the cursor to the appropriate field and press button.

Select machining cycle

For each desired movement press the corresponding softkey. The limits are shown by the control system.



- Machining 2

Parameter	Description	Unit
T	Tool name	
D	Cutting number	
F	Feed	mm/rev
S / V	Spindle speed or constant cutting speed	rpm m/min
Machining	<ul style="list-style-type: none"> • ▾ Roughing • ▾ ▾ Finishing 	

Parameter	Description	Unit
Position	Machining position	
Machining direction	alternating machining direction <ul style="list-style-type: none"> • Plane • Longitudinally 	
X0	Reference point in X Ø (absolute, always diameter)	mm
Z0	Reference point in Z (absolute)	mm
X1	End point X (absolute) or endpoint X referred to X0 (incremental)	
Z1	End point Z (absolute) or endpoint Z referred to Z0 (incremental)	
FS1...FS3 or R1...R3	Bevel width (FS1...FS3) or rounding radius (R1...R3)	mm
D	Maximum infeed depth - (not for ▽ ▽ ▽ finishing)	mm
UX	Finishing allowance in X – (not for ▽ ▽ ▽ finishing)	mm
UZ	Finishing allowance in Z – (not for ▽ ▽ ▽ finishing)	mm



Machining 3

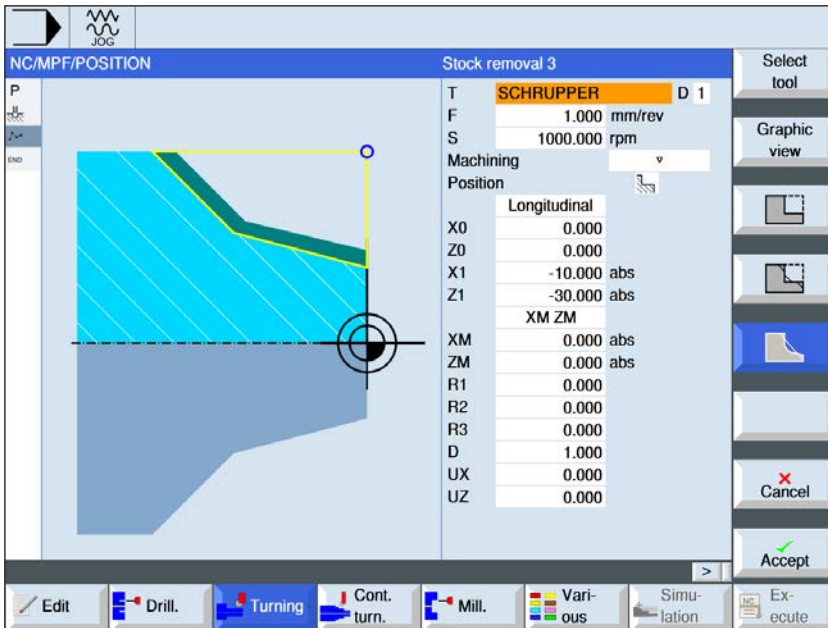

The "Select" button gives you the option to change parameters and/or units. To do this move the cursor to the appropriate field and press button.

Select machining cycle

For each desired movement press the corresponding softkey. The limits are shown by the control system.



- Machining 3

Parameter	Description	Unit
T	Tool name	
D	Cutting number	
F	Feed	mm/rev
S / V	Spindle speed or constant cutting speed	rpm m/min
Machining	<ul style="list-style-type: none"> • ▾ Roughing • ▾ ▾ Finishing 	

Parameter	Description	Unit
Position	Machining position	
Machining direction	alternating machining direction <ul style="list-style-type: none"> • Plane • Longitudinally 	
X0	Reference point in X Ø (absolute, always diameter)	mm
Z0	Reference point in Z (absolute)	mm
X1	End point X (absolute) or endpoint X referred to X0 (incremental)	
Z1	End point Z (absolute) or endpoint Z referred to Z0 (incremental)	
FS1...FS3 or R1...R3	Bevel width (FS1...FS3) or rounding radius (R1...R3)	mm
	Interim point parameter selection The interim point can be defined by positional or angle details. The following combinations are possible <ul style="list-style-type: none"> • XM ZM • XM α1 • XM α2 • α1 ZM • α2 ZM • α1 α2 	
XM	Interim point X Ø (absolute) or interim point X relative to X0 (incremental)	
ZM	Interim point Z (absolute or incremental)	
α1	1st bevel angle	Degrees
α2	2nd bevel angle	Degrees
D	Maximum infeed depth - (not for ▽ ▽ ▽ finishing)	mm
UX	Finishing allowance in X- (not for ▽ ▽ ▽ finishing)	mm
UZ	Finishing allowance in Z- (not for ▽ ▽ ▽ finishing)	mm

Machining type roughing

For roughing, cuts parallel to the axis are made until the programmed finishing allowance is generated. If no finishing allowance is programmed, then the workpiece is machined with roughing until the end contour is reached.

The cycle reduces when roughing the programmed infeed depth D so that equally large cuts are created.

If the total infeed depth is, say, 10 and an infeed depth of 3 was entered, there will be cuts of 3, 3, 3 and 1. The cycle reduces the infeed depth to 2.5, so that 4 cuts of equal size are generated.

Whether the tool traces the contour at the end of each cut by the infeed depth D, so that remaining corners are removed, or lifts off immediately, is dependent on the angle between contour and tool cut. Which angle is traced is stored in a machine datum.

**Instructions:**

When machining a corner, the safety distance in this cycle is also limited by setting data. In each case, the lower value is taken for machining.
Please observe the machine manufacturer's details in this context.

Cycle description

1. The control system positions the tool in the spindle axis in rapid traverse (G0) to the safety distance above the reference point.
2. The tool moves back to the 1st infeed depth in rapid traverse.
3. The first cut is machined with the machining feed.
4. The tool traces the contour with machine feed or lifts off in rapid traverse (see Roughing section).
5. The tool moves in rapid traverse to the start point for the next infeed depth.
6. The next cut is machined with the machining feed.
7. Steps 4 to 6 are repeated until the final depth is reached.
8. The tool withdraws to the safety distance in rapid traverse.



Grooving 1

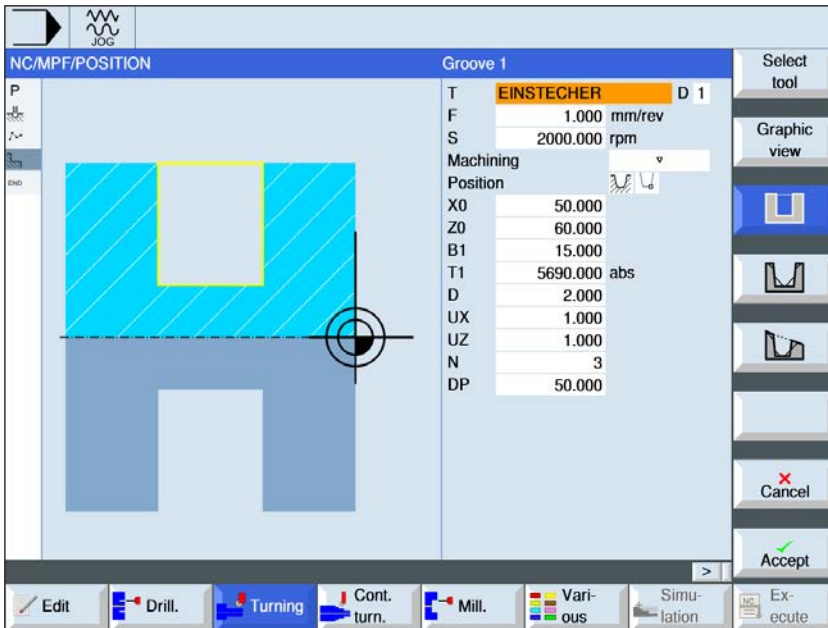

The "Select" button gives you the option to change parameters and/or units. To do this move the cursor to the appropriate field and press button.

Select grooving cycle

For each desired movement press the corresponding softkey. The limits are shown by the control system.



- Groove 1

Parameter	Description	Unit
T	Tool name	
D	Cutting number	
F	Feed	mm/rev
S / V	Spindle speed or constant cutting speed	rpm m/min
Machining	<ul style="list-style-type: none"> • ▾ Roughing • ▾ ▾ Finishing • ▾ + ▾ ▾ (Roughing and finishing) 	

Parameter	Description	Unit
Position	Machining position	
X0	Reference point in X Ø	mm
Z0	Reference point in Z	mm
B1	Groove width	mm
T1	Groove depthØ (abs) or end point relative to X0 (incr.)	
D	<ul style="list-style-type: none"> • Maximum infeed depth for penetration – (only for ▽ and ▽+▽▽▽) • For zero: Penetration in a single cut – (only for ▽ and ▽+▽▽▽) D = 0: 1. cut is made directly to final depth D1. D = 0: The 1st and 2nd cuts are made alternately around the infeed depth D, to achieve better chip flow and avoid the tool breaking, see approach/withdrawal when roughing. An alternating cut is not possible if the tool can reach the bottom of the groove at only one position.	mm
UX or U	Finishing allowance in X or finishing allowance in X and Z – (only for ▽ and ▽+▽▽▽)	mm
UZ	Finishing allowance in Z – (for UX, only for ▽ and ▽+▽▽▽)	mm
N	Number of grooves (N = 1...65535)	
DP	Groove spacing (incr.) For N = 1, DP is not shown	mm



Grooving 2

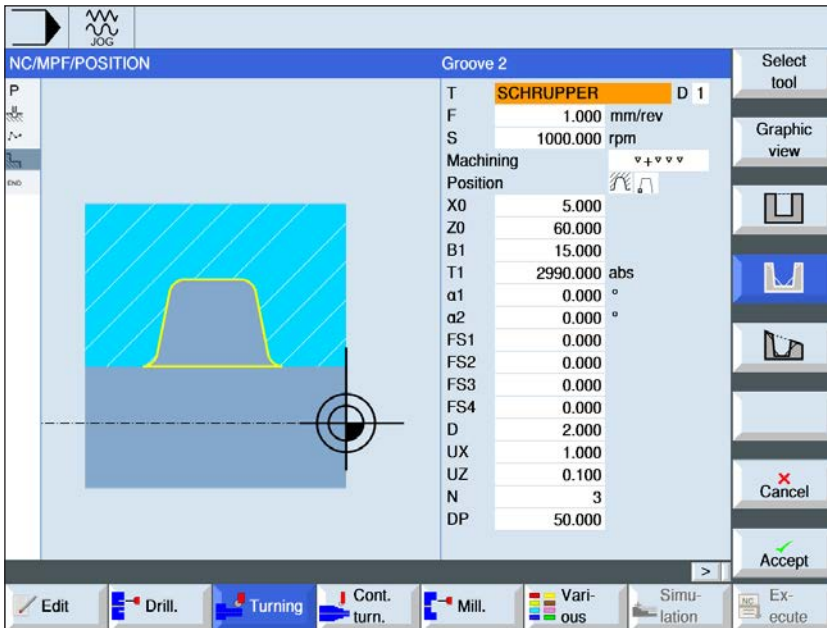

The "Select" button gives you the option to change parameters and/or units. To do this move the cursor to the appropriate field and press button.

Select grooving cycle

For each desired movement press the corresponding softkey. The limits are shown by the control system.



- Groove 2

Parameter	Description	Unit
T	Tool name	
D	Cutting number	
F	Feed	mm/rev
S / V	Spindle speed or constant cutting speed	rpm m/min
Machining	<ul style="list-style-type: none"> • ▾ Roughing • ▾ ▾ Finishing • ▾ ▾ ▾ (Roughing and finishing) 	

Parameter	Description	Unit
Position	Machining position	
X0	Reference point in X \emptyset	mm
Z0	Reference point in Z	mm
B1	Groove width	mm
T1	Groove depth \emptyset (abs) or end point relative to X0 (incr.)	
D	<ul style="list-style-type: none"> • Maximum infeed depth for penetration – (only for ∇ and $\nabla + \nabla \nabla \nabla$) • For zero: Penetration in a single cut – (only for ∇ and $\nabla + \nabla \nabla \nabla$) D = 0: 1. cut is made directly to final depth D1. D = 0: The 1st and 2nd cuts are made alternately around the infeed depth D, to achieve better chip flow and avoid the tool breaking, see approach/withdrawal when roughing. An alternating cut is not possible if the tool can reach the bottom of the groove at only one position.	mm
UX or U	Finishing allowance in X or finishing allowance in X and Z – (only for ∇ and $\nabla + \nabla \nabla \nabla$)	mm
UZ	Finishing allowance in Z – (for UX, only for ∇ and $\nabla + \nabla \nabla \nabla$)	mm
N	Number of grooves (N = 1...65535)	
DP	Groove spacing (incr.) For N = 1, DP is not shown	mm
$\alpha 1$ $\alpha 2$	Edge angle 1 or edge angle 2 - (only for grooves 2 and 3) Asymmetrical grooves can be described by separate angles. The angles can take values between 0 and $< 90^\circ$.	Degrees
FS1...FS4 or R1...R4	Bevel width (FS1...FS4) or rounding radius (R1...R4) - (only for grooves 2 and 3)	mm



Grooving 3

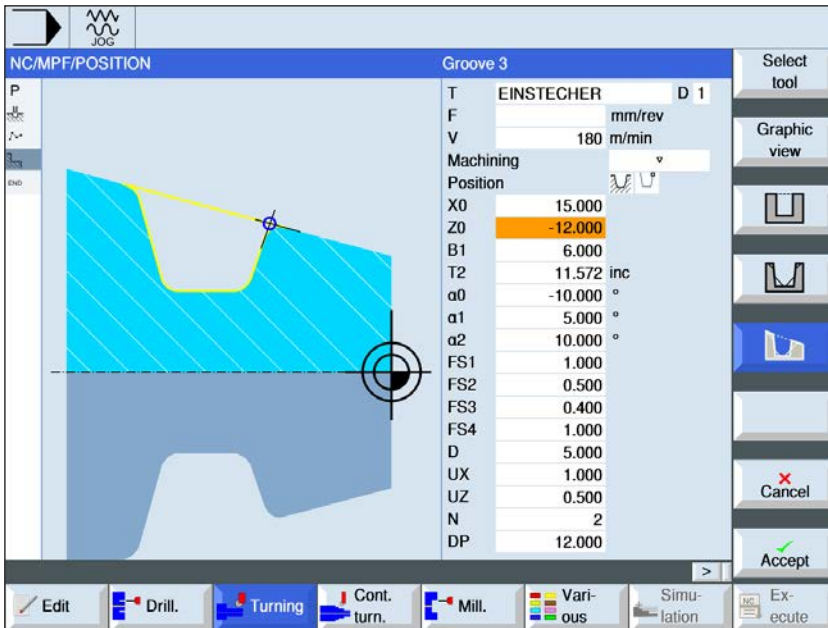

The "Select" button gives you the option to change parameters and/or units. To do this move the cursor to the appropriate field and press button.

Select grooving cycle

For each desired movement press the corresponding softkey. The limits are shown by the control system.



- Groove 3

Parameter	Description	Unit
T	Tool name	
D	Cutting number	
F	Feed	mm/rev
S / V	Spindle speed or constant cutting speed	rpm m/min
Machining	<ul style="list-style-type: none"> • ▾ Roughing • ▾ ▾ Finishing • ▾ + ▾ ▾ (Roughing and finishing) 	

Parameter	Description	Unit
Position	Machining position	
X0	Reference point in X \emptyset	mm
Z0	Reference point in Z	mm
B1	Groove width	mm
T1	Groove depth at reference point \emptyset (abs) or groove depth at reference point (incr.)	
T2	Groove depth opposite reference point \emptyset (abs) or ABS or groove depth opposite reference point (incr.)	
D	<ul style="list-style-type: none"> • Maximum infeed depth for penetration – (only for ▽ and ▽+▽▽▽) • For zero: Penetration in a single cut – (only for ▽ and ▽+▽▽▽) D = 0: 1. cut is made directly to final depth D1. D = 0: The 1st and 2nd cuts are made alternately around the infeed depth D, to achieve better chip flow and avoid the tool breaking, see approach/withdrawal when roughing. An alternating cut is not possible if the tool can reach the bottom of the groove at only one position.	mm
UX or U	Finishing allowance in X or finishing allowance in X and Z – (only for ▽ and ▽+▽▽▽)	mm
UZ	Finishing allowance in Z – (for UX, only for ▽ and ▽+▽▽▽)	mm
N	Number of grooves (N = 1....65535)	
DP	Groove spacing (incr.) For N = 1, DP is not shown	mm
α_0	Oblique angle - (only for groove 3)	Degrees
α_1 α_2	Edge angle 1 or edge angle 2 - (only for grooves 2 and 3) Asymmetrical grooves can be described by separate angles. The angles can take values between 0 and $< 90^\circ$.	Degrees
FS1...FS4 or R1...R4	Bevel width (FS1...FS4) or rounding radius (R1...R4) - (only for grooves 2 and 3)	mm

Roughing cycle description

1. The tool moves in rapid traverse only to the startpoint calculated within the cycle.
2. The tool cuts a groove in the center by the infeed depth D .
- 3 The tool withdraws by $D +$ the safety distance in rapid traverse.
4. The tool cuts a groove in addition to the first groove by the infeed depth $2 \cdot D$.
- 5 The tool withdraws by $D +$ the safety distance in rapid traverse.
6. The tool cuts grooves alternately in the 1st and 2nd grooves by the infeed depth $2 \cdot D$, until the final depth $D1$ is reached.
Between the individual grooves, the tool withdraws in rapid traverse each time by $D +$ the safety distance. After the last groove, the tool withdraws in rapid traverse to the safety distance.
7. All further grooves are finished directly to the final depth $D1$.
Between the individual grooves, the tool withdraws in rapid traverse each time to the safety distance.

Finishing cycle description

1. The tool moves in rapid traverse only to the startpoint calculated within the cycle.
2. The tool moves with machining feed down to an edge and then advances on the ground to the center.
- 3 The tool withdraws to the safety distance in rapid traverse.
4. The tool moves with machining feed along to the other edge and then advances on the ground to the center.
- 5 The tool withdraws to the safety distance in rapid traverse.



Free grooving

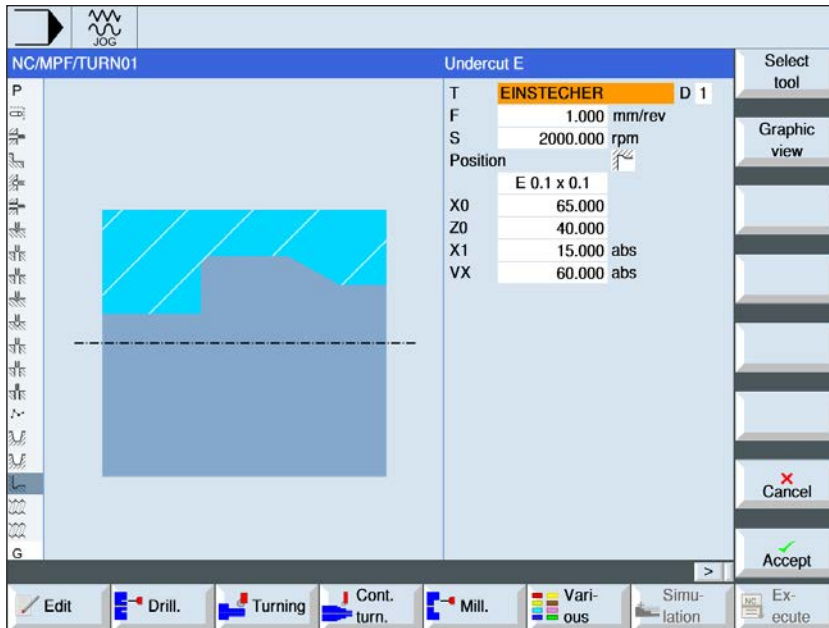

The "Select" button gives you the option to change parameters and/or units. To do this move the cursor to the appropriate field and press button.

Select free grooving cycle

For each desired movement press the corresponding softkey. The limits are shown by the control system.

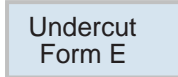

- Free grooving form E

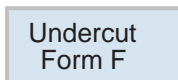

- Free grooving form F

Parameter	Description	Unit
T	Tool name	
D	Cutting number	
F	Feed	mm/rev
S / V	Spindle speed or constant cutting speed	rpm m/min

Parameter	Description	Unit
Position	Machining position: Form E and Form F	
Free grooving variable according to DIN table	e.g.: E1.0 x 0.1 (free groove form E) e.g.: F0.6 x 0.3 (free groove form F)	
X0 Z0	Coordinate of the reference point (absolute).	mm
X1	Allowance in X Ø (abs) or allowance in X (incr.)	mm
Z1	Allowance in Z (abs) or allowance in Z (incr.) - (only for free groove form F)	mm
VX	Plane Ø (abs) or plane (incr.)	mm

Grooving cycle description

1. The tool moves in rapid traverse only to the startpoint calculated within the cycle.
2. Free grooving is finished in a single step with machining feed, beginning at the edge and ending at plane VX.
3. The tool withdraws to the start point in rapid traverse.



Free groove, DIN thread

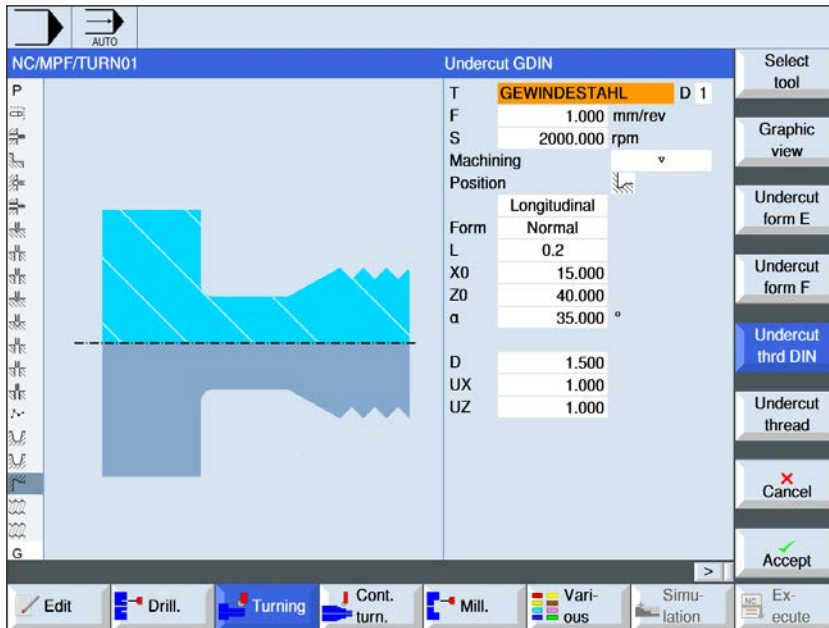

The "Select" button gives you the option to change parameters and/or units. To do this move the cursor to the appropriate field and press button.

Parameter	Description	Unit
T	Tool name	
D	Cutting number	
F	Feed	mm/rev
S / V	Spindle speed or constant cutting speed	rpm m/min
Machining	<ul style="list-style-type: none"> • ▾ Roughing • ▾ ▾ Finishing • ▾ + ▾ ▾ (Roughing and finishing) 	
Position	Machining position:	
Direction	Machining direction: <ul style="list-style-type: none"> • longitudinally • parallel to the contour 	
Form	Machining form: <ul style="list-style-type: none"> • normal • short 	
P	Thread pitch (select or enter from DIN table provided)	mm/rev

Parameter	Description	Unit
X0 Z0	Coordinate of the reference point (absolute).	mm
α	Penetration angle	degrees
VX	Plane \emptyset (absolute) or plane (incremental) - (only for $\nabla \nabla \nabla$ and $\nabla + \nabla \nabla \nabla$).	mm
D	maximum infeed depth – (only for ∇ and $\nabla + \nabla \nabla \nabla$).	mm
U or UX	Finishing allowance in X or finishing allowance in X and Z – (only for ∇ and $\nabla + \nabla \nabla \nabla$).	mm
UZ	Finishing allowance in Z – (only for UX, ∇ and $\nabla + \nabla \nabla \nabla$).	mm

Grooving cycle description

1. The tool moves in rapid traverse only to the startpoint calculated within the cycle.
2. The 1st cut is done with machine feed beginning at the thread along the form of the thread free groove as far as the safety distance.
3. The tool moves back to the next start position in rapid traverse.
4. Steps 2 to 3 are repeated until the thread groove is finished completely.
5. The tool withdraws to the start point in rapid traverse.

When finishing, the tool moves to the plane VX.



Free groove thread

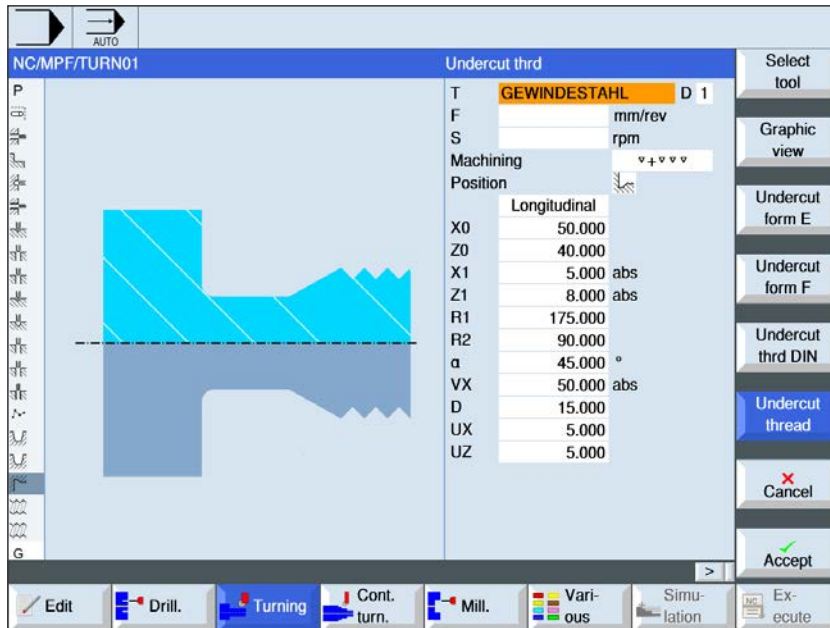

The "Select" button gives you the option to change parameters and/or units. To do this move the cursor to the appropriate field and press button.

Parameter	Description	Unit
T	Tool name	
D	Cutting number	
F	Feed	mm/rev
S / V	Spindle speed or constant cutting speed	rpm m/min
Machining	<ul style="list-style-type: none"> ▾ Roughing ▾ ▾ ▾ Finishing ▾ + ▾ ▾ ▾ (Roughing and finishing) 	
Position	Machining position:	
Direction	Machining direction: <ul style="list-style-type: none"> • longitudinally • parallel to the contour 	
X0 Z0	Coordinate of the reference point (absolute).	mm

Parameter	Description	Unit
X1	Groove depth relative to X Ø (absolute) or groove depth relative to X (incremental)	
Z1	Allowance Z (absolute or incremental)	
R1 R2	Rounding radius 1 Rounding radius 2	mm
α	Penetration angle	degrees
VX	Plane Ø (absolute) or plane (incremental) - (only for ▽ ▽ ▽ and ▽ + ▽ ▽ ▽).	mm
D	maximum infeed depth – (only for ▽ and ▽ + ▽ ▽ ▽).	mm
U or UX	Finishing allowance in X or finishing allowance in X and Z – (only for ▽ and ▽ + ▽ ▽ ▽).	mm
UZ	Finishing allowance in Z – (only for UZ, ▽ and ▽ + ▽ ▽ ▽).	mm

Grooving cycle description

1. The tool moves in rapid traverse only to the startpoint calculated within the cycle.
2. The 1st cut is done with machine feed beginning at the thread along the form of the thread free groove as far as the safety distance.
3. The tool moves back to the next start position in rapid traverse.
4. Steps 2 to 3 are repeated until the thread groove is finished completely.
5. The tool withdraws to the start point in rapid traverse.

When finishing, the tool moves to the plane VX.



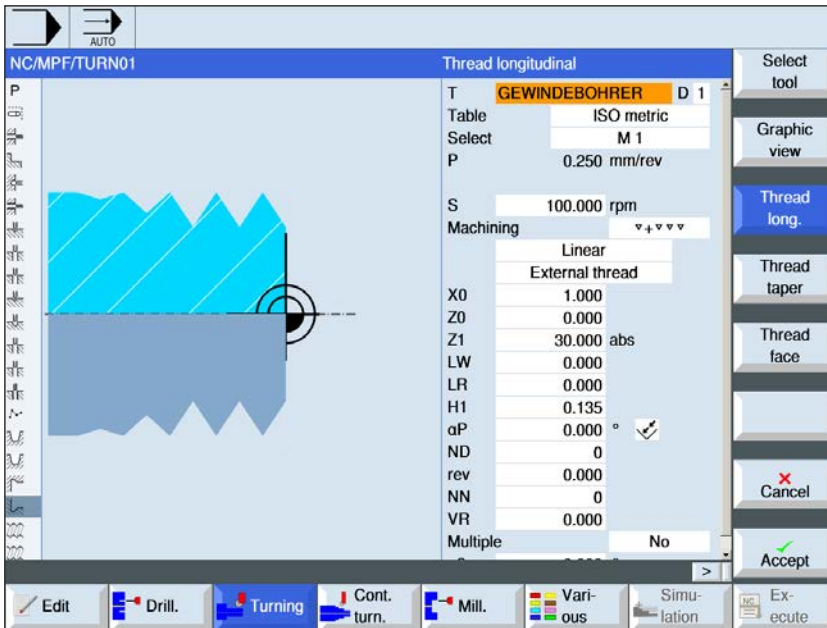

Thread longitudinally



The "Select" button gives you the option to change parameters and/or units. To do this move the cursor to the appropriate field and press button.

Parameter	Description	Unit
T	Tool name	
D	Cutting number	
Table	Thread selection table: <ul style="list-style-type: none"> • none • ISO metric • Whitworth BSW • Whitworth BSP • UNC 	
Selection	Selection of the table value e.g.: <ul style="list-style-type: none"> • M1; M5; etc. (ISO metric) • W1/8"; etc. (Whitworth BSW) • G 1 3/4"; etc. (Whitworth BSP) • N8 - 32 UNC; etc. (UNC) (also see thread table with respective pitches)	
P	Selection of pitch/threads for "none" table or details of pitch/threads according to the thread table selection: <ul style="list-style-type: none"> • Pitch in mm/revolution • Pitch in inches/revolution • Threads per inch • Pitch in MODUL. 	Threads/" MODULE mm/rev inches/rev

Parameter	Description	Unit
S / V	Spindle speed or constant cutting speed	rpm m/min
G	<p>Change of pitch per revolution - (only for P = mm/rev or in/rev) G = 0: The pitch P is unchanged. G > 0: The pitch P is increased per revolution by the value G. G < 0: The pitch P is decreased per revolution by the value G. If the start and end pitch of the thread are known, the pitch change for programming can be calculated as follows:</p> $G = \frac{ Pe^2 - P^2 }{2 * Z_1} \text{ [mm/U2]}$ <p>This also means: Pe: Final pitch [mm/rev] P: Initial pitch [mm/rev] Z₁: Thread length [mm] A large pitch results in a greater distance between threads on the workpiece.</p>	
Machining	<ul style="list-style-type: none"> • ▽ Roughing • ▽ ▽ Finishing • ▽ + ▽ ▽ (Roughing and finishing) 	
infeed (only for ▽ and ▽ + ▽ ▽)	<ul style="list-style-type: none"> • Linear: infeed with constant cutting depth • Degressive: infeed with constant chip cross-section 	
Thread	Internal thread and external thread	
X0	Reference point X from thread table Ø (absolute).	mm
Z0	Reference point Z (abs)	mm
Z1	End point of the thread (absolute) or thread length (incremental).	mm
LW	Thread run-in (incremental) Thread start point is the preset reference point (X0, Z0) around the thread run-in W. You can use the thread run-in if you want to begin the individual cuts somewhat earlier, in order also to finish the thread start exactly.	mm
or LW2	Thread run-in (incremental) You can use the thread run-in if you cannot approach the thread to be finished from the side, but must penetrate the material (Example: lubrication groove on a shaft).	mm

Parameter	Description	Unit
or LW2 = LR	Thread run-in = thread run-out (incremental)	mm
LR	Thread run-out (incremental) You can use the hthread run-out if you want to move out at an angle at the end of the thread (Example: lubrication groove on a shaft).	mm
H1	Thread depth from thread table (incremental)	mm
DP	Infeed angle as thread (incr.) – (alternatively for infeed angle as angle) DP $\alpha > 0$: Infeed along the rear thread DP $\alpha < 0$: Infeed along the front thread	
or αP	Infeed angle as angle – (alternatively for infeed angle as thread) $\alpha > 0$: Infeed along the rear thread. $\alpha < 0$: Infeed along the front thread. $\alpha = 0$: infeed at right angles to the cutting direction. If infeed along the threads, the absolute value of this parameter must be a maximum of half the tool thread angle.	degrees
	Infeed along the thread	
	Infeed with alternating thread (alternatively) Instead of along a thread, you can also infeed with alternating threads, so as not always to stress the same cutting edge of the tool. In this way, you can increase the working life of the tool. $\alpha > 0$: Start at the rear thread $\alpha < 0$: Start at the front thread	
D1 or ND (only for ▽ and ▽ + ▽ ▽ ▽)	First infeed depth or number of roughing cuts. When switching between the number of roughing cuts and the first infeed, the corresponding value is shown in each case.	mm
U	Finishing allowance in X and Z – (only for ▽ and ▽ + ▽ ▽ ▽).	mm
NN	Number of empty cuts - (only for ▽ ▽ ▽ and ▽ + ▽ ▽ ▽)	
VR	Reverse distance (incremental)	mm

Parameter	Description	Unit
Multi-thread	<ul style="list-style-type: none"> • yes • no 	
$\alpha 0$	Start angle offset	
N	Number of threads The threads are distributed evenly along the rotating part, with the first thread always being placed at 0°.	
DA	Thread change depth (incr.) First machine all threads sequentially to the thread change depth, then machine all threads sequentially to depth 2 · machine DA etc. until the final depth is reached. DA = 0: Thread change depth is not included, i.e. every thread completely before machining the next thread.	
Machining	<ul style="list-style-type: none"> • Complete or • starting from thread N1 N1 (1...4) Start thread N1 = 1...N or <ul style="list-style-type: none"> • only thread NX NX (1...4) 1 from N threads	

Thread table

ISO_METRIC		WHITWORTH_BSW		WHITWORTH_BSP		UNC	
M 1	0,250	W 1/16"	60,000	G 1/16"	28,000	N 1 - 64 UNC	64,000
M 1.2	0,250	W 3/32"	48,000	G 1/8"	28,000	N 2 - 56 UNC	56,000
M 1.6	0,350	W 1/8"	40,000	G 1/4"	19,000	N 3 - 48 UNC	48,000
M 2	0,400	W 5/32"	32,000	G 3/8"	19,000	N 4 - 40 UNC	40,000
M 2.5	0,450	W 3/16"	24,000	G 1/2"	14,000	N 5 - 40 UNC	40,000
M 3	0,500	W 7/32"	24,000	G 5/8"	14,000	N 6 - 32 UNC	32,000
M 3.5	0,600	W 1/4"	20,000	G 3/4"	14,000	N 8 - 32 UNC	32,000
M 4	0,700	W 5/16"	18,000	G 7/8"	14,000	N 10 - 24 UNC	24,000
M 4.5	0,750	W 3/8"	16,000	G 1"	11,000	N 12 - 24 UNC	24,000
M 5	0,800	W 7/16"	14,000	G 1 1/8"	11,000	1/4" - 20 UNC	20,000
M 6	1,000	W 1/2"	12,000	G 1 1/4"	11,000	5/16" - 18 UNC	18,000
M 8	1,250	W 9/16"	12,000	G 1 3/8"	11,000	3/8" - 16 UNC	16,000
M 10	1,500	W 5/8"	11,000	G 1 1/2"	11,000	7/16" - 14 UNC	14,000
M 12	1,750	W 3/4"	10,000	G 1 3/4"	11,000	1/2" - 13 UNC	13,000
M 14	2,000	W 7/8"	9,000	G 2"	11,000	9/16" - 12 UNC	12,000
M 16	2,000	W 1"	8,000	G 2 1/4"	11,000	5/8" - 11 UNC	11,000
M 18	2,500	W 1 1/8"	7,000	G 2 1/2"	11,000	3/4" - 10 UNC	10,000
M 20	2,500	W 1 1/4"	7,000	G 2 3/4"	11,000	7/8" - 9 UNC	9,000
M 22	2,500	W 1 3/8"	6,000	G 3"	11,000	1" - 8 UNC	8,000
M 24	3,000	W 1 1/2"	6,000	G 3 1/4"	11,000	1 1/8" - 7 UNC	7,000
M 27	3,000	W 1 5/8"	5,000	G 3 1/2"	11,000	1 1/4" - 7 UNC	7,000
M 30	3,500	W 1 3/4"	5,000	G 3 3/4"	11,000	1 3/8" - 6 UNC	6,000
M 33	3,500	W 1 7/8"	4,500	G 4"	11,000	1 1/2" - 6 UNC	6,000
M 36	4,000	W 2"	4,500	G 5"	11,000	1 3/4" - 5 UNC	5,000
M 39	4,000	W 2 1/4"	4,000	G 6"	11,000	2" - 4 1/2 UNC	4,500
M 42	4,500	W 2 1/2"	4,000			2 1/4" - 4 1/2 UNC	4,500
M 45	4,500	W 2 3/4"	3,500			2 1/2" - 4 UNC	4,000
M 48	5,000	W 3"	3,500			2 3/4" - 4 UNC	4,000
M 52	5,000	W 3 1/4"	3,250			3" - 4 UNC	4,000
M 56	5,500	W 3 1/2"	3,250			3 1/4" - 4 UNC	4,000
M 60	5,500	W 3 3/4"	3,000			3 1/2" - 4 UNC	4,000
M 64	6,000	W 4"	3,000			3 3/4" - 4 UNC	4,000
M 68	6,000					4" - 4 UNC	4,000

Grooving cycle description

1. The tool moves in rapid traverse to the start-point calculated within the cycle.
2. Thread with advance:
The tool moves in rapid traverse to the first start position placed by the thread advance LW.
Thread with run-in:
The tool moves in rapid traverse to the start position placed by the thread advance LW2.
3. The first cut is finished with pitch P to the thread run-out LR.
4. Thread with advance:
The tool moves in rapid traverse to the withdrawal distance VR and then to the next start position.
Thread with run-in:
The tool moves in rapid traverse to the withdrawal distance VR and again to the start position.
5. Steps 3 to 4 are repeated until the thread is finished completely.
- 6 The tool withdraws in rapid traverse to the retraction plane.

The thread machining can be interrupted at any time with the "Fast lift" function. This guarantees that the tool does not damage the thread during lifting.

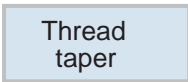

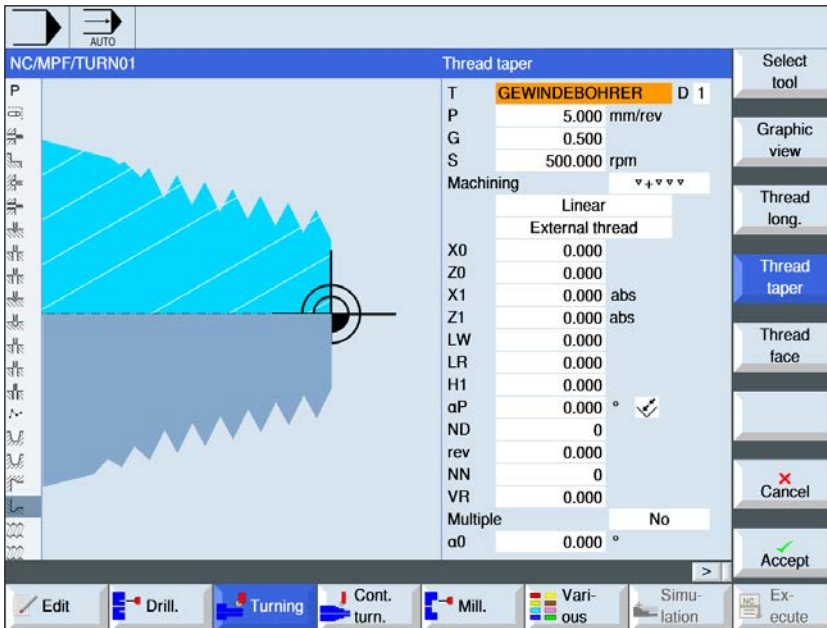

Tapered thread



The "Select" button gives you the option to change parameters and/or units. To do this move the cursor to the appropriate field and press button.

Parameter	Description	Unit
T	Tool name	
D	Cutting number	
P	Selection of pitch/threads for "none" table or details of pitch/threads according to the thread table selection: <ul style="list-style-type: none"> • Pitch in mm/revolution • Pitch in inches/revolution • Threads per inch • Pitch in MODUL. 	Threads/" MODULE mm/rev inches/rev
S / V	Spindle speed or constant cutting speed	rpm m/min

Parameter	Description	Unit
G	<p>Change of pitch per revolution - (only for P = mm/rev or in/rev)</p> <p>G = 0: The pitch P is unchanged. G > 0: The pitch P is increased per revolution by the value G. G < 0: The pitch P is decreased per revolution by the value G. If the start and end pitch of the thread are known, the pitch change for programming can be calculated as follows:</p> $G = \frac{ P_{e^2} - P^2 }{2 * Z_1} \text{ [mm/U2]}$ <p>This also means: Pe: Final pitch [mm/rev] P: Initial pitch [mm/rev] Z₁: Thread length [mm] A large pitch results in a greater distance between threads on the workpiece.</p>	
Machining	<ul style="list-style-type: none"> ▽ Roughing ▽▽ Finishing ▽+▽▽ (Roughing and finishing) 	
Infeed (only for ▽ and ▽+▽▽▽)	<ul style="list-style-type: none"> Linear: infeed with constant cutting depth Degrressive: infeed with constant chip cross-section 	
Thread	Internal thread and external thread	
X0	Reference point X from thread table Ø (absolute).	mm
Z0	Reference point in Z	mm
X1 or X1α	End point X Ø (abs) or end point relative to X0 (incr.) or thread angle Incremental dimension: The symbol is analyzed.	mm or degrees
Z1	End point of the thread (absolute) or thread length (incremental).	mm
LW	Thread run-in (incremental) Thread start point is the preset reference point (X0, Z0) around the thread run-in W. You can use the thread run-in if you want to begin the individual cuts somewhat earlier, in order also to finish the thread start exactly.	mm
or LW2	Thread run-in (incremental) You can use the thread run-in if you cannot approach the thread to be finished from the side, but must penetrate the material (Example: lubrication groove on a shaft).	mm
or LW2 = LR	Thread run-in = thread run-out (incremental)	mm

Parameter	Description	Unit
LR	Thread run-out (incremental) You can use the thread run-out if you want to move out at an angle at the end of the thread (Example: lubrication groove on a shaft).	mm
H1	Thread depth from thread table (incremental)	mm
DP	Infeed angle as thread (incr.) – (alternatively for infeed angle as angle) DP $\alpha > 0$: Infeed along the rear thread DP $\alpha < 0$: Infeed along the front thread	
or αP	Infeed angle as angle – (alternatively for infeed angle as thread) $\alpha > 0$: Infeed along the rear thread. $\alpha < 0$: Infeed along the front thread. $\alpha = 0$: infeed at right angles to the cutting direction. If infeed along the threads, the absolute value of this parameter must be a maximum of half the tool thread angle.	degrees
	Infeed along the thread	
	Infeed with alternating thread (alternatively) Instead of along a thread, you can also infeed with alternating threads, so as not always to stress the same cutting edge of the tool. In this way, you can increase the working life of the tool. $\alpha > 0$: Start at the rear thread $\alpha < 0$: Start at the front thread	
D1 or ND (only for ▽ and ▽+▽▽▽)	First infeed depth or number of roughing cuts. When switching between the number of roughing cuts and the first infeed, the corresponding value is shown in each case.	mm
U	Finishing allowance in X and Z – (only for ▽ and ▽+▽▽▽).	mm
NN	Number of empty cuts - (only for ▽ and ▽+▽▽▽)	
VR	Reverse distance (incremental)	mm

Parameter	Description	Unit
Multi-thread	<ul style="list-style-type: none"> • yes • no 	
$\alpha 0$	Start angle offset	
N	Number of threads The threads are distributed evenly along the rotating part, with the first thread always being placed at 0°.	
DA	Thread change depth (incr.) First machine all threads sequentially to the thread change depth, then machine all threads sequentially to depth 2 · machine DA etc. until the final depth is reached. DA = 0: Thread change depth is not included, i.e. every thread completely before machining the next thread.	
Machining	<ul style="list-style-type: none"> • Complete or • starting from thread N1 N1 (1...4) Start thread N1 = 1...N or <ul style="list-style-type: none"> • only thread NX NX (1...4) 1 from N threads	

Cycle description

- 1 The parts program for machining or ShopTurn program is created and you will find it in the editor.
- 2 Press the "Turn" softkey.
- 3 Press the "Thread" softkey.
- 4 "Tapered thread".
The "Tapered thread input window opens.

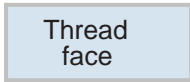

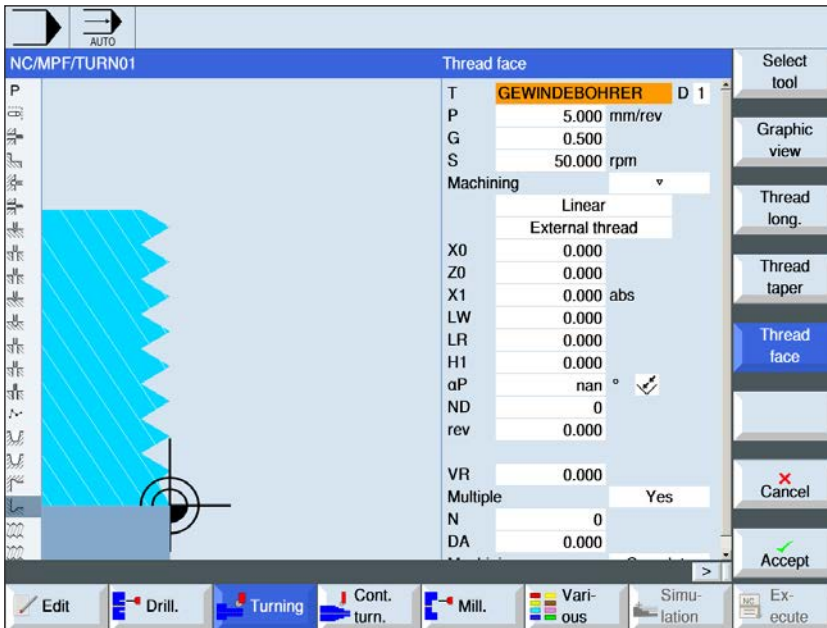

Plane thread



The "Select" button gives you the option to change parameters and/or units. To do this move the cursor to the appropriate field and press button.

Parameter	Description	Unit
T	Tool name	
D	Cutting number	
P	Selection of pitch/threads for "none" table or details of pitch/threads according to the thread table selection: <ul style="list-style-type: none"> • Pitch in mm/revolution • Pitch in inches/revolution • Threads per inch • Pitch in MODUL. 	Threads/" MODULE mm/rev inches/rev
S / V	Spindle speed or constant cutting speed	rpm m/min

Parameter	Description	Unit
G	<p>Change of pitch per revolution - (only for P = mm/rev or in/rev)</p> <p>G = 0: The pitch P is unchanged. G > 0: The pitch P is increased per revolution by the value G. G < 0: The pitch P is decreased per revolution by the value G. If the start and end pitch of the thread are known, the pitch change for programming can be calculated as follows:</p> $G = \frac{ P_e^2 - P^2 }{2 * Z_1} \text{ [mm/U2]}$ <p>This also means: Pe: Final pitch [mm/rev] P: Initial pitch [mm/rev] Z₁: Thread length [mm] A large pitch results in a greater distance between threads on the workpiece.</p>	
Machining	<ul style="list-style-type: none"> ▽ Roughing ▽▽ Finishing ▽+▽▽ ((Roughing and finishing)) 	
Infeed (only for ▽+▽▽)	<ul style="list-style-type: none"> Linear: infeed with constant cutting depth Degressive: infeed with constant chip cross-section 	
Thread	Internal thread and external thread	
X0	Reference point X from thread table Ø (absolute).	mm
Z0	Reference point in Z	mm
Z1	End point of the thread (absolute) or thread length (incremental).	mm
LW	<p>Thread run-in (incremental)</p> <p>Thread start point is the preset reference point (X0, Z0) around the thread run-in W. You can use the thread run-in if you want to begin the individual cuts somewhat earlier, in order also to finish the thread start exactly.</p>	mm
or LW2	<p>Thread run-in (incremental)</p> <p>You can use the thread run-in if you cannot approach the thread to be finished from the side, but must penetrate the material (Example: lubrication groove on a shaft).</p>	mm

Parameter	Description	Unit
or LW2 = LR	Thread run-in = thread run-out (incremental)	mm
LR	Thread run-out (incremental) You can use the thread run-out if you want to move out at an angle at the end of the thread (Example: lubrication groove on a shaft).	mm
H1	Thread depth from thread table (incremental)	mm
DP	Infeed angle as thread (incr.) – (alternatively for infeed angle as angle) DP $\alpha > 0$: Infeed along the rear thread DP $\alpha < 0$: Infeed along the front thread	
or αP	Infeed angle as angle – (alternatively for infeed angle as thread) $\alpha > 0$: Infeed along the rear thread. $\alpha < 0$: Infeed along the front thread. $\alpha = 0$: infeed at right angles to the cutting direction. If infeed along the threads, the absolute value of this parameter must be a maximum of half the tool thread angle.	degrees
	Infeed along the thread	
	Infeed with alternating thread (alternatively) Instead of along a thread, you can also infeed with alternating threads, so as not always to stress the same cutting edge of the tool. In this way, you can increase the working life of the tool. $\alpha > 0$: Start at the rear thread $\alpha < 0$: Start at the front thread	
D1 or ND (only for ▽ and ▽ + ▽ ▽ ▽)	First infeed depth or number of roughing cuts. When switching between the number of roughing cuts and the first infeed, the corresponding value is shown in each case.	mm
U	Finishing allowance in X and Z – (only for ▽ and ▽ + ▽ ▽ ▽).	mm
NN	Number of empty cuts - (only for ▽ ▽ ▽ and ▽ + ▽ ▽ ▽)	
VR	Reverse distance (incremental)	mm

Parameter	Description	Unit
Multi-thread	<ul style="list-style-type: none"> • yes • no 	
$\alpha 0$	Start angle offset	
N	Number of threads The threads are distributed evenly along the rotating part, with the first thread always being placed at 0°.	
DA	Thread change depth (incr.) First machine all threads sequentially to the thread change depth, then machine all threads sequentially to depth 2 · machine DA etc. until the final depth is reached. DA = 0: Thread change depth is not included, i.e. every thread completely before machining the next thread.	
Machining	<ul style="list-style-type: none"> • Complete or • starting from thread N1 N1 (1...4) Start thread N1 = 1...N or <ul style="list-style-type: none"> • only thread NX NX (1...4) 1 from N threads	

Cycle description

1 The parts program for machining or ShopTurn program is created and you will find it in the editor.

2 Press the "Turn" softkey.

3 Press the "Thread" softkey.

4 Press the "Plane thread" softkey.
The "Plane" input window opens.

Turning Cutoff **Grooving**

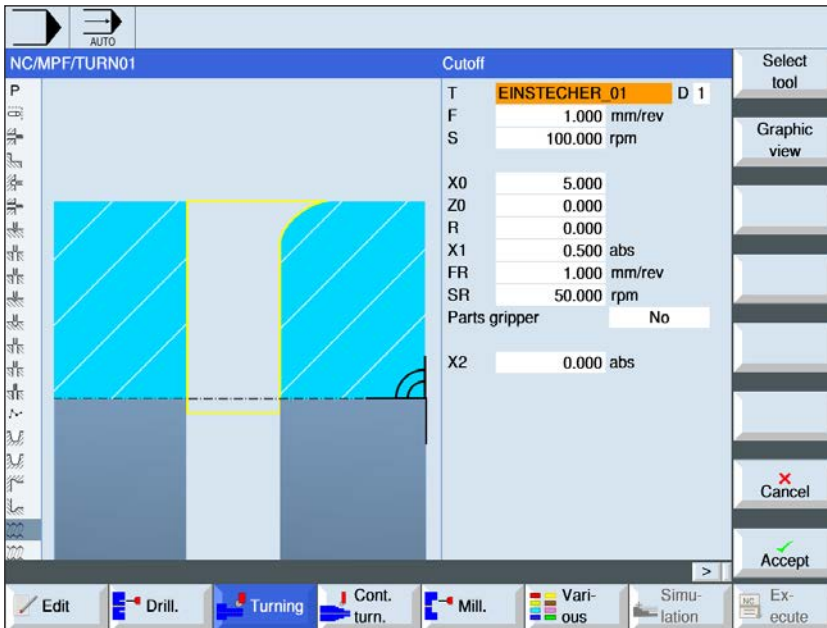

The "Select" button gives you the option to change parameters and/or units. To do this move the cursor to the appropriate field and press button.

Parameter	Description	Unit
T	Tool name	
D	Cutting number	
F	Feed	mm/rev
S / V	Spindle speed or constant cutting speed	rpm m/min
X0	Reference point X from thread table Ø (absolute).	mm
Z0	Reference point in Z	mm
FS or R	Bevel width or rounding radius	mm
X1	Depth for speed reduction Ø (absolute) or depth for speed reduction relative to X0 (incremental)	mm
FR	reduced feed	
SR	reduced speed	
Part catcher	<ul style="list-style-type: none"> • yes • no 	
XM	Move out to parts catcher depth	mm
X2	Final depth Ø (absolute) or final depth relative to X1 (incremental)	

Grooving cycle description

1. The tool moves in rapid traverse only to the startpoint calculated within the cycle.
2. The bevel or radius is finished with the machining feed.
3. The groove is made with machining feed up to depth X1.
4. The feed is continued with reduced feed FR and reduced speed SR to depth X2.
- 5 The tool withdraws to the safety distance in rapid traverse.

if the lathe is fitted appropriately, you can move out a workpiece housing (parts catcher) which accepts the grooved workpiece. The moving out of the workpiece housing must be approved in a machine datum.

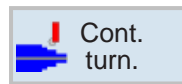

Contour turning

- New contour
- Machining
- Grooving
- Groove turning

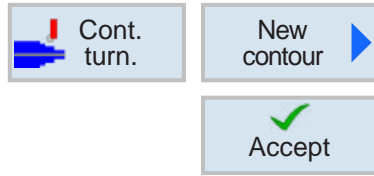

Create new contour

- Enter contour name and confirm with softkey. If the program name exists already, an error machine pops up with a prompt to enter a new name.

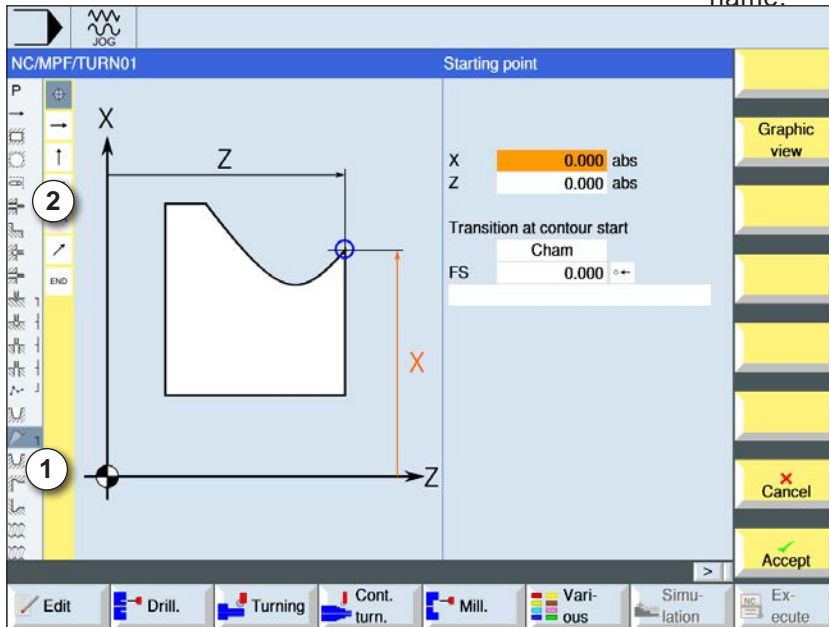

Instructions:
 The individual contour elements of a contour will be shown symbolically in the indicated sequence on the left alongside the graphic window (2).
 On the far left the individual cycles of a program are symbolically represented in the indicated sequence (1).

- 1 Cycle symbols
- 2 Contour element

- Then the start point of the contour will be entered.
- If applicable, enter additional commands in the form of G-Code.
- Press softkey to apply the cycle in the workpiece program.
- Enter individual contour elements and apply with softkey:

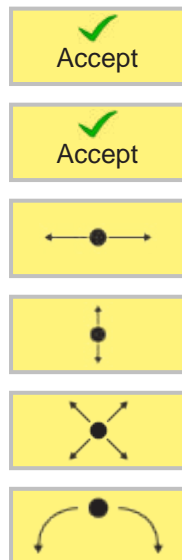

- Straight line element in Z
- Straight line element in X
- Straight line element in ZX
- Circular element



Contour element straight line Z

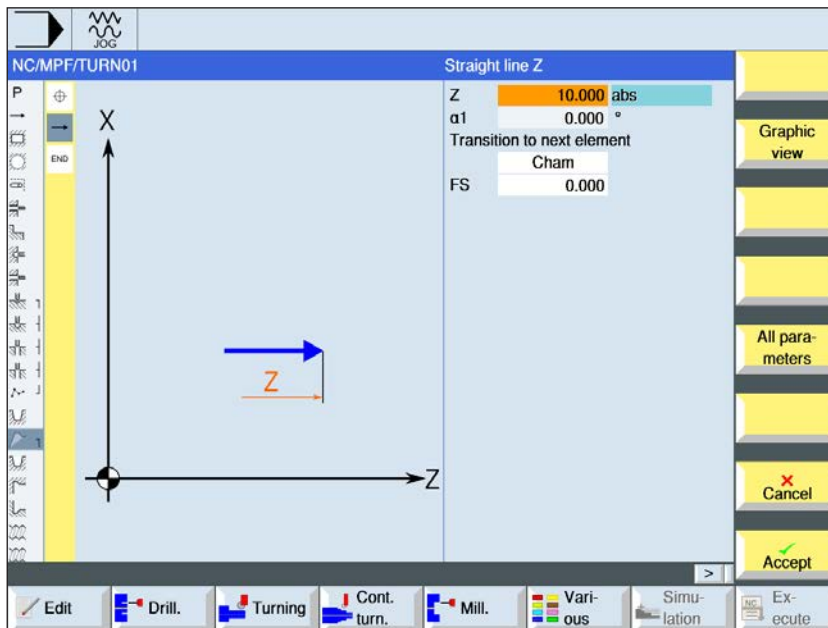

The "Select" button gives you the option to change parameters and/or units. To do this move the cursor to the appropriate field and press button.

Parameter	Description	Unit
Z	End point Z (absolute or incremental)	mm
$\alpha 1$	Start angle e.g. to Z-axis	degrees
$\alpha 2$	Angle to previous element	degrees
Transition to succeeding element	Type of transition <ul style="list-style-type: none"> • Radius • Bevel 	
R	Transition to succeeding element - Radius	mm
FS	Transition to succeeding element - Bevel	mm
Additional commands	Additional G-code commands	



Contour element straight line X

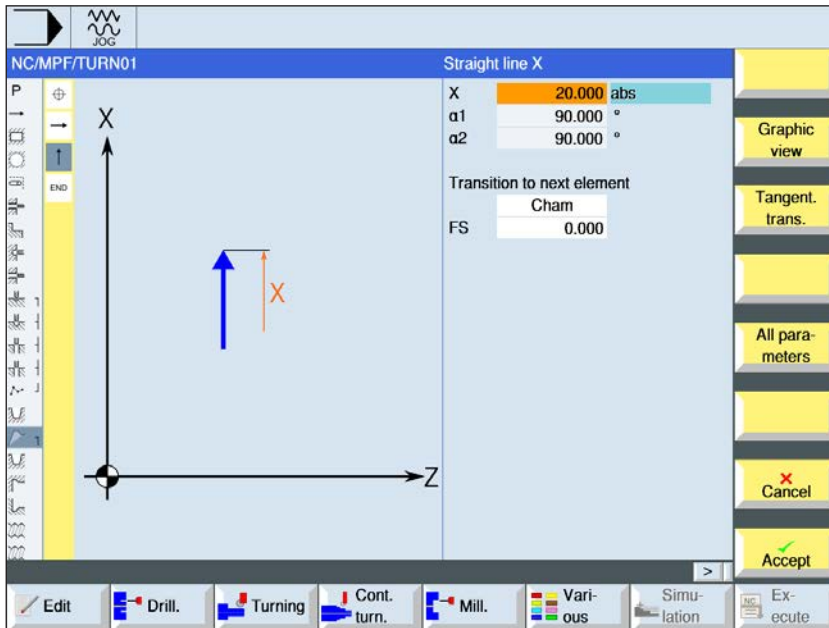

The "Select" button gives you the option to change parameters and/or units. To do this move the cursor to the appropriate field and press button.

Parameter	Description	Unit
X	End point X Ø (abs) or end point X (incr.)	mm
$\alpha 1$	Start angle e.g. to Z-axis	degrees
$\alpha 2$	Angle to previous element	degrees
Transition to succeeding element	Type of transition • Radius • Bevel	
R	Transition to succeeding element - Radius	mm
FS	Transition to succeeding element - Bevel	mm
Additional commands	Additional G-code commands	



Contour element straight line ZX

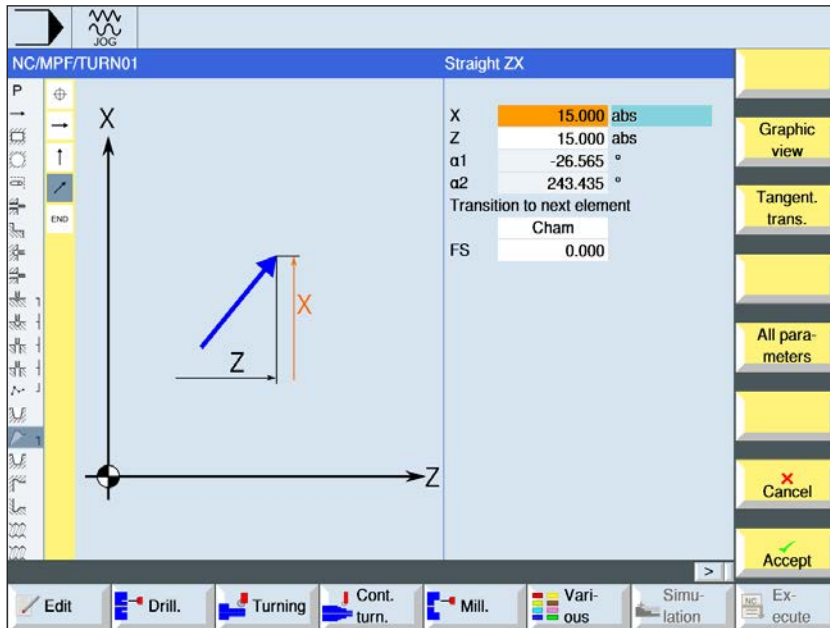

The "Select" button gives you the option to change parameters and/or units. To do this move the cursor to the appropriate field and press button.

Parameter	Description	Unit
Z	End point Z (absolute or incremental)	mm
X	End point X Ø (abs) or end point X (incr.)	mm
L	Length	mm
$\alpha 1$	Start angle e.g. to Z-axis	degrees
$\alpha 2$	Angle to previous element	degrees
Transition to succeeding element	Type of transition <ul style="list-style-type: none"> • Radius • Bevel 	
R	Transition to succeeding element - Radius	mm
FS	Transition to succeeding element - Bevel	mm
Additional commands	Additional G-code commands	



Contour element circle



The "Select" button gives you the option to change parameters and/or units. To do this move the cursor to the appropriate field and press button.

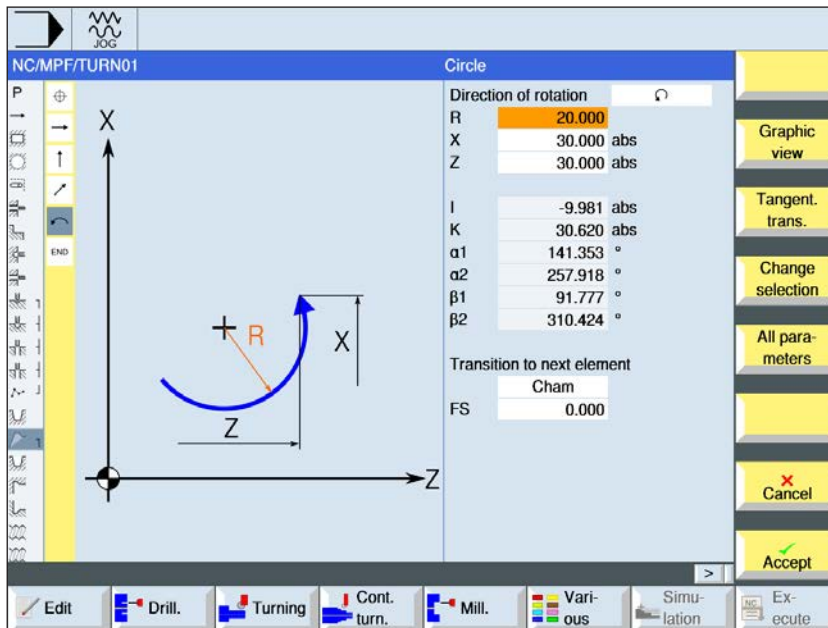

Parameter	Description	Unit
Direction of rotation	<ul style="list-style-type: none"> Direction of rotation right Direction of rotation left 	
Z	End point Z (absolute or incremental)	mm
X	End point X Ø (absolute) or end point X (incremental)	mm
K	Circle center K (absolute or incremental)	mm
I	Circle center I Ø (absolute or circle center I (incremental)	mm
α1	Start angle to Z-axis	degrees
α2	Angle to previous element	degrees
β1	End angle to Z-axis	degrees
β2	Opening angle	degrees
Transition to succeeding element	Type of transition <ul style="list-style-type: none"> • Radius • Bevel 	
R	Transition to succeeding element - Radius	mm
FS	Transition to succeeding element - Bevel	mm
Additional commands	Additional G-code commands	

Other functions:	
Graphic view	<ul style="list-style-type: none">• Change view This softkey switches between the graphics window and the input screen.
Tangent. trans.	<ul style="list-style-type: none">• Tangent to previous element Program the transition to the previous element as a tangent.
Dialog select	<ul style="list-style-type: none">• Dialog selection If two different contour options result from previously entered parameters, one of them must be selected.
Dialog accept	<p>Apply the selection contour option with the softkey.</p>
Change selection	<ul style="list-style-type: none">• change dialog concerned When a dialogue selection has already been made this softkey changes the selected solution again.
all parameters	<ul style="list-style-type: none">• Show additional parameters If additional parameters should be shown for individual contour elements, e.g. to enter additional commands.
Close contour	<ul style="list-style-type: none">• Close contour The contour will be closed from the current position with a straight line to the start point.

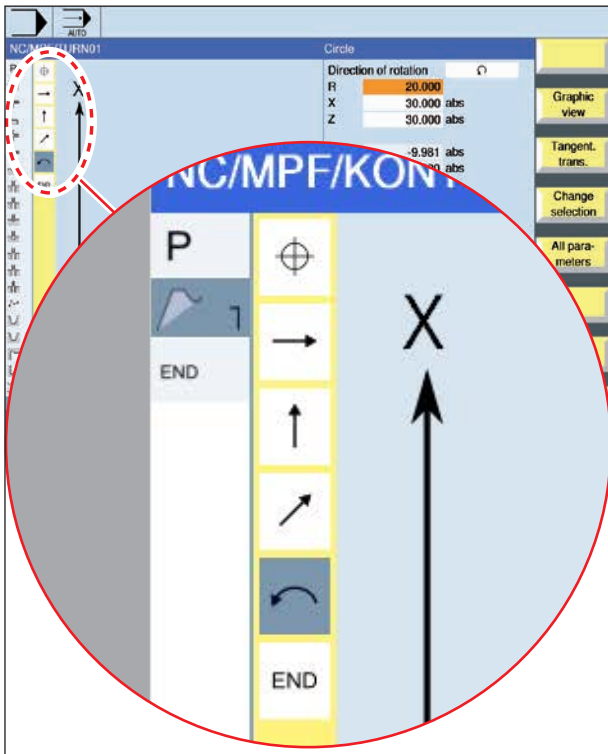

Symbol representation of the contour elements:

Contour element	Symbol	Meaning
Start point		Start point of the contour
Straight up Straight down		Straight line in 90° grid
Straight left Straight right		Straight line in 90° grid
Straight line anywhere		Straight line with arbitrary pitch
Curve right Curve left		Circle
Contour termination	END	End of the contour description

The contour element can accept different line types and colours:

- Black: Programmed contour
- Orange: Current contour element
- Line-dot-dot: Partially-defined element

The scaling of the coordinate system adapts to the change of the entire contour.

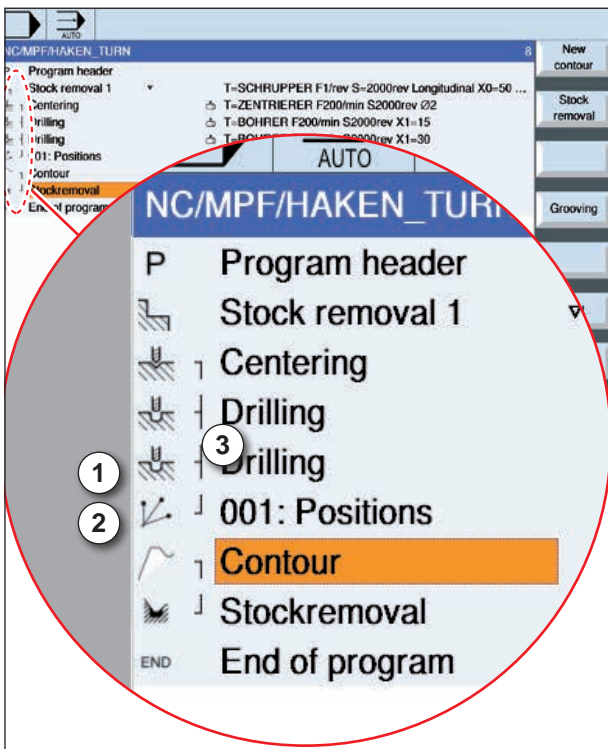

Link representation of contour elements with contour cycles:

A complete contour cycle consists of the associated contour (1) and the processing cycle (2). The programming sequence must be observed: The contour will be created first and the processing cycle afterwards (e.g.: path milling). The control system links both program parts with a symbolic bracket (3) in the cycle list.

Change contour

Change contour element

- Open the program to be machined.
- Use the cursor to select the program block in which the contour should be changed. The individual contour elements will be listed.
- Position cursor at the point to insert or change.
- Use the softkey to select the desired element.
- Enter parameter in the input screen or delete the element and select a new element.
- Press Softkey. The desired contour element will be inserted or changed on the contour.



Change
selection

✓
Accept

Delete contour element

- Open the program to be machined.
- Position cursor on the contour element that should be deleted.
- Press Softkey.
- Press Softkey.

Delete
element

✓
Delete



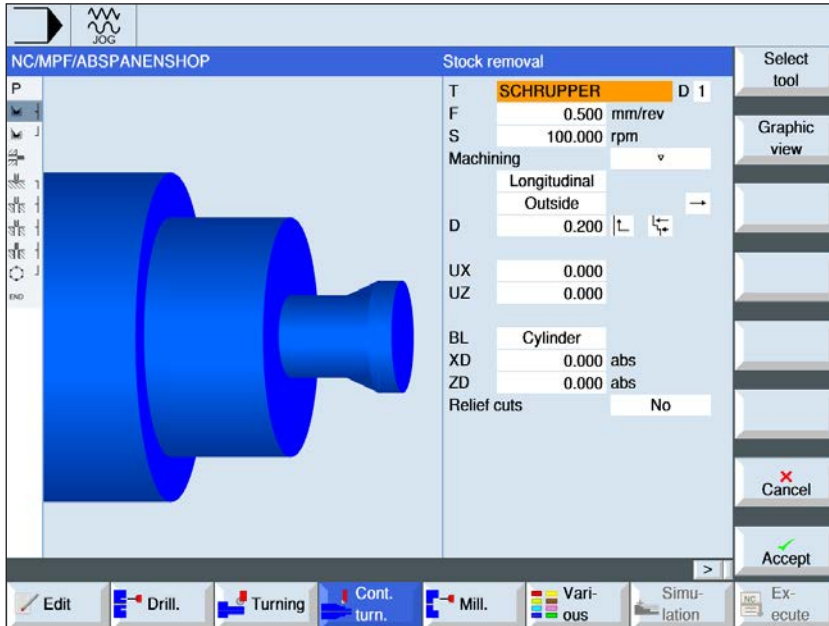

Machining



The "Select" button gives you the option to change parameters and/or units. To do this move the cursor to the appropriate field and press button.

Parameter	Description	Unit
T	Tool name	
D	Cutting number	
F	Feed	mm/rev
S / V	Spindle speed or constant cutting speed	rpm m/min
Machining	<ul style="list-style-type: none"> ▾ Roughing ▾ ▾ ▾ Finishing 	
Machining direction	<ul style="list-style-type: none"> • Plane • Longitudinally <p>The processing direction is dependent on the machining direction or choice of tool.</p>	

Parameter	Description	Unit
Position	<ul style="list-style-type: none"> • in front • behind • internal (for machining direction parallel to the contour) • external (for machining direction parallel to the contour) 	
D	maximum infeed depth – (only for ▽)	mm
	<ul style="list-style-type: none"> • always track at the contour 	
	<ul style="list-style-type: none"> • Cut division even 	
	<ul style="list-style-type: none"> • constant cut depth 	
UX or U	Finishing pass in X or finishing pass in X and Z – (only for ▽)	mm
UZ	Finishing pass in Z – (only for UX)	mm
DI	For zero: continuous cut - (only for ▽)	mm
BL	Unmachined part description <ul style="list-style-type: none"> • Cylinder 	
XD	(only for unmachined part description cylinder) <ul style="list-style-type: none"> • For unmachined part description cylinder <ul style="list-style-type: none"> - Allowance or cylinder dimension Ø (abs) - Allowance or cylinder dimension (incr.) 	mm
ZD	(only for unmachined part description cylinder) <ul style="list-style-type: none"> • For unmachined part description cylinder <ul style="list-style-type: none"> Allowance or cylinder dimension (absolute or incremental) 	mm
Allowance	Allowance for preliminary finishing - (only for ▽ ▽ ▽) <ul style="list-style-type: none"> • yes <ul style="list-style-type: none"> U1 contour allowance • no 	
U1	Correction allowance in X and Z directions (incremental) – (only for allowance) <ul style="list-style-type: none"> • positive value: Correction allowance is unchanged • negative value: Correction allowance is also removed for finishing allowance 	mm
Rear cuts	Machine rear cuts <ul style="list-style-type: none"> • yes • no 	
FR	Rear cuts entry feed	

Tracking the contour

To prevent residual corners remaining when roughing, select "Always track at the contour". This removes the noses that are left with every cut at the end (owing to the cutting geometry) on the contour. The setting "Track as far as the previous cutting point" speeds up the machining of the contour. However, residual corners are not detected and machined. It is therefore essential that you check the pattern before machining using simulation.

Alternating cut depth

So as not to stress the cutting tool constantly, you can also work with alternating cut depth instead of constant cut depth D. This can increase the working life of the tool. The percentage for alternating cut depth is set in a machine datum.

Cut division

If you want to avoid very thin cuts occurring through contour edges with cut division, you can align cut division to the contour edges. With this machining, the contour is then divided by the edges into individual cuts and the cut is divided for each cut separately.

Limit machining area

If you want to machine a given area of the contour with another tool, the machining area can be limited so that only the wanted part of the contour is machined. Between 1 and 4 limit lines can be

defined.

Feed interruption

If you want to prevent excessively large chios while machining, a feed interruption can be programmed. The parameter DI gives the path after which the feed should be interrupted.



Grooving

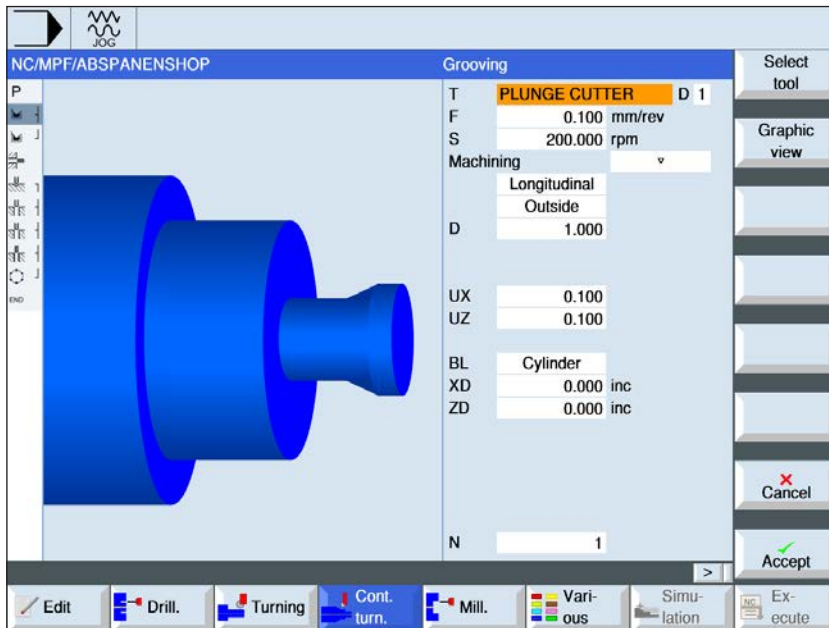

The "Select" button gives you the option to change parameters and/or units. To do this move the cursor to the appropriate field and press button.

Parameter	Description	Unit
T	Tool name	
D	Cutting number	
F	Feed	mm/rev
S / V	Spindle speed or constant cutting speed	rpm m/min
Machining	<ul style="list-style-type: none"> ▾ Roughing ▾ ▾ ▾ Finishing 	
Machining direction	alternating machining direction <ul style="list-style-type: none"> • transverse • longitudinally 	
Position	<ul style="list-style-type: none"> • in front (for transverse machining direction) • behind (for transverse machining direction) • external (for machining direction longitudinally) • internal (for machining direction longitudinally) 	
D	Maximum infeed depth (only for ▾ roughing)	mm
XDA	1. Grooving limit tool (abs) – (only for transverse machining direction)	mm
XDB	2. Grooving limit tool (abs) – (only for transverse machining direction)	mm
UX or U	Finishing pass in X or finishing pass in X and Z – (only for ▾ roughing)	mm

Parameter	Description	Unit
UZ	Finishing pass in Z – (only for UX)	mm
BL	Unmachined part description <ul style="list-style-type: none"> • Cylinder • Allowance • Contour 	
XD	only for unmachined part description cylinder <ul style="list-style-type: none"> • For unmachined part description cylinder Allowance or cylinder dimension Ø (abs) Allowance or cylinder dimension (incr.) 	mm
ZD	only for unmachined part description cylinder <ul style="list-style-type: none"> • For unmachined part description cylinder Allowance or cylinder dimension (absolute or incremental) 	mm
Allowance	Pass for preliminary finishing - (only for ▽ ▽ ▽ finishing) <ul style="list-style-type: none"> • yes U1 contour allowance • no 	mm
U1	Correction allowance in X and Z directions (incremental) – (only for allowance) <ul style="list-style-type: none"> • positive value: Correction allowance is unchanged • negative value: orrection allowance is also removed for finishing allowance 	mm
N	Number of grooves	
DP	Groove spacing (incr.)	mm

Before the groove is programmed, its contour must first be entered.

If the groove is wider than the active tool, the width will be machined in several steps. The tool will also be offset in every groove by a (maximum) 80% of the tool width.

When grooving, the cycle takes into account an unmachined part that can be from a cylinder, a pass on the finished part contour or any unmachined part contour.

For more information on grooving, see "Machining" cycle.

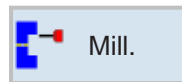

Milling

- Pocket
- Spigot
- Multiple edge
- Slot
- Thread milling
- Engraving
- Contour milling

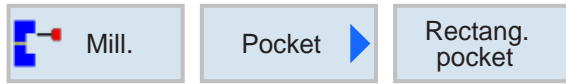

Rectangular pocket

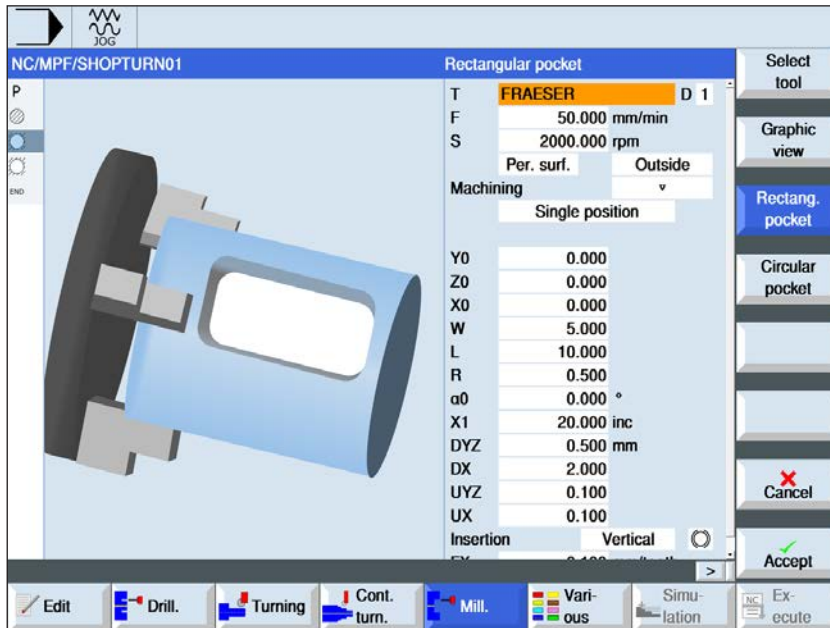

The "Select" button gives you the option to change parameters and/or units. To do this move the cursor to the appropriate field and press button.

Parameter	Description	Unit
T	Tool name	
D	Cutting number	
F	Feed	mm/min mm/tooth
S / V	Spindle speed or constant cutting speed	rpm m/min
Machining surface	<ul style="list-style-type: none"> • Front • Side <p>Note that clamping for machining in the front and side planes remains active only for the drilling process.</p>	
Position	<ul style="list-style-type: none"> • in front • behind 	
Machining	<ul style="list-style-type: none"> • ▾ Roughing • ▾ ▾ Finishing • ▾ ▾ ▾ Edge finishing • Chamfering 	
Machining position	<ul style="list-style-type: none"> • Position template Mill rectangular pocket at the programmed position (X0, Y0, Z0). • Individual position Position with MCALL 	
X0 or L0 Y0 or C0 Z0	Front: The positions are relative to the reference point: Reference points X, Y, Z – (only for individual position)	mm mm or degrees mm

Parameter	Description	Unit
Y0 or C0 Z0 X0	Side: The positions are relative to the reference point: Reference point Y or reference point polar angle – (only for individual position) Reference point Z – (only for individual position) Cylinder diameter \varnothing – (only for individual position)	mm or degrees mm mm
W	Width of the pocket	mm
L	Length of the pocket	mm
R	Corner radius	mm
$\alpha 0$	Angle	degrees
X1 or Z1	Depth relative to Z0 (incremental) or pocket depth (absolute) (only if ∇ , $\nabla \nabla \nabla$ or $\nabla \nabla \nabla$ Edge) Z1 for front machining surface and X1 for side	mm
DX or DYZ	<ul style="list-style-type: none"> • maximum plane infeed • Plane infeed %, as a proportion of the plane infeed (mm) to the mill diameter (mm); (only if ∇ or $\nabla \nabla \nabla$; only for area machining of the front DX for front machining surface and DYZ for side	mm %
DX or DZ	Maximum depth infeed (only if ∇ , $\nabla \nabla \nabla$ or $\nabla \nabla \nabla$ edge) DZ for front machining surface and DX for side	mm
UXY or UYZ	Finishing pass plane (only if ∇ , $\nabla \nabla \nabla$ or $\nabla \nabla \nabla$ edge) UXY for front machining surface and UYZ for side	mm
UX or UZ	Finishing pass depth (only if ∇ or $\nabla \nabla \nabla$) UZ for front surface machining and UX for side	mm
Plunge mode	<p>(only if ∇ or $\nabla \nabla \nabla$)</p> <ul style="list-style-type: none"> • vertical: Plunge vertically on pocket center The calculated current infeed depth will be executed in the pocket center in one block. The milling cutting tool must cut via the center or it must be pre-drilled. • helical: Plunging on spiral path The center of the milling cutter moves on the spiral path defined by the radius and the depth per revolution (helical path). Once the depth for the infeed has been reached, another full circle will be executed, in order to overcome the angular path of the plunge. • swinging: Plunge swinging on center axis of the rectangular pocket axis The center of the milling cutter swings on a straight line back and forth till the depth infeed is reached. Once the depth has been reached, the path will be executed again without the infeed, in order to overcome the angular path of the plunge. 	
FZ	Infeed depth (only when vertical) FZ for front machining surface or FX for side	mm/min mm/tooth
EP	Maximum pitch of the helix (only with helical plunging)	mm/rev
ER	Radius of the helix (only with helical plunging) The radius may not be larger than the milling cutting tool radius, as otherwise material remains.	mm

Parameter	Description	Unit
EW	Maximum plunge angle (only with swinging plunging)	degrees
FS	Bevel width for chamfering - (only for chamfering)	mm
ZFS or XFS	Tool tip plunge depth (absolute or incremental) (only for chamfering) ZFS for front machining surface or XFS for side	mm

Cycle description

- 1** The control system positions the tool in rapid traverse (G0) at the retract plane height on the rectangular pocket center point and at the safety distance.
- 2** The tool mills into the material according to the selected strategy.
- 3a** Machining ▾ Roughing
During roughing the machining will be from the center out of the individual planes of the rectangular pocket until the depth Z1 is reached.
- 3b** Machining ▾ ▾ Finishing
During finishing the edge will always be processed first. In the process the rectangular pocket edge will be approached in the quarter circle in which it joins the corner radius. In the last infeed the bottom will be finished from the center.
- 3c** Machining ▾ ▾ Edge finishing
Edge finishing takes place as with finishing. Only the last infeed (bottom finishing) is absent.
- 3d** Machining chamfering
During chamfering the edge on the top of the rectangular pocket will be breached.
- 4** The rectangular pocket is always machined from inwards to outwards with the selected machining type.
- 5** The tool moves back to the safety distance in rapid traverse (G0).

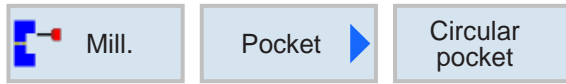

Circular pocket



The "Select" button gives you the option to change parameters and/or units. To do this move the cursor to the appropriate field and press button.

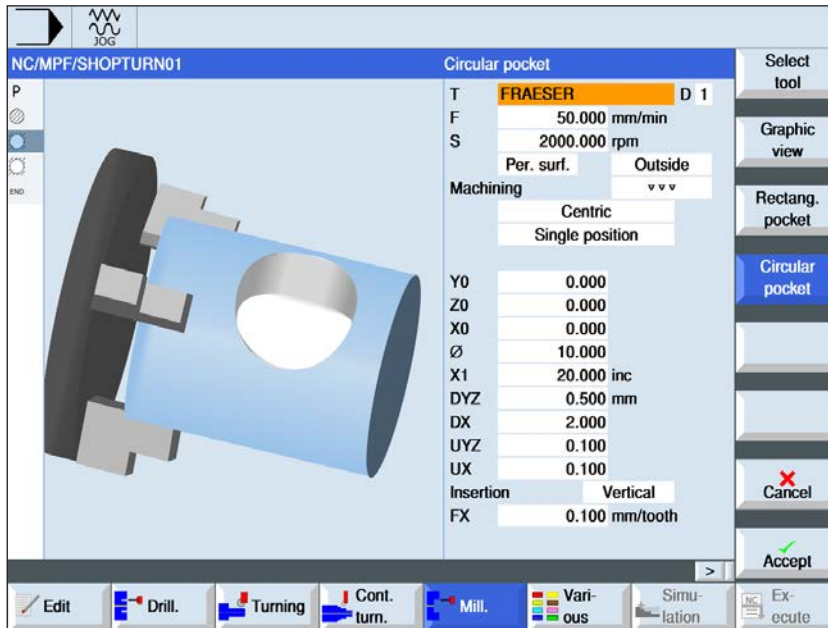

Parameter	Description	Unit
T	Tool name	
D	Cutting number	
F	Feed	mm/min mm/rev
S / V	Spindle speed or constant cutting speed	rpm m/min
Machining surface	<ul style="list-style-type: none"> • Front • Side <p>Note that clamping for machining in the front and side planes remains active only for the drilling process.</p>	
Position	<ul style="list-style-type: none"> • in front (front machining surface) • rear (front machining surface) • internal (side machining surface) • external (side machining surface) 	
Machining	<ul style="list-style-type: none"> • ▾ Roughing • ▾ ▾ Finishing • ▾ ▾ ▾ Edge finishing • Chamfering 	
Machining type	<ul style="list-style-type: none"> • planar Planar machining of circular pocket • helical Helical machining of circular pocket 	
M a c h i n i n g position	<ul style="list-style-type: none"> • Individual position A circular pocket will be milled at the programmed position (X0, Y0, Z0). • Position template Several circular pockets will be milled on a position template (e.g. full circle, partial circle, grid, etc.). 	

Parameter	Description	Unit
X0 or L0 Y0 or C0 Z0	Front: The positions are relative to the reference point: Reference points X, Y, Z – (only for individual position)	mm mm or degrees mm
Y0 or C0 Z0 X0	Side: The positions are relative to the reference point: Reference point Y or reference point polar angle – (only for individual position) Reference point Z – (only for individual position) Cylinder diameterØ – (only for individual position)	mm or degrees mm mm
Ø	Diameter of the pocket	mm
X1 or Z1	Depth relative to Z0 (incremental) or pocket depth (absolute) (only if ▽, ▽ ▽ ▽ or ▽ ▽ ▽ Edge) Z1 for front machining surface and X1 for side	mm
DXY or DYZ	<ul style="list-style-type: none"> • maximum plane infeed • maximum plane infeed as a percentage of the mill diameter (only if ▽ or ▽ ▽ ▽) DXY for front machining surface and DYZ for side	mm %
DZ or DX	Maximum depth infeed (only if ▽, ▽ ▽ ▽ or ▽ ▽ ▽ edge) DZ for front machining surface and DX for side	mm
UXY or UYZ	Finishing pass plane (only if ▽, ▽ ▽ ▽ or ▽ ▽ ▽ edge) UXY for front machining surface and UYZ for side	mm
UZ or UX	Finishing pass depth (only if ▽, ▽ ▽ ▽ or ▽ ▽ ▽ edge) UZ for front surface machining and UX for side	mm
Plunging	(only if "planar", ▽, ▽ ▽ ▽ or ▽ ▽ ▽ edge) <ul style="list-style-type: none"> • vertical: Plunge vertically on pocket center The calculated infeed depth will be executed vertically in the pocket center. Feed: Infeed as programmed under FZ. When plunging vertically on the pocket center the milling cutting tool must cut via the center or it must be pre-drilled. • helical: Plunging on spiral path The center of the mill moves with the machining feed on the spiral path defined by the radius and the depth per revolution (helical path). Once the depth for the infeed has been reached, another full circle will be executed, in order to overcome the angular path of the plunge. 	
FZ or FX	Infeed depth (only when vertical) FZ for front machining surface or FX for side	mm/min mm/tooth
EP	Maximum pitch of the helix (only with helical plunging)	mm/rev
ER	Radius of the helix (only with helical plunging) The radius may not be larger than the milling cutting tool radius, as otherwise material remains.	mm
FS	Bevel width for chamfering (only for chamfering)	mm
ZFS or XFS	Tool tip plunge depth (absolute or incremental) (only for chamfering) ZFS for front machining surface or XFS for side	mm

Cycle description**Planar plunge mode**

- 1 The control system positions the tool in rapid traverse (G0) at the retract plane height on the elbow pocket center point and at the safety distance.
- 2 The tool mills into the material according to the selected strategy.
- 3a Machining ▾ Roughing
During roughing the machining will be from the centre out of the individual planes of the circular pocket until the depth Z1 is reached.
- 3b Machining ▾ ▾ ▾ Finishing
During finishing the edge will always be processed first. In the process the pocket edge will be approached in the quarter circle in which it joins the corner radius. In the last infeed the bottom will be finished from the center.
- 3c Machining ▾ ▾ ▾ Edge finishing
Edge finishing is performed like the finishing. The last infeed (bottom finishing) is not applicable.
- 4 The machining of the circular pocket always takes place from inwards to outwards with the selected machining type. The material will be cleared away ("by plane").
- 5 The tool moves back to the safety distance in rapid traverse (G0).

Cycle description**Helical plunge mode**

- 1 The control system positions the tool in rapid traverse (G0) at the retract plane height on the elbow pocket center point and at the safety distance.
- 2 The tool feeds in to the first machining diameter and mills into the material according to the selected strategy.
- 3a Machining ▾ Roughing
During roughing the circular pocket will be processed with top-down helical movements. A full circle will be executed at the pocket depth to remove the remaining material. The tool will be moved freely from the pocket edge and bottom in the quadrant and pulled back to the safety distance in rapid traverse. This sequence repeats in a shell-like way from inside to outside, until the circular pocket is fully processed.
- 3b Machining ▾ ▾ ▾ Finishing
When finishing the edge will be processed first with a helical movement to the bottom. A full circle will be executed at the pocket depth to remove the remaining material. The bottom will be milled out in a spiral shape from outside to inside. From the pocket centre there will be a pull-back in rapid traverse to the safety distance.
- 3c Machining ▾ ▾ ▾ Edge finishing
When finishing the edge will be processed first with a helical movement to the bottom. A full circle will be executed at the pocket depth to remove the remaining material. The tool will be moved freely from the pocket edge and bottom in the quadrant and pulled back to the safety distance in rapid traverse.
- 4 The machining of the circular pocket takes place with the selected machining type to the pocket depth or to the pocket depth with finishing pass.
- 5 The tool moves back to the safety distance in rapid traverse (G0).

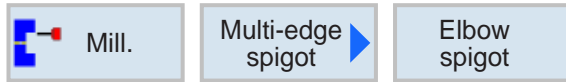

Elbow spigot



The "Select" button gives you the option to change parameters and/or units. To do this move the cursor to the appropriate field and press button.

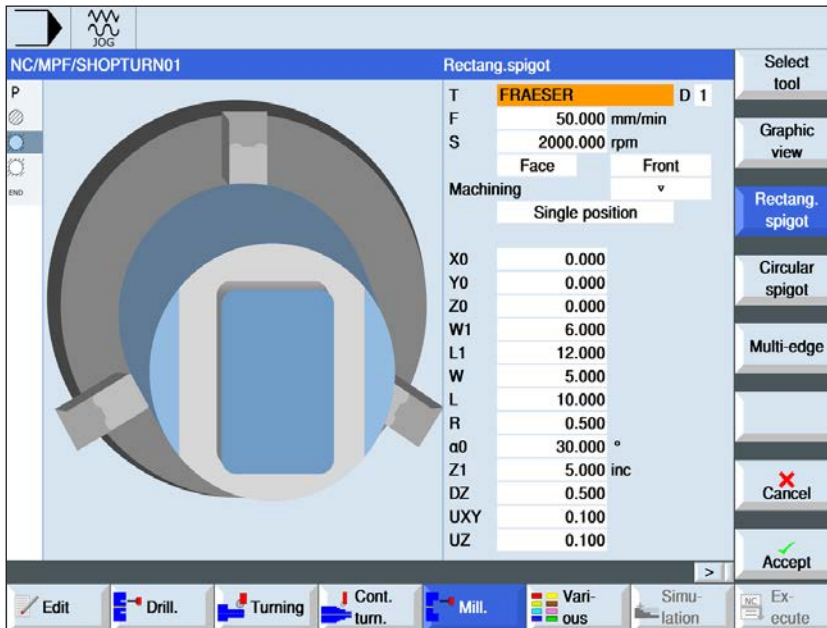

Parameter	Description	Unit
T	Tool name	
D	Cutting number	
F	Feed	mm/min mm/tooth
S / V	Spindle speed or constant cutting speed	rpm m/min
Position	<ul style="list-style-type: none"> • in front • behind 	
Reference point	<ul style="list-style-type: none"> • (center) • (bottom left) • (bottom right) • (top left) • (top right) 	
Machining	<ul style="list-style-type: none"> • ▾ Roughing • ▾ ▾ Finishing • Chamfering 	
Machining position	<ul style="list-style-type: none"> • Individual position Mill elbow pocket at the programmed position (X0, Y0, Z0). • Position template Mill elbow spigot on a position template. 	

Parameter	Description	Unit
X0 Y0 Z0	The positions are relative to the reference point: (only for "single position") Reference point in X, Y and Z	mm
W	Spigot width (only if chamfering)	mm
L	Spigot width (only if chamfering)	mm
R	Corner radius	mm
$\alpha 0$	Angle	degrees
Z1	Slot depth (absolute) or depth relative to Z0 (incremental) (only if ▽ or ▽ ▽ ▽)	mm
DZ	maximum depth infeed (only if ▽ or ▽ ▽ ▽)	mm
UXY	Finishing pass plane at the length (L) of the circular spigot and the width (W) of the circular spigot. Smaller circular spigot dimensions will be achieved by calling the cycle again and programming it with reduced finishing pass. (only if ▽ or ▽ ▽ ▽)	mm
UZ	Finishing pass depth (only if ▽ or ▽ ▽ ▽)	mm
W1	Width of the unmachined part of the spigot (only if ▽ or ▽ ▽ ▽)	mm
L1	Length of the unmachined part of the spigot (only if ▽ or ▽ ▽ ▽)	mm
FS	Bevel width for chamfering (only for chamfering)	mm
ZFS	Tool tip plunge depth (only when chamfering)	mm

Cycle description

- 1 The control system positions the tool in rapid traverse (G0) at the retract plane height and at the safety distance. The start point lies on the positive X-axis rotated by $\alpha 0$.

During chamfering the edge on the top of the elbow spigot will be breached.
- 2 The tool approaches the spigot contour in the semi-circle with machining feed. First the infeed to the machining depth takes place, then the movement in the plane. The elbow spigot will be processed in the clockwise or counter-clockwise direction according to the programmed direction of rotation for machining (up-cut milling/down-cut milling).
 - 4 Once the elbow spigot has been bypassed once, the tool leaves the contour in the semi-circle and the infeed to the next machining plane takes place.
 - 5 The elbow spigot will again be approached in the semi-circle and bypassed once. This will be repeated until the programmed spigot depth is reached.
 - 6 The tool moves back to the safety distance in rapid traverse (G0).
- 3a Machining ▽ Roughing
When roughing the elbow spigot will be bypassed, until the programmed finishing pass is reached.
- 3b Machining ▽ ▽ ▽ Finishing
During finishing the elbow spigot will be bypassed, until depth Z1 is reached.
- 3c Machining - chamfering

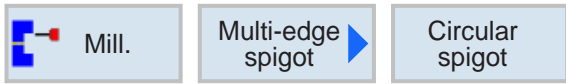

Circular spigot

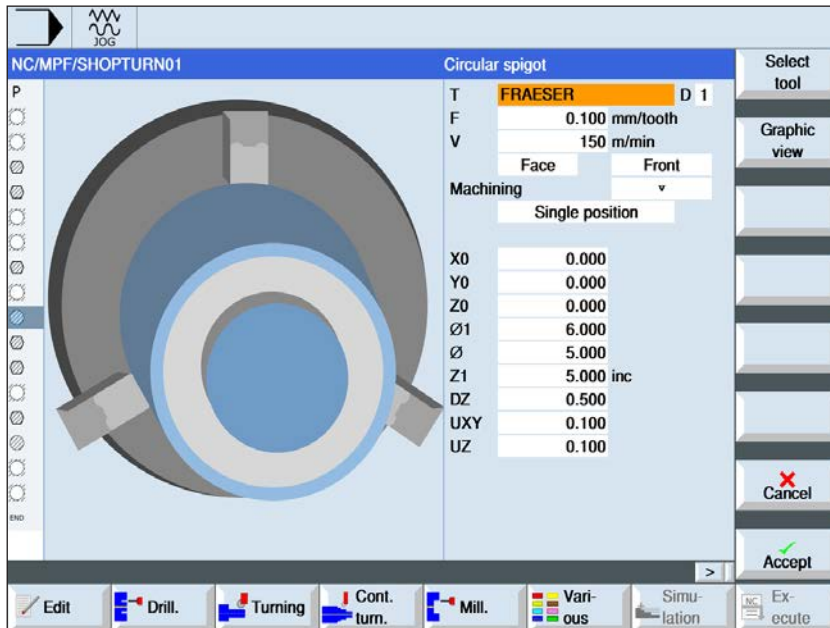

The "Select" button gives you the option to change parameters and/or units. To do this move the cursor to the appropriate field and press button.

Parameter	Description	Unit
T	Tool name	
D	Cutting number	
F	Feed	mm/min mm/tooth
S / V	Spindle speed or constant cutting speed	rpm m/min
Position	<ul style="list-style-type: none"> • in front • behind 	
Machining	<ul style="list-style-type: none"> • ▾ Roughing • ▾ ▾ Finishing • Chamfering 	
Machining position	<ul style="list-style-type: none"> • Individual position Mill circular spigot at the programmed position (X0, Y0, Z0). • Position template Mill circular spigot on a position template. 	
X0 Y0 Z0	The positions are relative to the reference point: (only for "single position") Reference point in X, Y and Z	mm
Ø	Spigot diameter	mm
Z1	Slot depth (absolute) or depth relative to Z0 (incremental) (only if ▾ or ▾ ▾ ▾)	mm

Parameter	Description	Unit
DZ	maximum depth infeed (only if ▽ or ▽ ▽ ▽)	mm
UXY	Finishing pass plane at the length (L) of the circular spigot and the width (W) of the circular spigot. Smaller circular spigot dimensions will be achieved by calling the cycle again and programming it with reduced finishing pass. (only if ▽ or ▽ ▽ ▽)	mm
UZ	Finishing pass depth (only if ▽ or ▽ ▽ ▽)	mm
Ø1	Diameter of the unmachined part of the spigot (only if ▽ or ▽ ▽ ▽)	mm
FS	Bevel width for chamfering (only for chamfering)	mm
ZFS	Tool tip plunge depth (only when chamfering)	mm

Cycle description

- 1 The control system positions the tool in rapid traverse (G0) at the retract plane height and at the safety distance. The start point is always on the positive X-axis.
- 2 The tool approaches the spigot contour in the semi-circle with machining feed. First the infeed to the machining depth takes place, then the movement in the plane. The circular spigot will be processed in the clockwise or counter-clockwise direction according to the programmed direction of rotation for machining (up-cut milling/down-cut milling).
- 3a Machining ▽ Roughing
When roughing the rectangular spigot will be bypassed, until the programmed finishing pass is reached.
- 3b Machining ▽ ▽ ▽ Finishing
During finishing the rectangular spigot will be bypassed, until depth Z1 is reached.
- 3c Machining - chamfering
During chamfering the edge on the top of the rectangular spigot will be breached.
- 4 Once the circular spigot has been bypassed once, the tool leaves the contour in the semi-circle and the infeed to the next machining plane takes place.
- 5 The circular spigot will again be approached in the semi-circle and bypassed once. This will be repeated until the programmed spigot depth is reached.
- 6 The tool moves back to the safety distance in rapid traverse (G0).

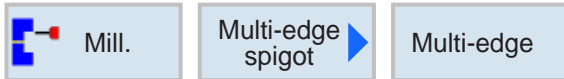

Multiple edge

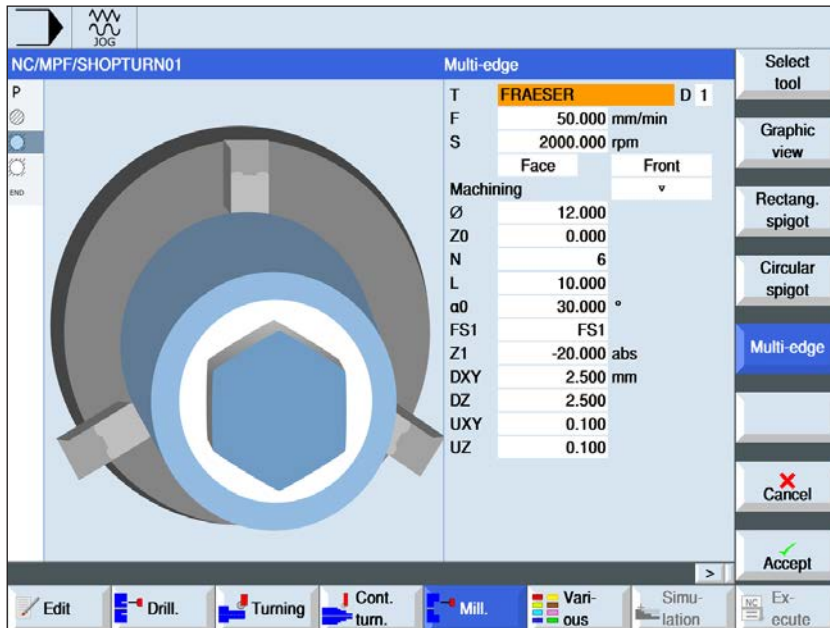

The "Select" button gives you the option to change parameters and/or units. To do this move the cursor to the appropriate field and press button.

Parameter	Description	Unit
T	Tool name	
D	Cutting number	
F	Feed	mm/min mm/tooth
S / V	Spindle speed or constant cutting speed	rpm m/min
Position	<ul style="list-style-type: none"> • in front • behind 	
Machining	<ul style="list-style-type: none"> • ▾ Roughing • ▾ ▾ Finishing • ▾ ▾ ▾ Edge finishing • Chamfering 	
Z0	Reference point Z	mm
Ø	Diameter of the unmachined part of the spigot	mm
N	Number of edges	
Key width or edge length	Key width or edge length (only if N is an integer)	
α0	Angle	degrees
R1 or FS1	Rounding radius or bevel width	

Parameter	Description	Unit
Z1	Multiple edge depth (absolute) or depth relative to Z0 (incremental) (only if ▽, ▽ ▽ ▽ or ▽ ▽ ▽ edge)	mm
DXY	<ul style="list-style-type: none"> • maximum plane infeed • maximum level infeed as a percentage of the mill diameter (only if ▽ and ▽ ▽ ▽) 	mm %
DZ	maximum depth infeed (only if ▽ or ▽ ▽ ▽)	mm
UXY	Finishing pass plane (only if ▽, ▽ ▽ ▽ or ▽ ▽ ▽ edge)	mm
UZ	Finishing pass depth (only if ▽ or ▽ ▽ ▽)	mm
FS	Bevel width for chamfering (only for chamfering)	mm
ZFS	Tool tip plunge depth (absolute or incremental) - (only for chamfering)	mm %

Cycle description

- 1 The control system positions the tool in rapid traverse (G0) at the retract plane height and at the safety distance.
- 2 The tool approaches to the multiple edge in the quarter circle at machining speed. First the infeed to the machining depth takes place, then the movement in the plane. The multiple edge will be processed in the clockwise or counter-clockwise direction according to the programmed direction of rotation for machining (up-cut milling/down-cut milling).
- 4 Once the first plane has been machined, the tool leaves the contour in the quarter circle and the infeed to the next machining plane takes place.
A multi edge with more than two edges is bypassed with a spiral shape. Multi edges with one or two edges, each edge is processed individually.
- 5 The multiple edge is again approached in the quarter circle. This will be repeated until the programmed multiple edge depth is reached.
- 6 The tool moves back to the safety distance in rapid traverse (G0).



Note:

The cycle is executed with the previously active path control mode G64 or precision stop G60.
If necessary, the appropriate command must be set before the cycle.

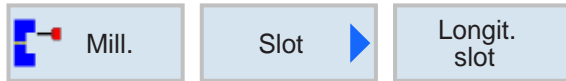

Longitudinal slot

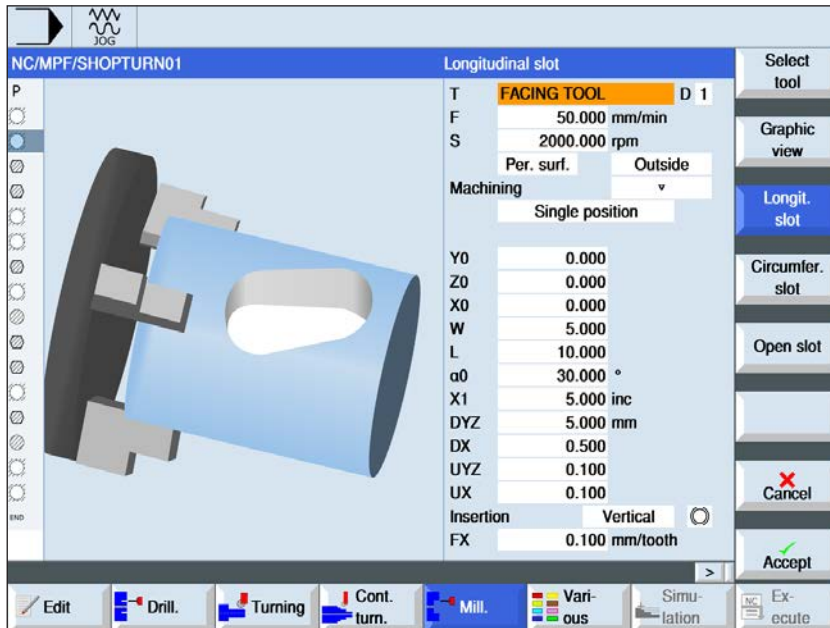

The "Select" button gives you the option to change parameters and/or units. To do this move the cursor to the appropriate field and press button.

Parameter	Description	Unit
T	Tool name	
D	Cutting number	
F	Feed	mm/min mm/tooth
S / V	Spindle speed or constant cutting speed	rpm m/min
Machining surface	<ul style="list-style-type: none"> • Front • Side 	
Position	<ul style="list-style-type: none"> • in front (front machining surface) • rear (front machining surface) • internal (side machining surface) • external (side machining surface) 	
Machining	<ul style="list-style-type: none"> • ▾ Roughing • ▾ ▾ Finishing • ▾ ▾ Edge finishing • Chamfering 	
Machining position	<ul style="list-style-type: none"> • Individual position Mill groove at the programmed position (X0, Y0, Z0). • Position template Mill several grooves at the programmed position template (e.g. partial circle, grid, line). 	
X0 Y0 Z0	Front: The positions are relative to the reference point: (only for "single position") Reference point in X, Y and Z	mm

Parameter	Description	Unit
Y0 Z0 X0	Side: The positions are relative to the reference point: Reference point Y or reference point polar angle – (only for individual position) Reference point Z – (only for individual position) Cylinder diameter \varnothing – (only for individual position)	mm
W	Width of the slot	mm
L	Length of the slot	mm
$\alpha 0$	Angle of the slot Front: $\alpha 0$ is relative to the X-axis Side: $\alpha 0$ is relative to the Y-axis	degrees
Z1 or X1	Groove depth (absolute) or depth relative to Z0 (incremental) (only if ∇ , $\nabla \nabla \nabla$, or $\nabla \nabla \nabla$ edge) Z1 for front machining surface or X1 for side	mm
DX or DYZ	<ul style="list-style-type: none"> • maximum plane infeed • maximum level infeed as a percentage of the mill diameter (only if ∇ or $\nabla \nabla \nabla$) DX for front machining surface or DYZ for side	mm %
DZ or DX	maximum depth infeed (only if ∇ , $\nabla \nabla \nabla$, or $\nabla \nabla \nabla$ edge) DZ for front machining surface or DX for side	mm
UX or UYZ	Finishing pass plane (only if ∇ , $\nabla \nabla \nabla$, or $\nabla \nabla \nabla$ edge) UX for front machining surface or UYZ for side	mm
UZ or UX	Finishing pass depth (only if ∇ or $\nabla \nabla \nabla$) UZ for front machining surface or UX for side	mm
Plunging	(only if ∇ or $\nabla \nabla \nabla$) <ul style="list-style-type: none"> • vertical: Plunge vertically on longitudinal slot center: It will be moved to the center of the pocket at the infeed depth. With this setting the milling cutting tool must cut via the center. • swinging: Plunge swinging on the center axis of the longitudinal groove: The center of the milling cutter swings on a straight line back and forth till it reaches the depth infeed. Once the depth has been reached, the path will be executed again without the depth infeed, in order to overcome the angular path of the plunge. 	
FZ or FX	Infeed depth (only with vertical plunging) FZ for front machining surface or FX for side	mm/min mm/tooth
FS	Bevel width for chamfering - (only for chamfering)	mm
ZFS or XFS	Tool tip plunge depth (absolute or incremental) (only for chamfering) ZFS for front machining surface or XFS for side	mm

Cycle description

1 The control system positions the tool in rapid traverse (G0) at the retract plane height and at the safety distance. The start point lies on the positive X-axis rotated by $\alpha 0$.

2 The tool mills into the material according to the selected strategy.

3 The longitudinal groove is always machined with the selected machining type from inside to outside.

3a Machining ▾ Roughing

During roughing the machining will be from the centre out of the individual planes of the groove until the depth Z1 is reached.

3b Machining ▾ ▾ Finishing

During finishing the edge will always be processed first. In the process the slot edge will be approached in the quarter circle in which it joins the corner radius. In the last infeed the bottom will be finished from the center.

3c Machining ▾ ▾ ▾ Edge finishing

Edge finishing takes place as with finishing. Only the last infeed (bottom finishing) is absent.

3d Machining - chamfering

During chamfering the edge on the top of the longitudinal slot will be breached.

4 The tool moves back to the safety distance in rapid traverse (G0).

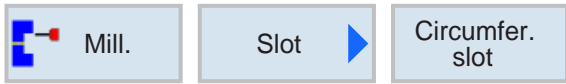

Circumferential slot



The "Select" button gives you the option to change parameters and/or units. To do this move the cursor to the appropriate field and press button.

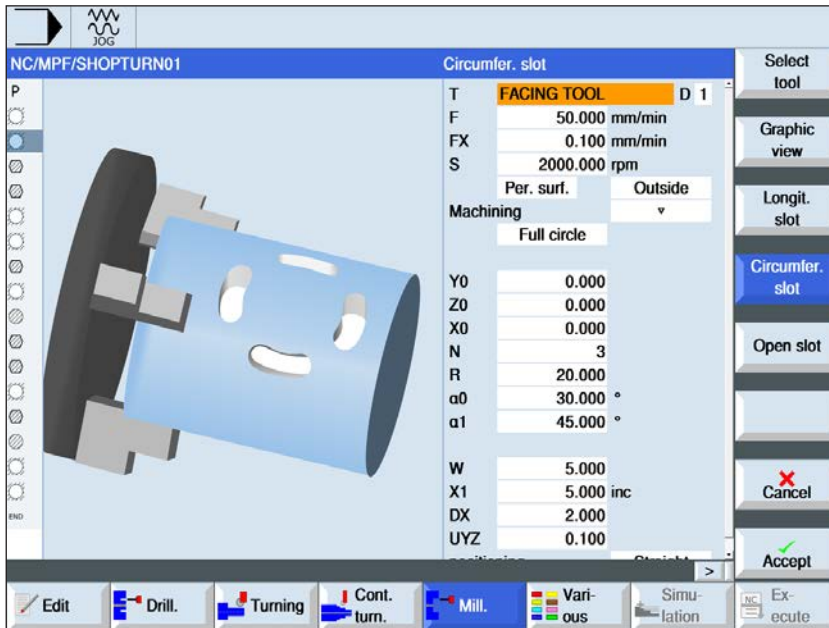

Parameter	Description	Unit
T	Tool name	
D	Cutting number	
F	Feed	mm/min mm/tooth
FZ	Infeed depth	mm/min
S / V	Spindle speed or constant cutting speed	rpm m/min
Machining surface	<ul style="list-style-type: none"> • Front • Side 	
Position	<ul style="list-style-type: none"> • in front (front machining surface) • rear (front machining surface) • internal (side machining surface) • external (side machining surface) 	
Machining	<ul style="list-style-type: none"> • ▾ Roughing • ▾ ▾ Finishing • ▾ ▾ Edge finishing • Chamfering 	
Circle template	<ul style="list-style-type: none"> • Full circle The circumferential slots will be positioned on a full circle. The distance from one circumferential slot to the next circumferential slot is always the same and will be calculated by the control system. • artial circle The circumferential slots will be positioned on a partial circle. The distance from one circumferential slot to the next circumferential slot can be defined by the angle $\alpha 2$. 	

Parameter	Description	Unit
X0 or L0 Y0 or C0 Z0	Front: The positions are relative to the reference point: Reference points X, Y, Z – (only for individual position)	mm mm or degrees mm
Y0 or C0 Z0 X0	Side: The positions are relative to the reference point: Reference point Y or reference point polar angle – (only for individual position) Reference point Z – (only for individual position) Cylinder diameter \varnothing – (only for individual position)	mm or degrees mm mm
N	Number of slots	mm
R	Radius of the circumferential slot	mm
α_0	Start angle	degrees
α_1	Opening angle of the groove	degrees
α_2	Angle of advance (only with partial circle)	degrees
W	Width of the slot	mm
Z1 or X1	Groove depth (absolute) or depth relative to Z0 (incremental) (only if ▽, ▽ ▽ ▽, or ▽ ▽ ▽ edge) Z1 for front machining surface and X1 for side	mm
DZ or DX	maximum depth infeed (only if ▽, ▽ ▽ ▽, or ▽ ▽ ▽ edge) DZ for front machining surface and DX for side	mm
FS	Bevel width for chamfering (only for chamfering)	mm
ZFS or XFS	Tool tip plunge depth (only when chamfering) ZFS for front machining surface and XFS for side	mm
UXY or UYZ	Finishing pass plane (only if ▽, ▽ ▽ ▽, or ▽ ▽ ▽ edge) UXY for front machining surface and UYZ for side	mm
Positioning	Positioning movement between the slots: <ul style="list-style-type: none"> • Straight line: Next position will be approached in rapid traverse in a straight line. • Circle: Next position will be approached on a circular path with the programmed feed FP. 	

Instructions:

Enter to create a circumferential slot for number (N)=1 and opening angle (α_1) = 360°.



Cycle description

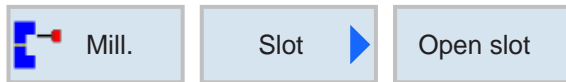

- 1** The control system positions the tool in rapid traverse (G0) at the retract plane height on the center point of the half circle at the slot end and at the safety distance. The start point lies on the positive X-axis rotated by $\alpha 0$.
- 2** The tool mills into the material with the machining feed according to the selected strategy. The max. infeed in the Z-direction as well as the finishing pass will be taken into account.
- 3a Machining ▽ ▽ ▽ Roughing**
During roughing the individual planes of the slot will be processed from the centre point of the half circle at the slot end until the depth Z1 is reached.
Minimum diameter of the milling tool: $1/2 \text{ Slot width } W - \text{Finishing pass } UXY \leq \text{Milling cutting tool diameter}$
- 3b Machining ▽ ▽ ▽ Finishing**
During finishing the edge will always be processed first, until depth Z1 is reached. In the process the slot edge will be approached in the quadrant in which it joins the radius. With the last feed there will be finished from the center point of the semi-circle at the slot end from the center.
Minimum diameter of the milling tool: $1/2 \text{ Slot width } W \leq \text{milling cutter tool}$
- 3c Machining ▽ ▽ ▽ Edge finishing**
Edge finishing takes place as with finishing. Only the last infeed (bottom finishing) is absent.
Minimum diameter of the milling tool: Finishing pass $UXY \leq \text{milling cutter tool diameter}$
- 3d Machining - chamfering**
During chamfering the edge on the top of the circular slot will be breached.
- 4** Once the first circumferential slot is finished, the tool moves in rapid traverse to the retract plane.
- 5** The following circumferential slot will be approached on a straight line or circular path and then milled.
- 6** The tool moves back to the safety distance in rapid traverse (G0).

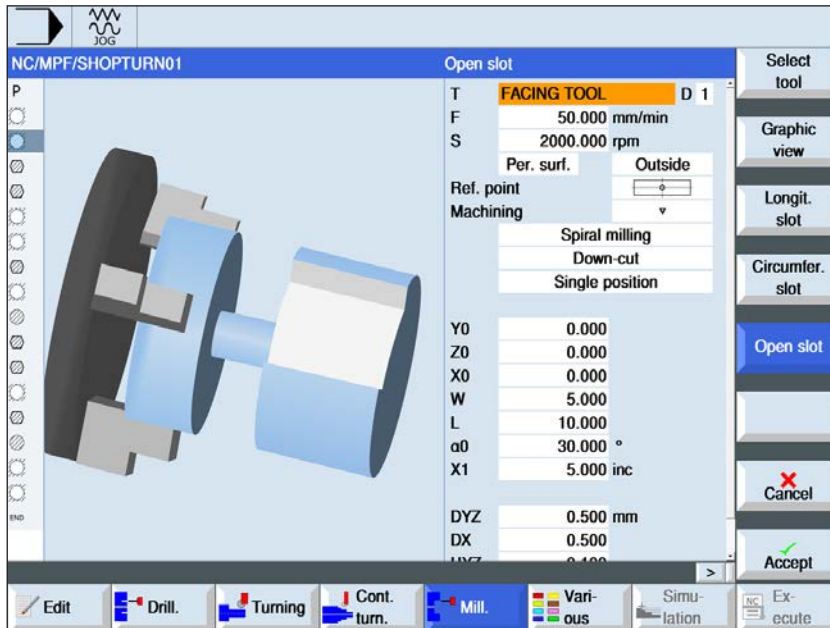

Open slot

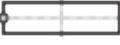

The "Select" button gives you the option to change parameters and/or units. To do this move the cursor to the appropriate field and press button.

Parameter	Description	Unit
T	Tool name	
D	Cutting number	
F	Feed	mm/min mm/tooth
S / V	Spindle speed or constant cutting speed	rpm m/min
Machining surface	<ul style="list-style-type: none"> • Front • Side 	
Position	<ul style="list-style-type: none"> • in front (front machining surface) • rear (front machining surface) • internal (side machining surface) • external (side machining surface) 	
Reference point	<ul style="list-style-type: none"> •  (left edge) •  (center) •  (right edge) 	
Machining	<ul style="list-style-type: none"> • ▾ Roughing • ▾ ▾ Pre-finishing • ▾ ▾ ▾ Finishing • ▾ ▾ ▾ Floor finishing • ▾ ▾ ▾ Edge finishing • Chamfering 	
Technology	<ul style="list-style-type: none"> • Trochoidal milling Circular movement of the mill through the slot and back again. • Plunge milling Sequential drilling movements along the tool axis. 	

Parameter	Description	Unit
Milling direction	<ul style="list-style-type: none"> • Up-cut • Downcut • Up cut - Down cut 	
Machining position	<ul style="list-style-type: none"> • Individual position Mill slot at the programmed position (X0, Y0, Z0). • Position template Mill several slots on a programmed position template (e.g.: full circle or grid). 	
X0 or L0 Y0 or C0 Z0	Front: The positions are relative to the reference point: Reference points X, Y, Z – (only for individual position)	mm mm or degrees mm
Y0 or C0 Z0 X0	Side: The positions are relative to the reference point: Reference point Y or reference point polar angle – (only for individual position) Reference point Z – (only for individual position) Cylinder diameter \varnothing – (only for individual position)	mm or degrees mm mm
W	Width of the slot	mm
L	Length of the slot	mm
α_0	Angle of the slot	Degrees
Z1 or X1	Slot depth (absolute) or depth relative to Z0 (incremental) (only if ∇ , $\nabla\nabla$ or $\nabla\nabla\nabla$) Z1 for front machining surface and X1 for side	mm
DXY or DYZ	<ul style="list-style-type: none"> • maximum plane infeed • Position template maximum level infeed as a percentage of the mill diameter (only when ∇) DXY for front machining surface and DYZ for side	mm
DZ or DX	maximum depth infeed (only if ∇ , $\nabla\nabla$, $\nabla\nabla\nabla$ or $\nabla\nabla\nabla$ edge) - (only for trochoidal milling) DZ for front machining surface and DX for side	mm
UXY or UYZ	Finishing pass plane (slot edge) (only when ∇ , $\nabla\nabla$, or $\nabla\nabla\nabla$ floor) UXY for front machining surface and UYZ for side	mm
UZ or UX	Finishing pass depth (slot bottom) (only if ∇ , $\nabla\nabla\nabla$ or $\nabla\nabla\nabla$ edge) UZ for front machining surface and UX for side	mm
FS	Bevel width for chamfering (only for chamfering)	mm
ZFS or XFS	Tool tip plunge depth (absolute or incremental) (only for chamfering) ZFS for front machining surface and XFS for side	mm

General limit conditions:

- Finishing 1/2 slot width $W \leq$ mill diameter
- Finishing edge finishing pass $UXY \leq$ mill diameter
- Chamfer tip angle must be registered in tool table.

Limit conditions for trochoidal milling:

- Roughing: 1/2 Slot width W – Finishing pass $UXY \leq$ Milling cutting tool diameter
- Slot width: at least 1.15x mill diameter + finishing pass at most 2x mill diameter + 2x finishing pass
- Radial infeed: at least 0.02x mill diameter, at most 0.25x mill diameter
- Maximum infeed depth \leq Cutting height of the mill

Limit conditions for plunge milling:

- Roughing: 1/2 Slot width W – Finishing pass

$UXY \leq$ Milling cutting tool diameter

- Maximum radial infeed: The maximum infeed is dependent on the cutting width of the mill.
- Increment: The sideways increment results from the desired slot width, the milling cutting tool diameter and the finishing pass.
- Retraction: The retraction takes place with withdrawal at an angle of 45° , if the wrap angle is less than 180° . Otherwise a vertical retraction takes place as with drilling.
- Withdrawal: The withdrawal takes place vertically in relation to the wrapped surface.
- Safety distance: Move the safety distance beyond the end of the workpiece to avoid rounding of the slot walls at the ends.

The cutting width of the mill for the maximum radial infeed cannot be tested.

Cycle description**Trochoidal milling**

1 The control system positions the tool in rapid traverse (G0) at the start point in front of the groove and at the safety distance. The start point lies on the positive X-axis rotated by $\alpha 0$.

2 The tool feeds in to the cut depth.

3 The open slot is always machined with the selected machining type over the complete slot length.

3a Machining ▾ Roughing

The roughing is carried out with a circular movement of the mill cutting tool. During these movements the mill will be continually fed further into the plane. If the mill tool has traced the entire slot, the mill also moves back in a circular movement and in this way drops to the next level (infeed depth) in the Z-direction. This procedure repeats until the preset slot depth plus finishing pass is reached.

3b Machining ▾ ▾ Pre-finishing

If there is too much residual material on the slot walls, superfluous corners will be cleared away to the finishing pass.

3c Machining ▾ ▾ ▾ Finishing

When finishing the walls the mill moves along the slot walls, in which, as with roughing in the Z-direction, also against its feed in step by step. In this the mill moves over the slot start and slot end by the safety distance, in order to guarantee that the slot wall has an even surface over the entire length of the slot.

3d Machining ▾ ▾ ▾ Floor finishing

In bottom finishing the mill moves into the finished slot once and once back.

3e Machining ▾ ▾ ▾ Edge finishing

Edge finishing takes place as with finishing. Only the last infeed (bottom finishing) is absent.

3f Machining - chamfering

During chamfering the edge on the top of the slot will be breached.

4 The tool moves back to the safety distance in rapid traverse (G0).

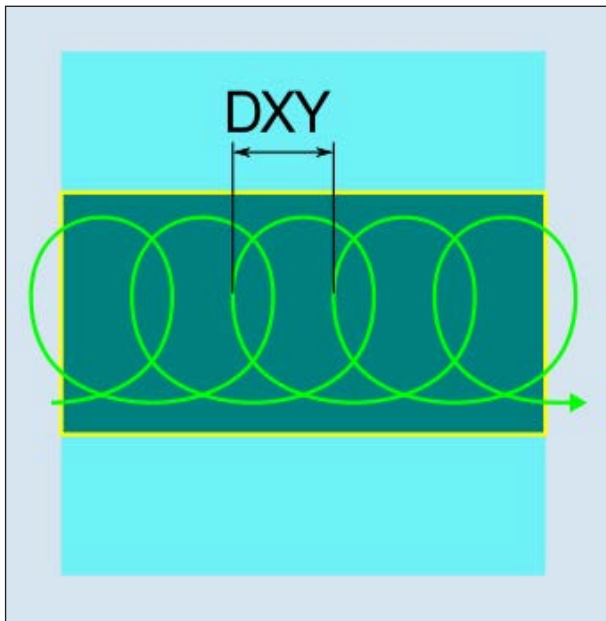

Down-cut or up-cut milling - plunge milling

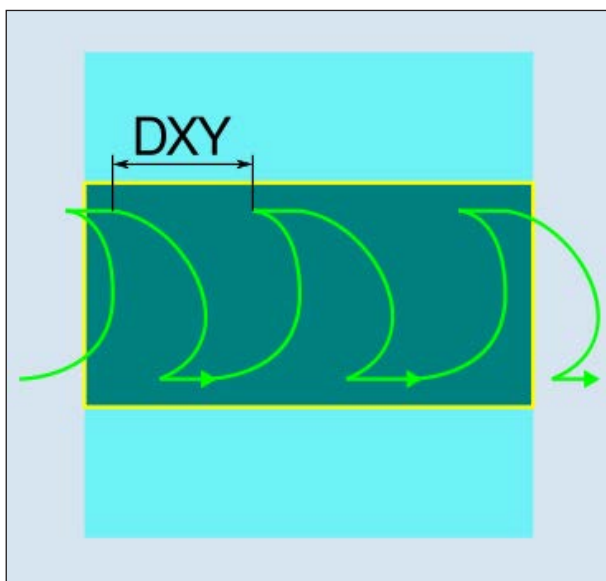

Down-cut milling/Up-cut milling - trochoidal milling

Cycle description

Plunge milling

- 1 The control system positions the tool in rapid traverse (G0) at the start point in front of the groove and at the safety distance. The start point lies on the positive X-axis rotated by $\alpha 0$.
- 2 The open slot is always machined with the selected machining type over the complete slot length.

3a Machining ▾ Roughing

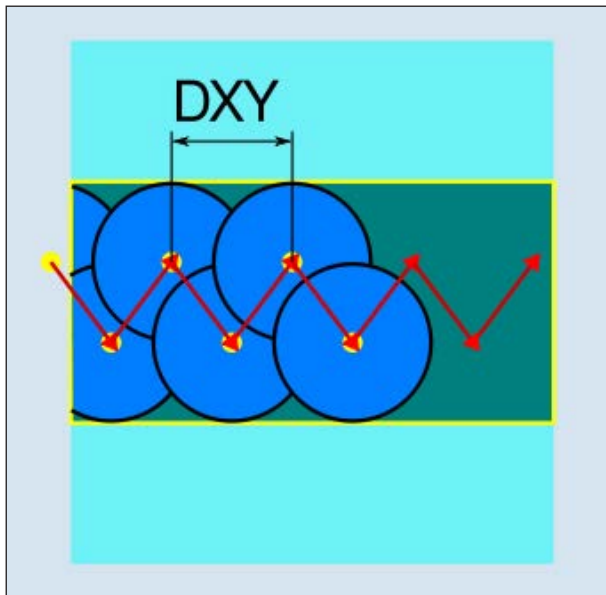

Down-cut or up-cut - plunge milling

The roughing of the slot takes place sequentially along the slot through vertical plunge movements of the mill with work feed. Afterwards there is a withdrawal and a position movement to the next plunge point. There will be alternate plunging on the left and right wall, along the slot, displaced by the infeed amount in each case. The first plunge movement takes place at the edge of the slot with a mill operation of a half infeed minus the safety distance. (Thus in the open air if the safety distance is larger than the infeed.) For this cycle the maximum width of the slot must be smaller than the double width of the mill + finishing pass. After each plunging movement the mill also lifts up by the safety distance at working feed. This happens according to possibility in the so-called retract procedure, i.e. when the mill has a contact angle of less than 180° it lifts under 45° in the opposite direction of the angle bisector of the contact angle from the bottom. Then the mill moves over the material.

3b Machining ▾ ▾ Pre-finishing

If there is too much residual material on the slot walls, superfluous corners will be cleared away to the finishing pass.

3c Machining ▾ ▾ ▾ Finishing

When finishing the walls the mill moves along the slot walls, in which, as with roughing in the Z-direction, also against its feed in step by step. In this the mill moves over the slot start and slot end by the safety distance, in order to guarantee that the slot wall has an even surface over the entire length of the slot.

3d Machining ▾ ▾ ▾ Floor finishing

In bottom finishing the mill moves into the finished slot once and once back.

3e Machining ▾ ▾ ▾ Edge finishing

Edge finishing takes place as with finishing. Only the last infeed (bottom finishing) is absent.

3f Machining - chamfering

During chamfering the edge on the top of the slot will be breached.

- 4 The tool moves back to the safety distance in rapid traverse (G0).



Thread milling

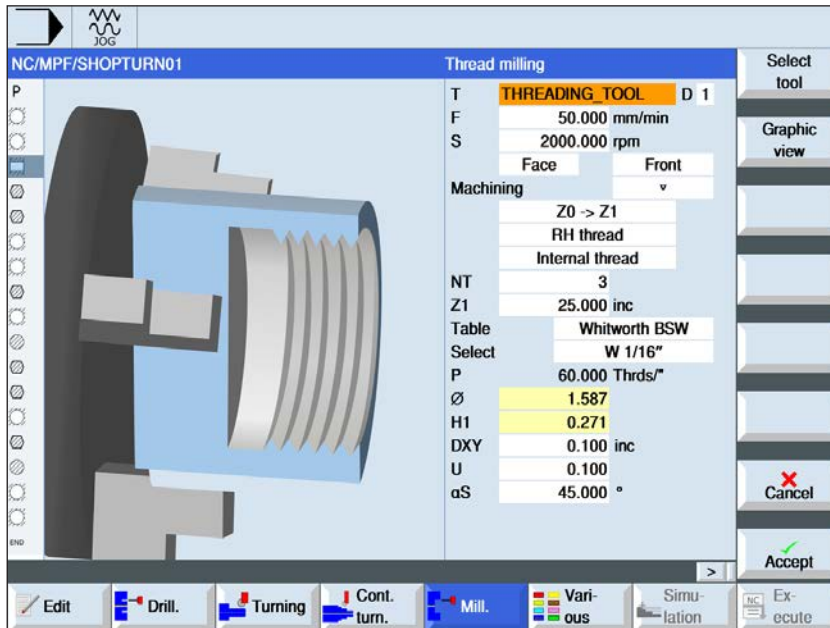

The "Select" button gives you the option to change parameters and/or units. To do this move the cursor to the appropriate field and press button.

Parameter	Description	Unit
T	Tool name	
D	Cutting number	
F	Feed	mm/min mm/tooth
S / V	Spindle speed or constant cutting speed	rpm m/min
Machining surface	<ul style="list-style-type: none"> • Front 	
Position	<ul style="list-style-type: none"> • in front • behind 	
Machining	<ul style="list-style-type: none"> • ▾ Roughing • ▾ ▾ Finishing 	
Machining direction	<ul style="list-style-type: none"> • Z0 → Z1 Top-down machining • Z1 → Z0 Bottom-up machining 	
Thread's direction of rotation	<ul style="list-style-type: none"> • Right-hand thread A right-hand thread will be milled. • Left-hand thread A left-hand thread will be milled. 	
Thread position	<ul style="list-style-type: none"> • Internal thread An internal thread will be milled. • External thread An external thread will be milled. 	

Parameter	Description	Unit
NT	Number of teeth per blade Single or multi-tooth milling inserts can be used. The required movements will be executed by the cycle internally in such a way that upon reaching the thread end position the tip of the lower tooth of a milling insert matches the programmed end position. Depending on the blade geometry a clearance path at the bottom of the workpiece has to be taken into account.	
Z1	End point of the thread (absolute) or thread length (incremental)	mm
Table	Thread selection table: <ul style="list-style-type: none"> • none • ISO metric • Whitworth BSW • Whitworth BSP • UNC 	
Selection	not if table "no": Selection of the table value e.g.: <ul style="list-style-type: none"> • M1; M5; etc. (ISO metric) • W1/8"; etc. (Whitworth BSW) • G 1 3/4"; etc. (Whitworth BSP) • N8 - 32 UNC; etc. (UNC) (also see thread table with respective pitches)	
P	Display of the thread lead (only with table selection "none") <ul style="list-style-type: none"> • in MODULE: $MODULE = \text{pitch}/\pi$ • in threads per inch: as is typical with pipe threads. With the per inch input, in the first parameter field the whole number before the decimal point is entered and in the second and third field the number after the decimal point is entered as a fraction. • in mm/rev • in inches/rev The thread lead is dependent on the tool used.	MODULE Threads/" mm/rev in/rev
∅	Nominal diameter, Example: Nominal diameter of M12 = 12 mm	mm
H1	Thread depth	mm
DX Y	maximum plane infeed	mm
αS	Start angle	Degrees
U	Finishing pass in X and Y	mm

Instructions:

Textboxes marked yellow contain default values from the thread table. They can also be changed downstream.



Thread table

ISO_METRIC		WHITWORTH_BSW		WHITWORTH_BSP		UNC	
M 1	0.250	W 1/16"	60.000	G 1/16"	28.000	N 1 - 64 UNC	64.000
M 1.2	0.250	W 3/32"	48.000	G 1/8"	28.000	N 2 - 56 UNC	56.000
M 1.6	0.350	W 1/8"	40.000	G 1/4"	19.000	N 3 - 48 UNC	48.000
M 2	0.400	W 5/32"	32.000	G 3/8"	19.000	N 4 - 40 UNC	40.000
M 2.5	0.450	W 3/16"	24.000	G 1/2"	14.000	N 5 - 40 UNC	40.000
M 3	0.500	W 7/32"	24.000	G 5/8"	14.000	N 6 - 32 UNC	32.000
M 3.5	0.600	W 1/4"	20.000	G 3/4"	14.000	N 8 - 32 UNC	32.000
M 4	0.700	W 5/16"	18.000	G 7/8"	14.000	N 10 - 24 UNC	24.000
M 4.5	0.750	W 3/8"	16.000	G 1"	11.000	N 12 - 24 UNC	24.000
M 5	0.800	W 7/16"	14.000	G 1 1/8"	11.000	1/4" - 20 UNC	20.000
M 6	1.000	W 1/2"	12.000	G 1 1/4"	11.000	5/16" - 18 UNC	18.000
M 8	1.250	W 9/16"	12.000	G 1 3/8"	11.000	3/8" - 16 UNC	16.000
M 10	1.500	W 5/8"	11.000	G 1 1/2"	11.000	7/16" - 14 UNC	14.000
M 12	1.750	W 3/4"	10.000	G 1 3/4"	11.000	1/2" - 13 UNC	13.000
M 14	2.000	W 7/8"	9.000	G 2"	11.000	9/16" - 12 UNC	12.000
M 16	2.000	W 1"	8.000	G 2 1/4"	11.000	5/8" - 11 UNC	11.000
M 18	2.500	W 1 1/8"	7.000	G 2 1/2"	11.000	3/4" - 10 UNC	10.000
M 20	2.500	W 1 1/4"	7.000	G 2 3/4"	11.000	7/8" - 9 UNC	9.000
M 22	2.500	W 1 3/8"	6.000	G 3"	11.000	1" - 8 UNC	8.000
M 24	3.000	W 1 1/2"	6.000	G 3 1/4"	11.000	1 1/8" - 7 UNC	7.000
M 27	3.000	W 1 5/8"	5.000	G 3 1/2"	11.000	1 1/4" - 7 UNC	7.000
M 30	3.500	W 1 3/4"	5.000	G 3 3/4"	11.000	1 3/8" - 6 UNC	6.000
M 33	3.500	W 1 7/8"	4.500	G 4"	11.000	1 1/2" - 6 UNC	6.000
M 36	4.000	W 2"	4.500	G 5"	11.000	1 3/4" - 5 UNC	5.000
M 39	4.000	W 2 1/4"	4.000	G 6"	11.000	2" - 4 1/2 UNC	4.500
M 42	4.500	W 2 1/2"	4.000			2 1/4" - 4 1/2 UNC	4.500
M 45	4.500	W 2 3/4"	3.500			2 1/2" - 4 UNC	4.000
M 48	5.000	W 3"	3.500			2 3/4" - 4 UNC	4.000
M 52	5.000	W 3 1/4"	3.250			3" - 4 UNC	4.000
M 56	5.500	W 3 1/2"	3.250			3 1/4" - 4 UNC	4.000
M 60	5.500	W 3 3/4"	3.000			3 1/2" - 4 UNC	4.000
M 64	6.000	W 4"	3.000			3 3/4" - 4 UNC	4.000
M 68	6.000					4" - 4 UNC	4.000

Thread table with pitches

Cycle description**Internal thread**

- 1 The control system positions the tool in the spindle axis in rapid traverse (G0) to the safety distance above the reference point.
- 2 Approach start point of the inward circular arc in the current plane with rapid traverse.
- 3 Infeed with rapid traverse to a start point in the tool axis calculated internally by the control system.
- 4 Inward arc movement at thread diameter at programmed feed to an inward arc calculated internally by the control system, taking into account the finishing pass and maximum infeed depth.
- 5 Thread milling on a spiral path in the clockwise direction or in the counter-clockwise direction (dependent on left-hand/right-hand thread, with number of blade teeth in a milling insert (NT) ≥ 2 only 1 revolution, displaced in the Z-direction).
- 6 Outward movement on a circular path with the same direction of rotation and the programmed feed.
- 7 With a programmed number of thread pitches per blade NT > 2 the tool will be infed by the number NT-1 in the Z-direction (offset). Repeat points 4 to 7 until the programmed thread depth is reached.
- 8 If the plane infeed is smaller than the thread depth, points 3 to 7 will be repeated until the thread depth + programmed extent is reached.
- 9 The tool moves back in rapid traverse (G0) to the coordinates of the thread center on the retraction plane.

Limit conditions for internal thread milling:

During internal thread milling the milling cutting tool diameter may not exceed the following value:
 mill diameter $<$ (Nominal diameter - 2x thread depth H1)

Cycle description**External thread**

- 1 The control system positions the tool in the spindle axis in rapid traverse (G0) to the safety distance above the reference point.
- 2 Approach start point of the inward circular arc in the current plane with rapid traverse.
- 3 Infeed with rapid traverse to a start point in the tool axis calculated internally by the control system.
- 4 Inward arc movement at thread diameter at programmed feed to an inward arc calculated internally by the control system, taking into account the finishing pass and maximum infeed depth.
- 5 Thread milling on a spiral path in the clockwise direction or in the counter-clockwise direction (dependent on left-hand/right-hand thread, with (NT) ≥ 2 only 1 revolution, displaced in the Z-direction).
- 6 Outward movement on a circular path in the direction opposite to that set for rotation and the programmed feed.
- 7 With a programmed number of thread pitches per blade NT > 2 the tool will be infed by the number NT-1 in the Z-direction (offset). Repeat points 4 to 7 until the programmed thread depth is reached.
- 8 If the plane infeed is smaller than the thread depth, points 3 to 7 will be repeated until the thread depth + programmed extent is reached.
- 9 The tool moves back in rapid traverse (G0) to the coordinates of the thread center on the retraction plane.





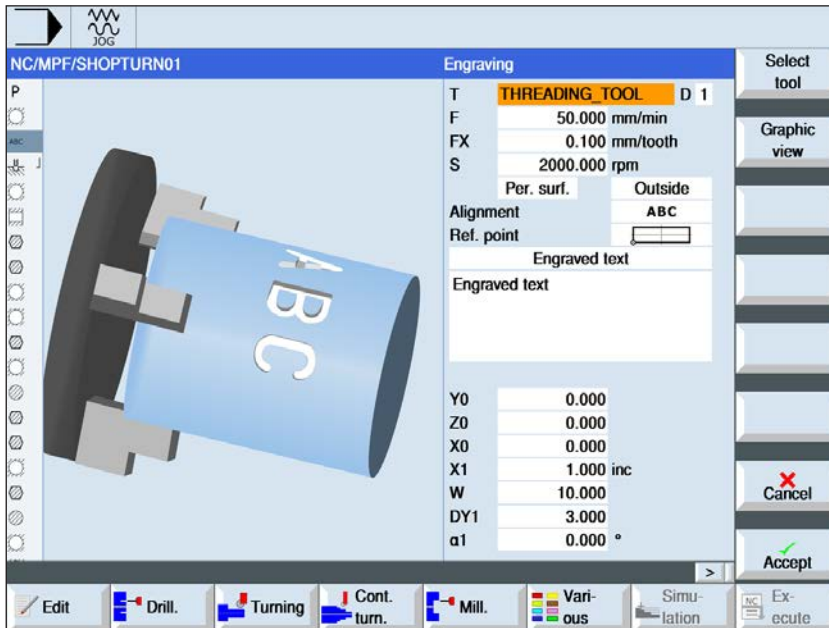



Engraving

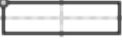
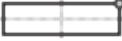

The "Select" button gives you the option to change parameters and/or units. To do this move the cursor to the appropriate field and press button.

Parameter	Description	Unit
T	Tool name	
D	Cutting number	
F	Feed	mm/min mm/tooth
S / V	Spindle speed or constant cutting speed	rpm m/min
FX FZ	Infeed depth	m/min mm/tooth
Machining surface	<ul style="list-style-type: none"> • Front • Side 	
Position	<ul style="list-style-type: none"> • in front (front machining surface) • rear (front machining surface) • internal (side machining surface) • external (side machining surface) 	
Alignment	<ul style="list-style-type: none"> • ABC (linear alignment) • A B C (curved alignment) • A B C (curved alignment) 	

Parameter	Description	Unit
Reference point	<ul style="list-style-type: none"> •  (bottom left) •  (bottom center) •  (bottom right) •  (top left) •  (top right) •  (top center) •  (left edge) •  (center) •  (right edge) 	
Engraving text Variable name	<ul style="list-style-type: none"> • Engraved text (max. 100 characters) • Variable name: <code>_TXT[1]</code>: string variable, in which the text is stored: has to be defined earlier in the program. 	
X0 or L0 Y0 or C0 Z0	Front: The positions are relative to the reference point: Positioning angle for machining area Reference point X or reference point polar length Reference point Y or reference point polar angle Reference point Z	Degrees mm mm or degrees mm
Y0 or C0 Z0 X0	Side: The positions are relative to the reference point: Reference point Y or reference point polar angle Reference point Z Cylinder diameter \varnothing	mm or degrees mm mm
Z1 or X1	Engraving depth (absolute) or depth related to Z0 or X0 (incremental) Z1 for front machining surface and X1 for side	degrees
W	Symbol height	mm
DX1 or $\alpha 2$ DY1 or $\alpha 2$	Character spacing or opening angle (only for curved alignment) DX1 for front machining surface and DY1 for side	mm degrees
DX1 or DX2 DY1 or DY2	Character spacing or total width (only for linear alignment) DX1/2 for front machining surface and DY1/2 for side	mm
$\alpha 1$	Text direction(only if linear alignment)	degrees
YM CM	Center point Y or C (absolute) – (only for curved alignment) - (only for side machining surface)	mm or degrees
ZM	Center point Z (absolute) – (only for curved alignment) - (only for side machining surface)	mm

Cycle description

- 1** The control system positions the tool in the spindle axis in rapid traverse (G0) to the safety distance above the start point.
- 2** The tool moves with infeed FZ to the machining depth Z1 and mills the symbol.
- 3** The tool withdraws to the safety distance in rapid traverse and moves in a straight line to the next symbol.
- 4** Steps 2 and 3 will be repeated until the whole text has been milled.
- 5** The tool moves back in rapid traverse (G0) to the coordinates of the thread center on the retraction plane.

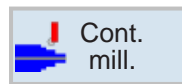

Contour milling

- New contour
- Path milling
- Pre-drilling
- Pocket
- Spigot

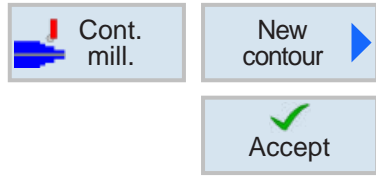

Create new contour

- Enter contour name and confirm with softkey. If the program name exists already, an error machine pops up with a prompt to enter a new name.

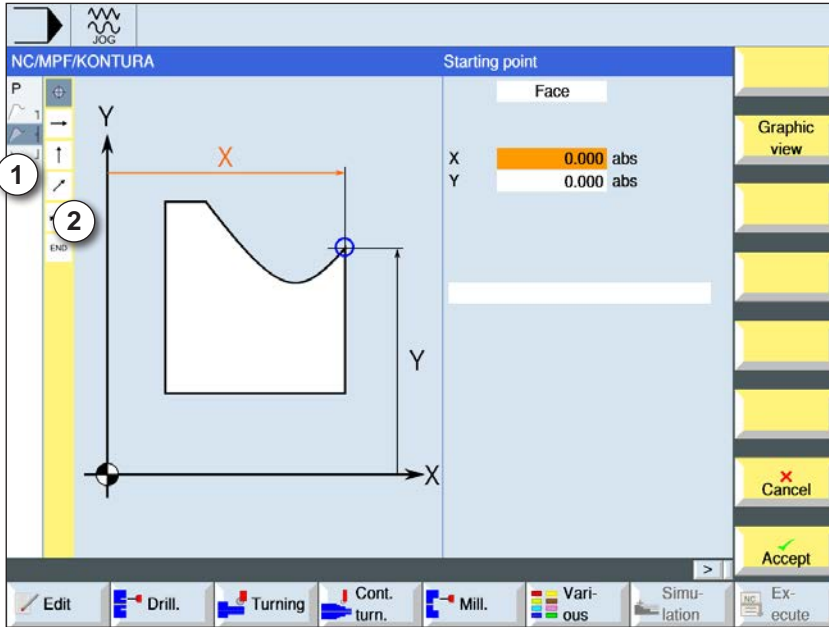

- 1 Cycle symbols
- 2 Contour element

Instructions:
 The individual contour elements of a contour will be shown symbolically in the indicated sequence on the left alongside the graphic window (2).
 On the far left the individual cycles of a program are symbolically represented in the indicated sequence (1).

First decide the machining surface - side or front.

- Then the start point of the contour will be entered.
- If applicable, enter additional commands in the form of G-Code.
- Press softkey to apply the cycle in the workpiece program.
- Enter individual contour elements and apply with softkey:

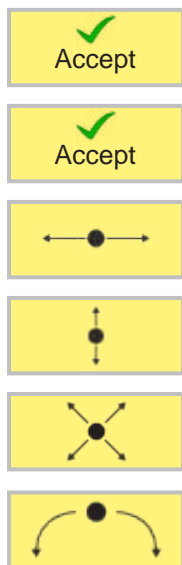

Straight line element in Z

Straight line element in Y

Straight line element in XY

Circular element



Contour element straight line X

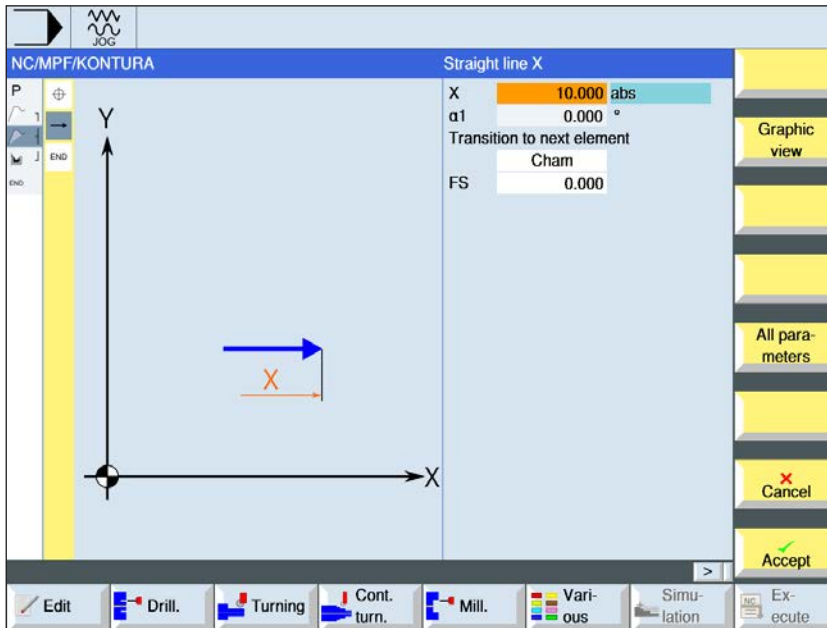

The "Select" button gives you the option to change parameters and/or units. To do this move the cursor to the appropriate field and press button.

Parameter	Description	Unit
X	End point X (absolute or incremental)	mm
$\alpha 1$	Start angle e.g. to X-axis	degrees
$\alpha 2$	Angle to previous element	degrees
Transition to succeeding element	Type of transition <ul style="list-style-type: none"> • Radius • Bevel 	
R	Transition to succeeding element - Radius	mm
FS	Transition to succeeding element - Bevel	mm
Additional commands	Additional G-code commands	



Contour element straight line Y

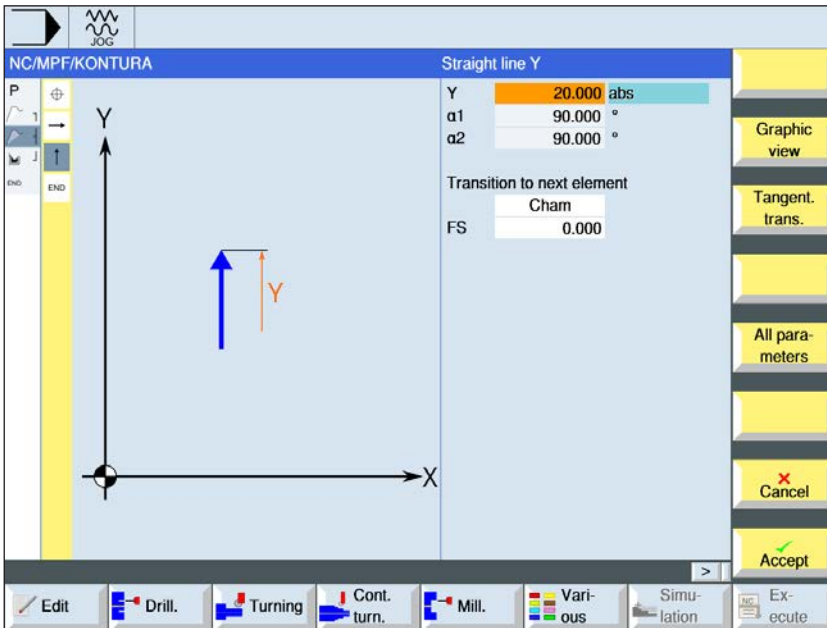

The "Select" button gives you the option to change parameters and/or units. To do this move the cursor to the appropriate field and press button.

Parameter	Description	Unit
Y	End point Y (absolute or incremental)	mm
$\alpha 1$	Start angle e.g. to X-axis	degrees
$\alpha 2$	Angle to previous element	degrees
Transition to succeeding element	Type of transition • Radius • Bevel	
R	Transition to succeeding element - Radius	mm
FS	Transition to succeeding element - Bevel	mm
Additional commands	Additional G-code commands	



Contour element straight line XY

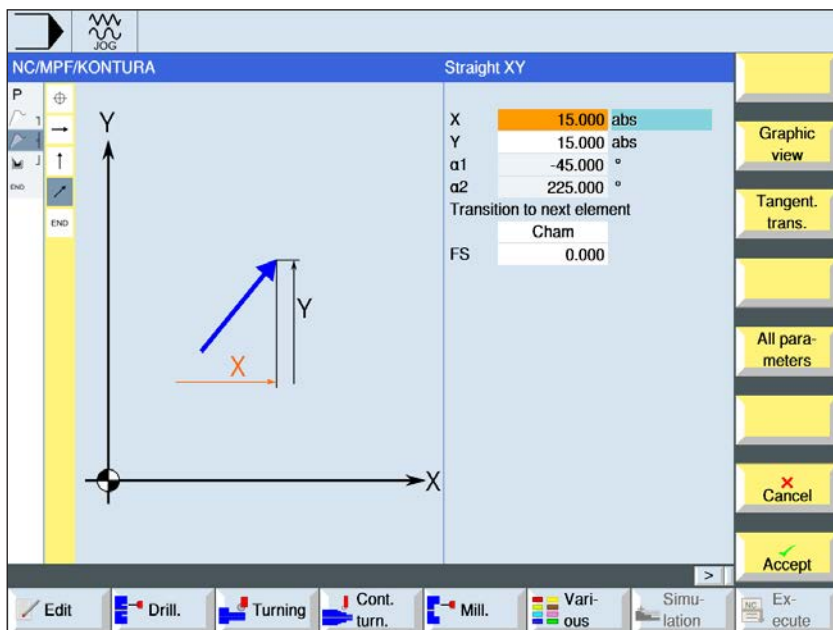

The "Select" button gives you the option to change parameters and/or units. To do this move the cursor to the appropriate field and press button.

Parameter	Description	Unit
X	End point X (absolute or incremental)	mm
Y	End point Y (absolute or incremental)	mm
L	Length	mm
$\alpha 1$	Start angle e.g. to X-axis	degrees
$\alpha 2$	Angle to previous element	degrees
Transition to succeeding element	Type of transition • Radius • Bevel	
R	Transition to succeeding element - Radius	mm
FS	Transition to succeeding element - Bevel	mm
Additional commands	Additional G-code commands	



Contour element circle

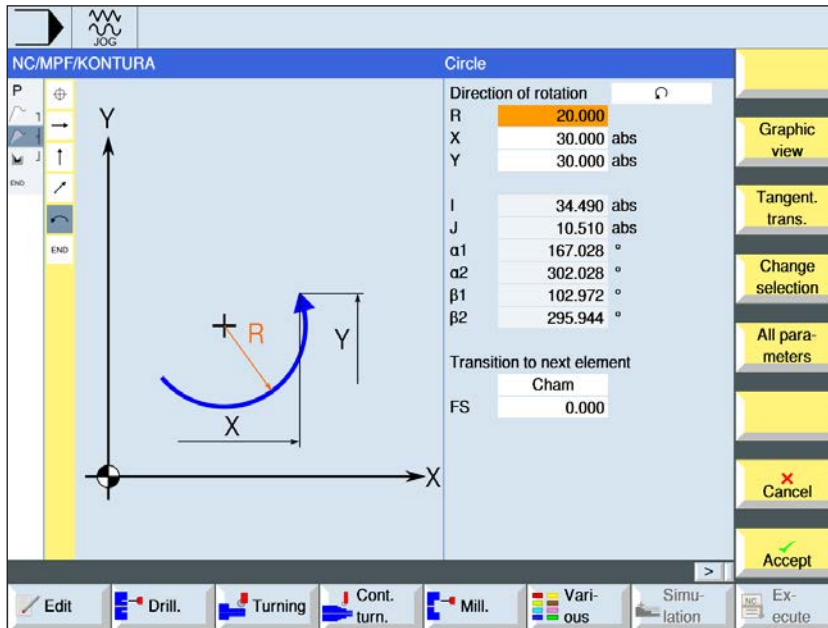

The "Select" button gives you the option to change parameters and/or units. To do this move the cursor to the appropriate field and press button.

Parameter	Description	Unit
Direction of rotation	<ul style="list-style-type: none"> Direction of rotation right Direction of rotation left 	
R	Radius	mm
X Y	Coordinates of the end points in X and Y (absolute or incremental)	mm
I J	Coordinates of the circle centre in I and J (absolute or incremental)	mm
α1	Start angle to X-axis	degrees
α2	Angle to previous element	degrees
β1	End angle to Z-axis	degrees
β2	Opening angle	degrees
Transition to succeeding element	Type of transition <ul style="list-style-type: none"> • Radius • Bevel 	
R	Transition to succeeding element - Radius	mm
FS	Transition to succeeding element - Bevel	mm
Additional commands	Additional G-code commands	

	Other functions:
Graphic view	<ul style="list-style-type: none">• Change view This softkey switches between the graphics window and the input screen.
Tangent. trans.	<ul style="list-style-type: none">• Tangent to previous element Program the transition to the previous element as a tangent.
Dialog select	<ul style="list-style-type: none">• Dialog selection If two different contour options result from previously entered parameters, one of them must be selected.
Dialog accept	<p>Apply the selection contour option with the softkey.</p>
Change selection	<ul style="list-style-type: none">• change dialog concerned When a dialogue selection has already been made this softkey changes the selected solution again.
All parameters	<ul style="list-style-type: none">• Show additional parameters If additional parameters should be shown for individual contour elements, e.g. to enter additional commands.
Close contour	<ul style="list-style-type: none">• Close contour The contour will be closed from the current position with a straight line to the start point.

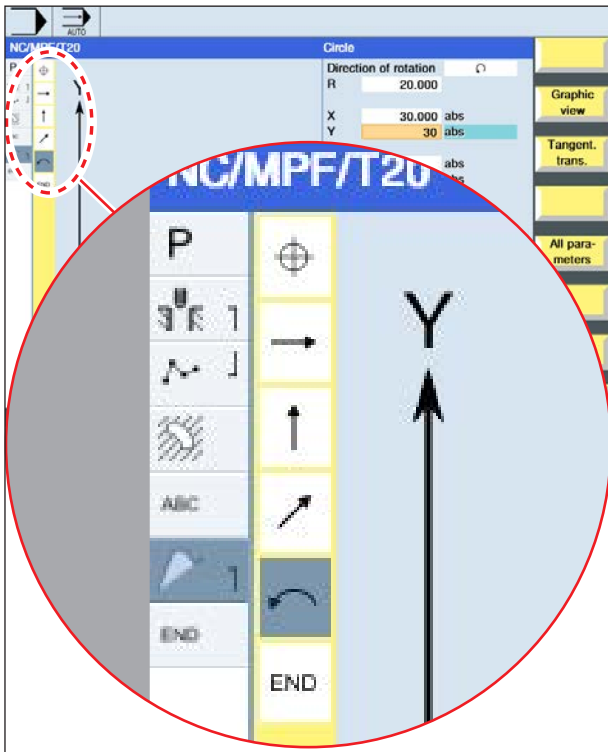

Symbol representation of the contour elements:

Contour element	Symbol	Meaning
Start point	⊕	Start point of the contour
Straight up Straight down	↑ ↓	Straight line in 90° grid
Straight left Straight right	← →	Straight line in 90° grid
Straight line anywhere	↗	Straight line with arbitrary pitch
Curve right Curve left	↪ ↩	Circle
Contour termination	END	End of the contour description

The contour element can accept different line types and colours:

- Black: Programmed contour
- Orange: Current contour element
- Line-dot-dot: Partially-defined element

The scaling of the coordinate system adapts to the change of the entire contour.

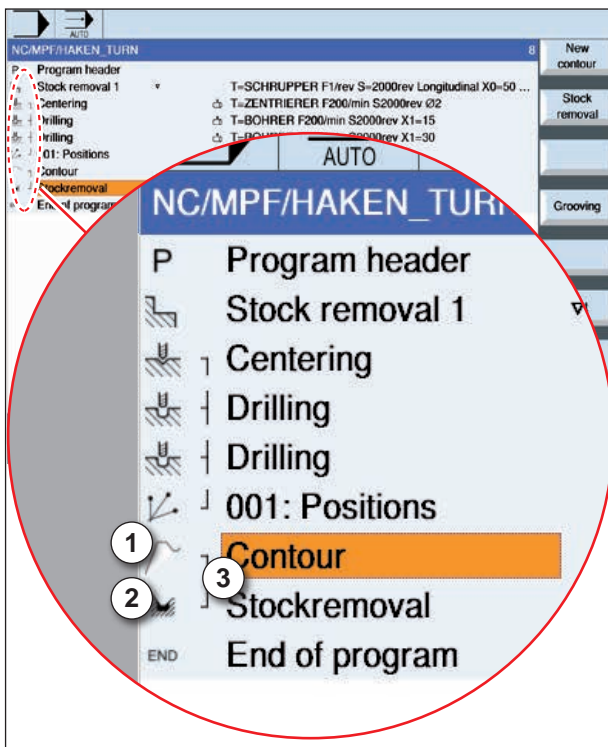

Link representation of contour elements with contour cycles:

A complete contour cycle consists of the associated contour (1) and the machining cycle (2). The programming sequence must be observed: The contour will be created first and the machining cycle afterwards (e.g.: path milling). The control system links both program parts with a symbolic bracket (3) in the cycle list.

Change contour

Change contour element

- Open the program to be processed.
- Use the cursor to select the program block in which the contour should be changed. The individual contour elements will be listed.
- Position cursor at the point to insert or change.
- Use the softkey to select the desired element.
- Enter parameter in the input screen or delete the element and select a new element.
- Press Softkey. The desired contour element will be inserted or changed on the contour.



Change
selection

✓
Accept

Delete contour element

- Open the program to be processed.
- Position cursor on the contour element that should be deleted.
- Press Softkey.
- Press Softkey.

Delete
element

✓
Delete





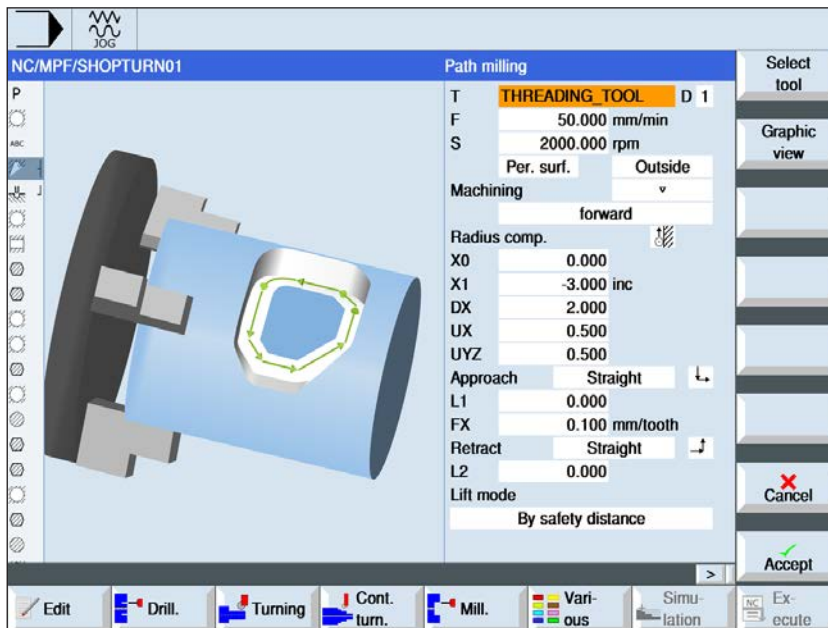

Path milling



The "Select" button gives you the option to change parameters and/or units. To do this move the cursor to the appropriate field and press button.

Parameter	Description	Unit
T	Tool name	
D	Cutting number	
F	Feed	mm/min mm/tooth
S / V	Spindle speed or constant cutting speed	rpm m/min
Machining surface	<ul style="list-style-type: none"> • Side • Front 	
Position	<ul style="list-style-type: none"> • internal • external 	
Machining	<ul style="list-style-type: none"> • ▾ Roughing • ▾ ▾ Finishing • Chamfering 	
Machining direction	<ul style="list-style-type: none"> • forwards: The machining takes place in the programmed contour direction. 	
Radius correction	<ul style="list-style-type: none"> • left (machining left from the contour) • right (machining right from the contour) • off <p>A programmed contour can also be programmed on the centre point path. In this, movement in or out is possible in a straight line or vertically. Moving in and out vertically can also, for example, be used with closed contours.</p>	
X0, Z0	Reference point X or Z (X0 for side, Z0 for front)	mm
X1, Z1	Final depth (absolute) or final depth relative to X0 or Z0 (incremental) (only if ▾, or ▾ ▾ ▾)	mm

Parameter	Description	Unit
DZ, DX	maximum depth infeed (only if ▽, or ▽ ▽ ▽)	mm
UZ, UX	Finishing pass plane (only when ▽)	mm
FS	Bevel width for chamfering (only for chamfering)	mm
ZFS	Tool tip plunge depth (absolute or incremental) (only for chamfer)	mm
UXY UYZ	Finishing pass plane (for front) Finishing pass plane (only if ▽)	mm
Approach mode	Approach mode level <ul style="list-style-type: none"> • Straight line: Slope in space • Quadrant: Part of a spiral (only when path milling left and right of the contour) • Semi-circle: Part of a spiral (only when path milling left and right of the contour) • Vertical: Vertical to path (only for path milling on the center point path) 	
Approach strategy	<ul style="list-style-type: none"> •  axially (only when approaching "quadrant, semi-circle or straight line") •  three-dimensionally (only when approaching "quadrant, semi-circle or straight line") 	
R1	Approach radius (only when approaching "quadrant or semi-circle")	mm
L1	Approach length (only for "Straight line" approach)	mm
Withdraw mode	Withdraw mode plane <ul style="list-style-type: none"> • Straight line: Slope in space • Quadrant: Part of a spiral (only when path milling left and right of the contour) • Semi-circle: Part of a spiral (only when path milling left and right of the contour) 	
Withdrawal strategy	<ul style="list-style-type: none"> •  axially •  three-dimensionally 	
R2	Withdrawal radius (only when approaching "quadrant or semi-circle")	mm
L2	Withdrawal length (only for "straight line" withdrawal)	mm
Lift mode	When several depth infeeds are required, indicate retraction height to which the tool should pull back between the individual infeeds (during transition from end of the contour to the start). Lift mode before renewed infeed <ul style="list-style-type: none"> • no retraction • on RP ...retraction plane • Z0 (for side) X0 (for front) + safety distance • by safety distance 	

Approach and withdrawal mode

The contour can be approached or withdrawn from in a quarter circle, semi-circle or straight line.

- For the quadrant or semi-circle the radius of the mill center point must be indicated.
- With straight lines the distance from the external edge of the mill to the contour start point or contour end point must be indicated.

Mixed programming is also possible, e.g. approach in quarter circle.

Withdraw in semi-circle.

Strategy for approach/withdrawal

You can selected between planar approach/withdrawal and three-dimensional approach/withdrawal:

- Planar approach:
first the depth and then the machining plane will be approached.
- Three-dimensional approach:
the depth and machining plane will be approached simultaneously.
- Withdrawal takes place in the reverse order.

Mixed programming is possible, e.g. approaching in the machining plane, withdrawing three-dimensionally.

Path milling on the center point path

A programmed contour can also be processed on the centre point path, if the radius correction was switched off. In this, movement in or out is possible in a straight line or vertically. Vertical approach/withdrawal can be used, for example, with closed contours.

Cycle description**1 Path milling (roughing)**

The contour will be processed taking the indicated approach and withdrawal strategies into account.

2 Path milling (finishing)

If a finishing pass was programmed during roughing, the contour will be processed again.

3 Path milling (chamfering)

If an edge breach is anticipated, the workpiece will be milled with a special tool.

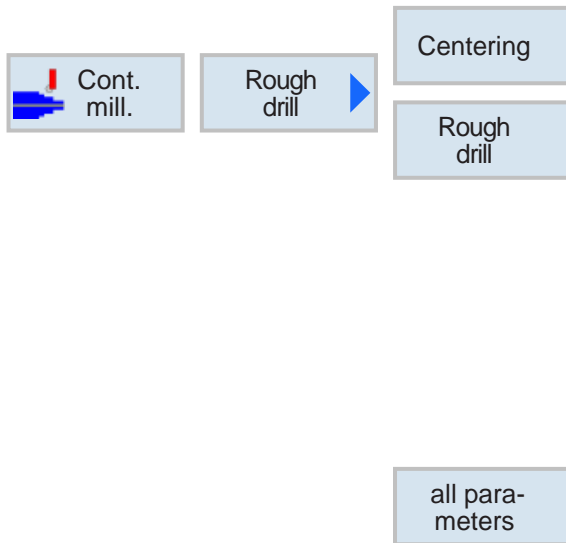

Pre-drill contour pocket

Alongside pre-drilling the centering option also exists with this cycle. For this centering or pre-drilling programs generated from the cycle are called up.

During clearing of contour pockets, when a mill cannot plunge in the center, it is necessary to pre-drill. The number and the positions of the pre-drillings required depends on special circumstances such as e.g. type of contours, tool, plane infeed, finishing pass.

Use this softkey to enter additional parameters. Additional parameters are helpful if several pockets are being drilled and unnecessary tool changes should be avoided. In this way all pockets can initially be pre-drilled and then cleared. The parameters must correspond to the parameters of the associated clearing step.

Programming

- 1 Contour pocket 1
- 2 Centering
- 3 Contour pocket 2
- 4 Centering
- 5 Contour pocket 1
- 6 Preliminary drilling
- 7 Contour pocket 2
- 8 Preliminary drilling
- 9 Contour pocket 1
- 10 Clearing
- 11 Contour pocket 2
- 12 Clearing

When a pocket is being fully machined (centering, pre-drilling and clearing directly after one another), and the additional parameters for centering/pre-drilling have not been filled out, the cycle applies these parameter values from the Clearing machining step (roughing).



Centering

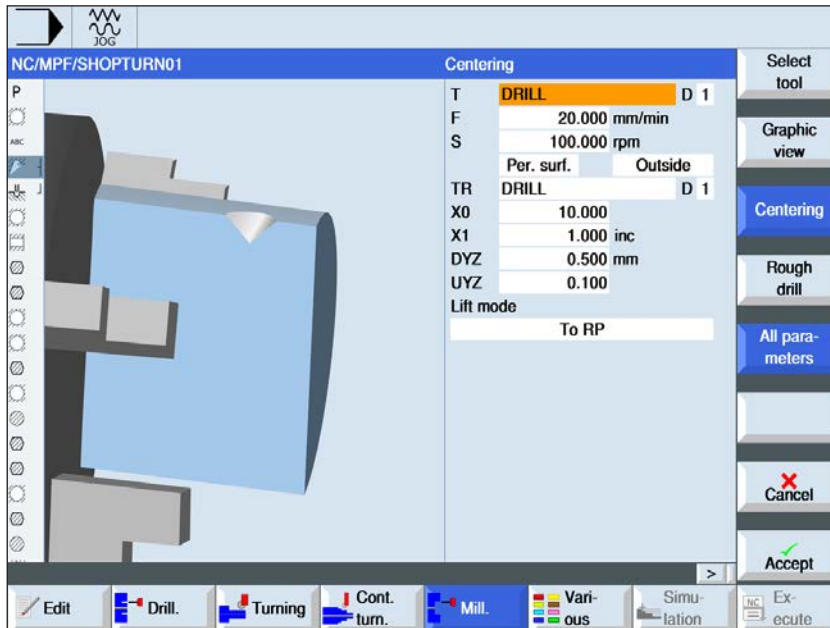

The "Select" button gives you the option to change parameters and/or units. To do this move the cursor to the appropriate field and press button.

all parameters

Use this softkey to enter additional parameters. Additional parameters are helpful if several pockets are being drilled and unnecessary tool changes should be avoided. In this way all pockets can initially be pre-drilled and then cleared.

Parameter	Description	Unit
T	Tool name	
D	Cutting number	
F	Feed	mm/min mm/tooth
S / V	Spindle speed or constant cutting speed	rpm m/min
Machining surface	<ul style="list-style-type: none"> • Side • Front 	
Position	<ul style="list-style-type: none"> • behind • in front 	
TR	Reference tool. Tool used in the "clearing" machining step. Used to determine the plunge position.	
X0, Z0	Reference point X or Z (X for side, Z for front)	mm
X1, Z1	Final depth (absolute) or final depth relative to X0 or Z0 (incremental) (X0 for side, Z0 for front)	mm

Parameter	Description	Unit
DXY DYZ	<ul style="list-style-type: none"> • maximum plane infeed (for machining the front surface) • maximum plane infeed as percentage of the mill diameter (for machining the front surface) 	mm %
UXY UYZ	Finishing pass plane (for front) Finishing pass plane (for side)	
Lift mode	If several plunge points are required during machining, the retraction height can be programmed. <ul style="list-style-type: none"> • on the retraction plane • Z0 + safety distance During the transition to the next plunge point the tool pulls back to this height. If there are no elements larger than Z0 in the pocket area, Z0 + safety distance can be programmed as lift mode.	mm



Preliminary drilling



The "Select" button gives you the option to change parameters and/or units. To do this move the cursor to the appropriate field and press button.

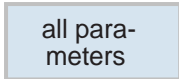
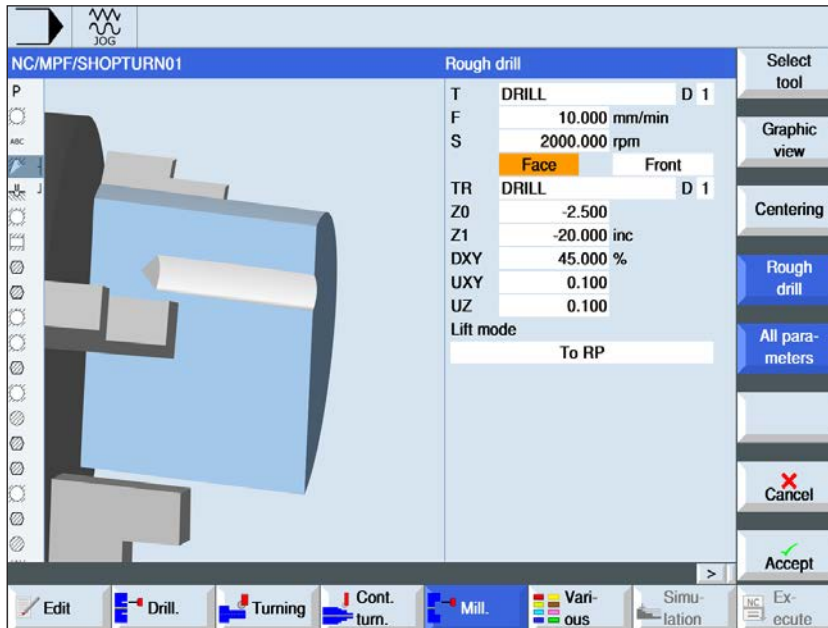

Use this softkey to enter additional parameters. Additional parameters are helpful if several pockets are being drilled and unnecessary tool changes should be avoided. In this way all pockets can initially be pre-drilled and then cleared.

Parameter	Description	Unit
T	Tool name	
D	Cutting number	
F	Feed	mm/min mm/tooth
S / V	Spindle speed or constant cutting speed	rpm m/min
TR	Reference tool. Tool used in the "clearing" machining step. Used to determine the plunge position.	
Machining surface	<ul style="list-style-type: none"> • Side • Front 	
Position	<ul style="list-style-type: none"> • external • internal 	
Z0, X0	Reference point X or Z (X for side, Z for front)	mm
X1, Z1	Pocket depth (absolute) or depth relative to X0 or Z0 (incremental) (X0 for side, Z0 for front)	mm

Parameter	Description	Unit
DXY DYZ	<ul style="list-style-type: none"> • maximum plane infeed (for machining the front surface) • maximum plane infeed as percentage of the mill diameter (for machining the front surface) 	mm %
UXY UXZ	Finishing pass plane (for front) Finishing pass plane (for side)	mm
UX UZ	Depth finishing pass (for front) Depth finishing pass (for side)	mm
Lift mode	If several plunge points are required during machining, the retraction height can be programmed. <ul style="list-style-type: none"> • on the retraction plane • Z0 + safety distance During the transition to the next plunge point the tool pulls back to this height. If there are no elements larger than Z0 in the pocket area, Z0 + safety distance can be programmed as lift mode.	mm



Mill pocket

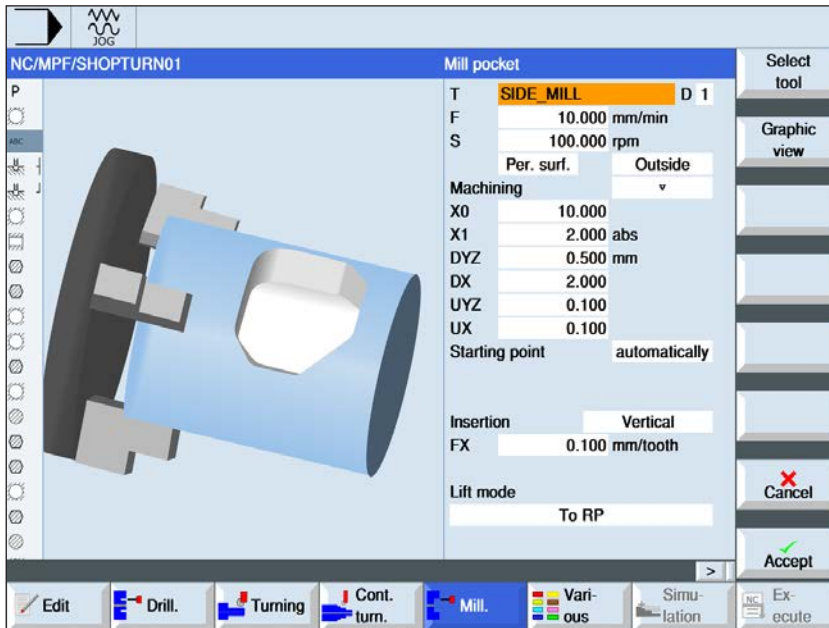

The "Select" button gives you the option to change parameters and/or units. To do this move the cursor to the appropriate field and press button.

Parameter	Description	Unit
T	Tool name	
D	Cutting number	
F	Feed	mm/min mm/tooth
S / V	Spindle speed or constant cutting speed	rpm m/min
Machining	<ul style="list-style-type: none"> ▾ Roughing ▾ ▾ ▾ Floor finishing ▾ ▾ ▾ Edge finishing Chamfering 	
Machining surface	<ul style="list-style-type: none"> Side Front 	
Position	<ul style="list-style-type: none"> external internal 	
X0, Z0	Reference point X or Z (X for side, Z for front)	mm
X1, Z1	Pocket depth (absolute) or depth relative to X0 or Z0 (incremental) (only if ▾, ▾ ▾ ▾ bottom, or ▾ ▾ ▾ edge)	mm
DX DYZ	<ul style="list-style-type: none"> maximum plane infeed (for machining the front surface) maximum plane infeed as percentage of the mill diameter (for machining the side surface) (only if ▾, or ▾ ▾ ▾ floor)	mm %
DZ DX	maximum depth infeed (for machining the front surface) maximum depth infeed (for machining the side surface) (only if ▾, or ▾ ▾ ▾ edge)	mm

Parameter	Description	Unit
UXY UYZ	Finishing pass plane (for machining front surface) Finishing pass plane (for machining side surface) (only if ▽, ▽ ▽ ▽ floor, or ▽ ▽ ▽ edge)	mm
UZ UX	Depth finishing pass (for machining front surface) Depth finishing pass (for machining side surface) (only if ▽, or ▽ ▽ ▽ floor)	mm
Start point	<ul style="list-style-type: none"> manually Start point will be specified manually automatically Start point will be calculated automatically (only if ▽, or ▽ ▽ ▽ floor) 	
XS YS	Coordinates of the start point in X and Y (only with start point "manual")	
Plunging	<p>(only ▽, or ▽ ▽ ▽ bottom)</p> <ul style="list-style-type: none"> vertical: Plunge vertically on pocket center: The calculated current infeed depth will be executed in the pocket center in one block. With this setting the milling cutting tool must cut via the center or it must be pre-drilled. helical: Plunging on spiral path: The center of the milling cutter moves on the spiral path defined by the radius and the depth per revolution (helical path). Once the depth for the infeed has been reached, another full circle will be executed, in order to overcome the angular path of the plunge. swinging: Plunge swinging on the center axis of the longitudinal groove: The center of the milling cutter swings on a straight line back and forth till the depth infeed is reached. Once the depth has been reached, the path will be executed again without the depth infeed, in order to overcome the angular path of the plunge. 	
FX FZ	Depth infeed (for machining side surface) Depth infeed (for machining front surface) (only if plunging vertically and ▽ or ▽ ▽ ▽ floor)	mm/min mm/tooth
EP	Maximum pitch of the helix - (only with helical plunging)	mm/rev
ER	Radius of the helix (only with helical plunging) The radius may not be larger than the milling cutting tool radius, as otherwise material remains.	mm
EW	Maximum plunge angle (only with swinging plunging)	degrees
Lift mode before renewed infeed	<p>If several plunge points are required during machining, the retraction height can be programmed.</p> <ul style="list-style-type: none"> on the retraction plane Z0 + safety distance <p>During the transition to the next plunge point the tool pulls back to this height. If there are no elements larger than Z0 in the pocket area, Z0 + safety distance can be programmed as lift mode. (only if ▽, ▽ ▽ ▽ bottom, or ▽ ▽ ▽ edge)</p>	mm
FS	Bevel width for chamfering (only for chamfering)	mm
ZFS	Tool tip plunge depth (only when chamfering)	mm

**Instructions:**

With manual input the start point can also be outside the pocket. This can, for example, be sensible when clearing a pocket that is open at the side. The machining then begins without plunging with a straight line movement into the open side of the pocket.

Contours for pockets or islands

Contours for pockets or islands must be closed, i.e. start and end point of the contour are identical. Pockets can be milled that are contained inside one or more islands. The islands may also be partly outside the pocket or intersect with one another. The first indicated contour will be interpreted as a pocket contour, all the others as islands.

Calculate start point automatically / enter manually

The optimal point for plunging can be calculated automatically using "Start point automatic". "Start point manual" defines the plunge point in the parameter screen. If it emerges from the pocket contour, the islands and the milling cutting tool diameter that there must be plunging at various points, the manual input defines only the first plunge point. The others will be calculated automatically.

Machining

The machining of contour pockets with islands/raw part contour with spigots will be programmed as follows:

Example:

1. Enter pocket contour/unmachined part contour
2. Enter island/spigot contour
3. Centering (only possible with pocket contour)
4. Preliminary drilling (only possible with pocket contour)
5. Clear/process pocket/spigot - roughing
6. Clear/machine remaining material - roughing.



Mill spigot

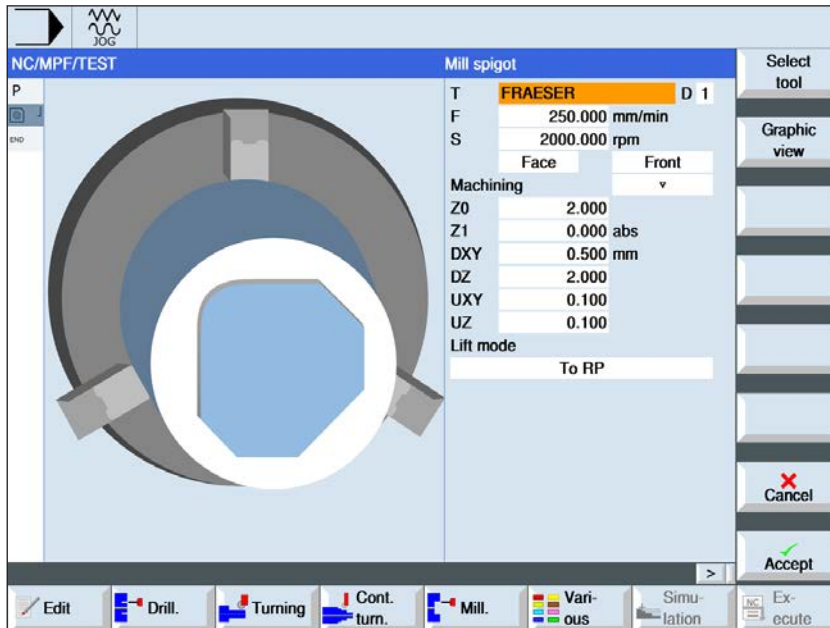

The "Select" button gives you the option to change parameters and/or units. To do this move the cursor to the appropriate field and press button.

Parameter	Description	Unit
T	Tool name	
D	Cutting number	
F	Feed	mm/min mm/tooth
S / V	Spindle speed or constant cutting speed	rpm m/min
Machining surface	<ul style="list-style-type: none"> • Face 	
Position	<ul style="list-style-type: none"> • front 	
Machining	<ul style="list-style-type: none"> • ▾ Roughing • ▾ ▾ ▾ Floor finishing • ▾ ▾ ▾ Edge finishing • Chamfer 	
Z0	Reference point Z	mm
Z1	Pocket depth (absolute) or depth relative to Z0 (incremental) (only if ▾, ▾ ▾ ▾ bottom, or ▾ ▾ ▾ edge)	mm
DXY	<ul style="list-style-type: none"> • maximum plane infeed (for machining the front surface) (only if ▾, or ▾ ▾ ▾ floor) 	mm %
DZ	maximum depth infeed (for machining the front surface) (only if ▾, or ▾ ▾ ▾ edge)	mm

Parameter	Description	Unit
UXY	Finishing pass plane (for machining front surface) (only if ▽ , ▽ ▽ ▽ floor, or ▽ ▽ ▽ edge)	mm
UZ	Depth finishing pass (for machining front surface) (only if ▽ , or ▽ ▽ ▽ floor)	mm
Lift mode before renewed infeed	If several plunge points are required during machining, the retraction height can be programmed. <ul style="list-style-type: none"> • on the retraction plane • Z0 + safety distance During the transition to the next plunge point the tool pulls back to this height. If there are no elements larger than Z0 in the pocket area, Z0 + safety distance can be programmed as lift mode. (only if ▽ , ▽ ▽ ▽ floor, or ▽ ▽ ▽ edge)	mm
FS	Bevel width for chamfering (only for chamfering)	mm
ZFS	Tooltip plunging depth (for machining front surface) (absolute or incremental) (only for chamfer)	mm

Cycle description

Chip crushing

- 1 The control system positions the tool in the spindle axis in rapid traverse (G0) to the safety distance above the reference point. The start point will be calculated by the cycle.
- 2 The tool first feeds in to the machining depth and then approaches the spigot contour sideways in the quadrant with machining feed.
- 3 The spigot will be cleared in parallel with the contour from outside to in. The direction will be defined by the machining direction of rotation (up-cut milling or down-cut milling).
- 4 Once the spigot in one plane has been cleared, the tool leaves the contour in the quadrant and the infeed to the next machining depth takes place.
- 5 The spigot will again be approached in the quadrant cleared in parallel with the contour from outside to in.
- 6 Steps 4 to 5 will be repeated until the programmed spigot depth is reached.
- 7 The tool moves back to the safety distance in rapid traverse (G0).

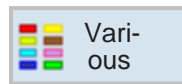

Various

- Settings
- Transformations
- Sub-routine
- Repeat program
- Bar loading interface

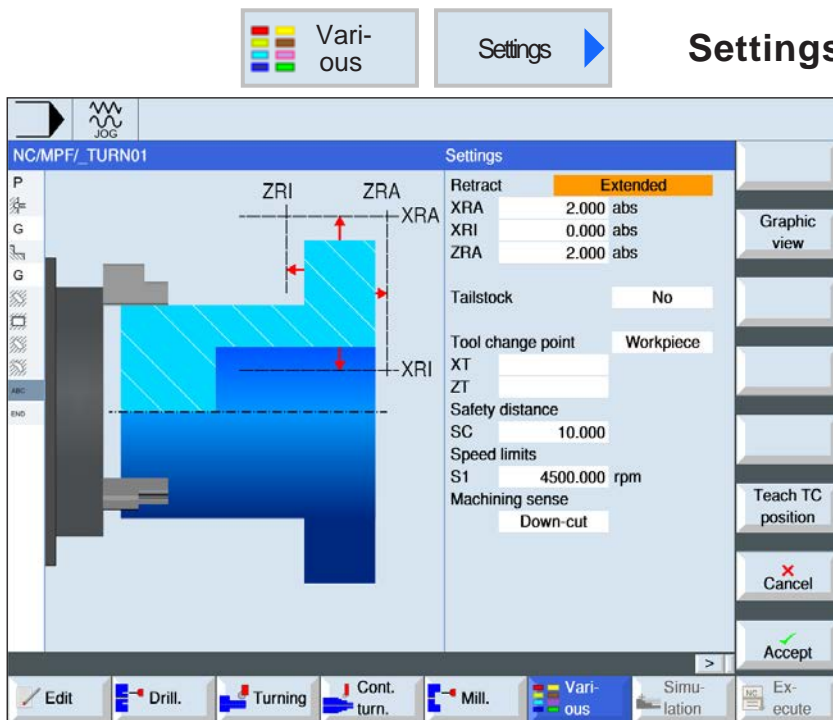

The "Select" button gives you the option to change parameters and/or units. To do this move the cursor to the appropriate field and press button.

Parameter	Description	Unit
Dates for	Here, you decide the spindle selection for machining the dates - (only available if the machine has a counter-spindle) <ul style="list-style-type: none"> • Main spindle Record for the main spindle • Counter-spindle Record for the main spindle • Main and counter-spindles All values for main and counter-spindles are stored in a record 	
Retract	Lift mode: <ul style="list-style-type: none"> • single • extended • all • blank 	mm
XRO	Retraction plane X outside Ø (absolute) or retraction plane X relative to XA (incremental)	mm
XRI	Retraction plane X inside Ø (absolute) or retraction plane X relative to XI (incremental) (only for withdrawal "extended" and "all")	mm
ZRO	Withdrawal plane Z front (absolute) or Withdrawal plane Z relative to ZA (incremental)	mm
ZRI	Retraction plane Z behind (only for withdrawal "all")	mm

Parameter	Description	Unit
Tailstock	yes <ul style="list-style-type: none"> • Tailstock is shown for simulation/signature • When approaching/withdrawing, the withdrawal logic is taken into account no	
XRR	Retraction plane - (only if tailstock "yes")	mm
Tool change point	Tool change point <ul style="list-style-type: none"> • TCS (Tool coordinates system) • MCS (Machine coordinate system) • blank 	
XT	Tool change point X	mm
ZT	Tool change point Z	mm
SC	Safety distance (incr.) Acts relative to the reference point. The direction, in which the safety distance acts, is determined by the cycle automatically.	mm
S1	Maximum main spindle speed	rpm
machining direction of rotation	Milling direction <ul style="list-style-type: none"> • Up cut • Downcut • blank 	

**Information:**

All parameters defined in the program header (besides the data of the raw piece) can be changed at any point in the program. The settings in the program header are effective until they are changed.

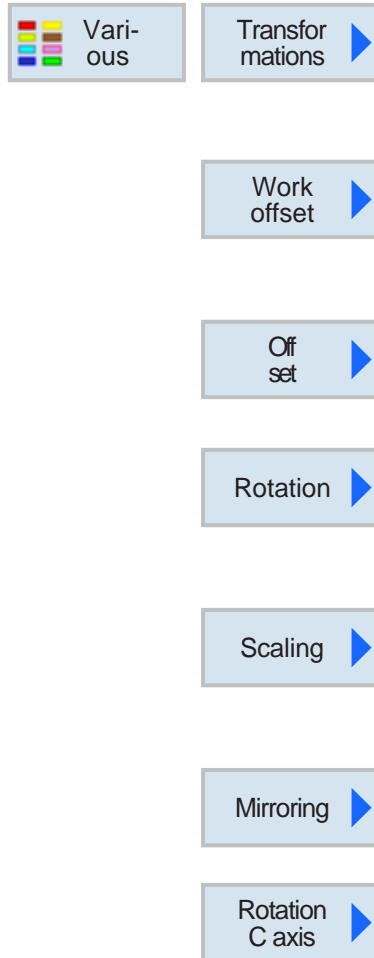

Transformations

This cycle group is used for zero point offset (NPV), the workpiece zero point (W), mirroring and rotating. The following options exist:

- Zero point offset
Zero point offsets (G54, ...) can be called from any program (see Chapter A "Zero point offset", as well as Chapter C "Zero point offset").
- Offset
An offset from the zero point offset can be programmed for every axis.
- Rotation
Every axis can be rotated by a defined angle. A positive angle corresponds to a rotation in the counter-clockwise direction.
- Scaling
For scaling in X/Y/Z a scale factor can be entered. The programmed coordinates will then be multiplied with this factor.
- Mirroring
The axis to be mirrored can be selected.
- C-axis rotation
You can select by which angle the C-axis should be rotated.

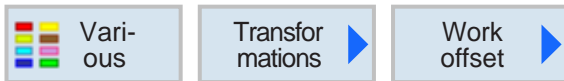

Zero point offset

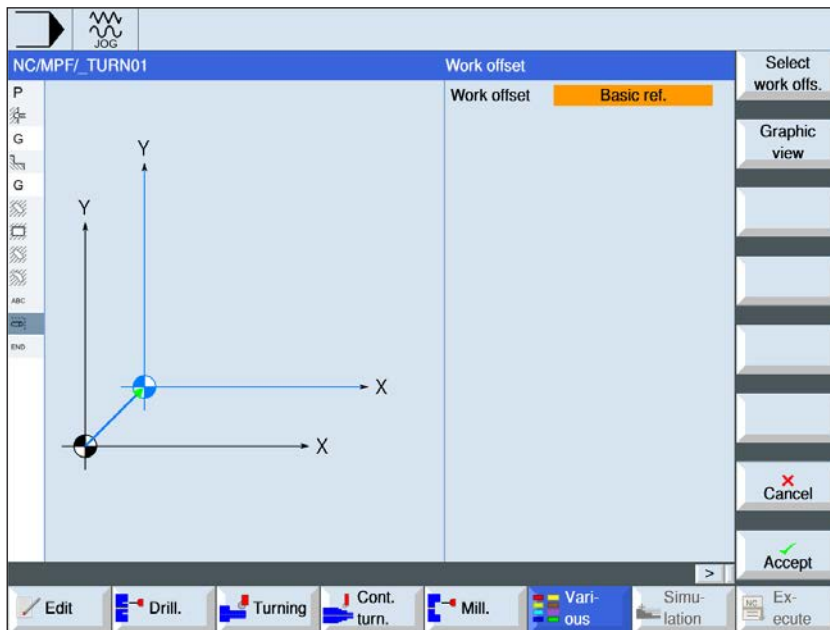

The "Select" button gives you the option to change parameters and/or units. To do this move the cursor to the appropriate field and press button.

Parameter	Description
Zero point offset	<ul style="list-style-type: none"> • Base reference • G54 • G55 • G...

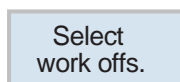

Select zero point offset

- 1 Switch to the zero point table with the softkey.
- 2 Select zero point offset (see Chapter A "Zero point offset").
- 3 Switch back to the cycle programming with the softkey.

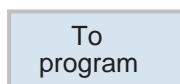

Various

 Transformations

 Off set

Offset

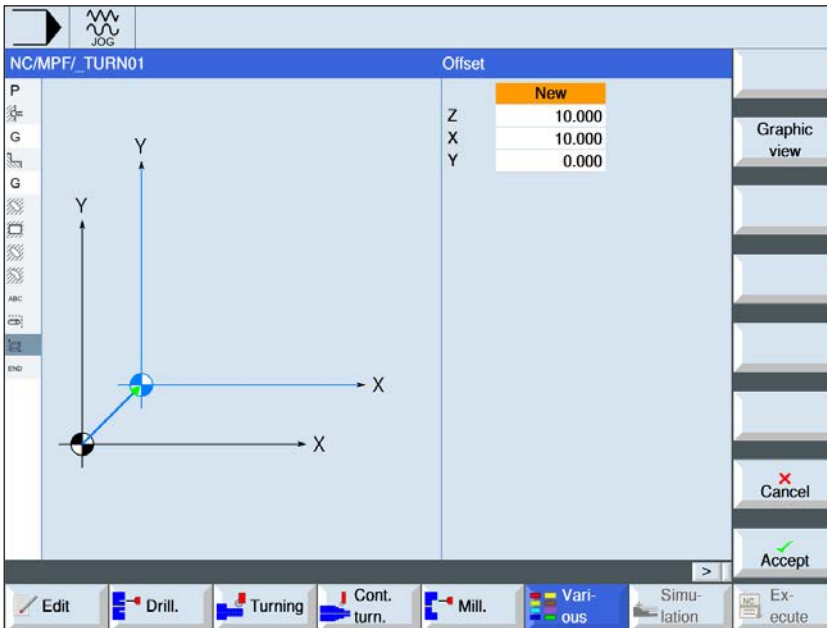

The "Select" button gives you the option to change parameters and/or units. To do this move the cursor to the appropriate field and press button.

Parameter	Description	Unit
Offset	<ul style="list-style-type: none"> • new new offset • additive additive offset 	
Z X Y	Offset in Z,X,Z	mm

Vari-ous

 Transfor-mations ▶

 Rotation ▶

Rotation

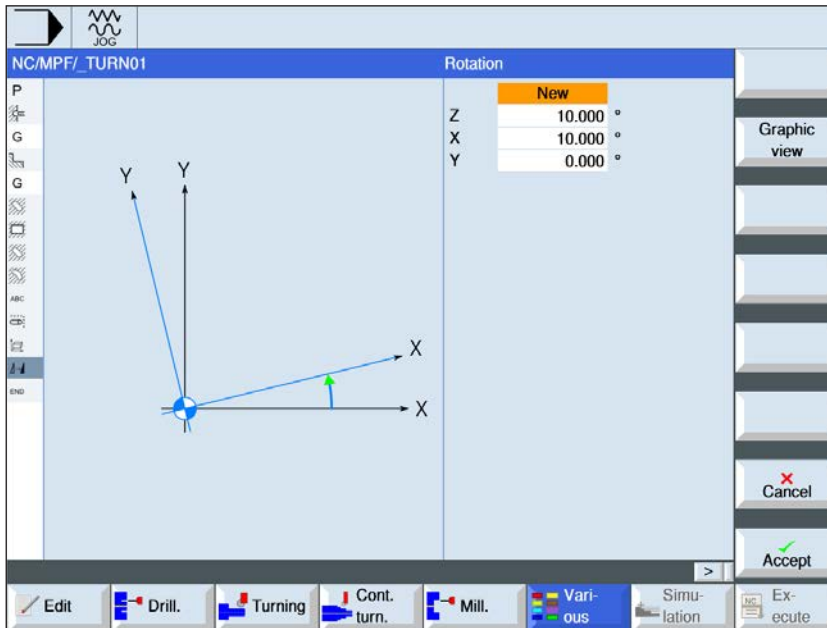

The "Select" button gives you the option to change parameters and/or units. To do this move the cursor to the appropriate field and press button.

Parameter	Description	Unit
Rotation	<ul style="list-style-type: none"> • new New rotation • additive additive Rotation 	
Z X Y	Rotation in Z,X,Y	degrees

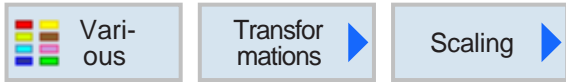

Scaling

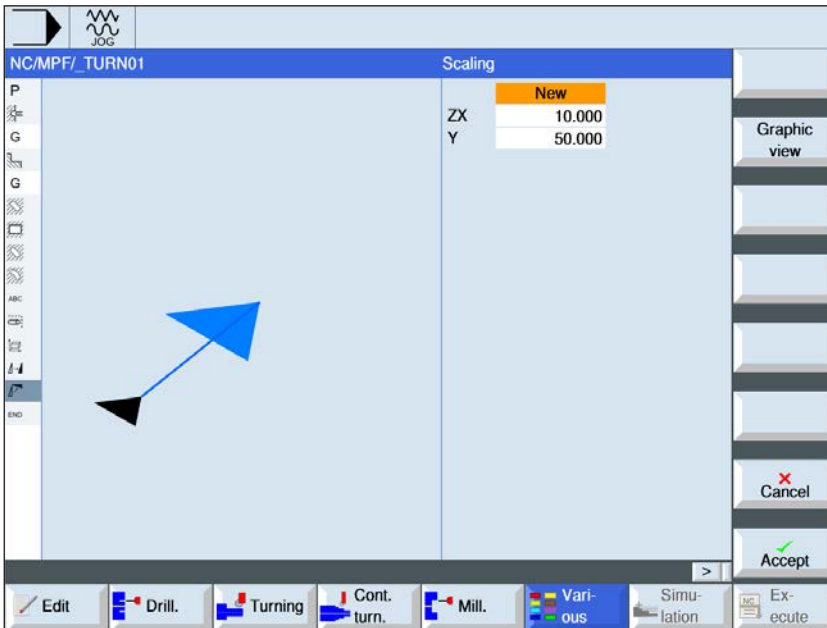

The "Select" button gives you the option to change parameters and/or units. To do this move the cursor to the appropriate field and press button.

Parameter	Description	Unit
Scaling	<ul style="list-style-type: none"> • new • new scaling • additive • additive scaling 	
ZX	Scale factor ZX	
Y	Scale factor Y	

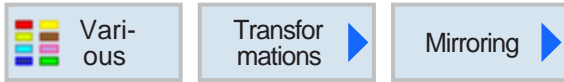

Mirroring

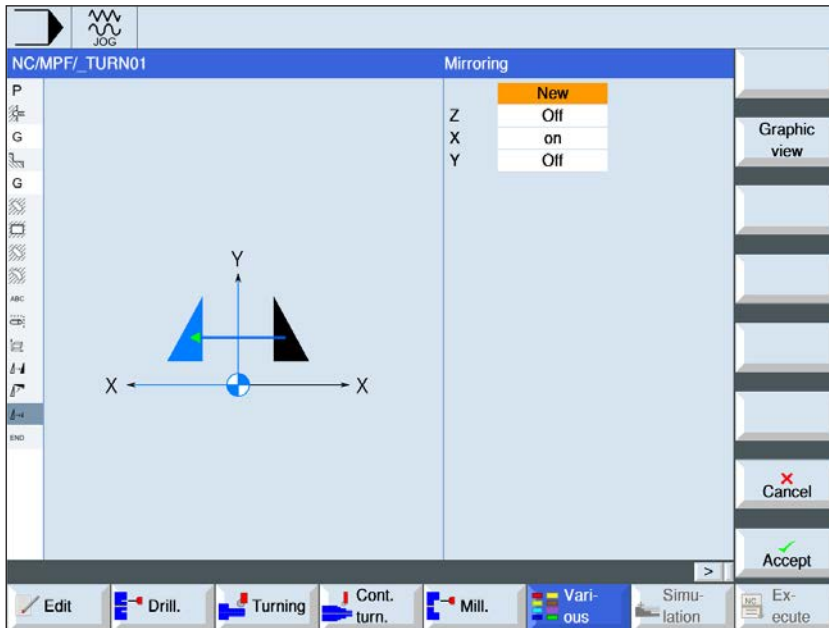

The "Select" button gives you the option to change parameters and/or units. To do this move the cursor to the appropriate field and press button.

Parameter	Description	Unit
Mirroring	<ul style="list-style-type: none"> • new • new mirroring • additive • additive mirroring 	
Z X Y	Mirroring in Z,X,Y on/off	

Instructions:

When mirroring around only one axis the tool's direction of machining changes (up-cut milling/down-cut milling).

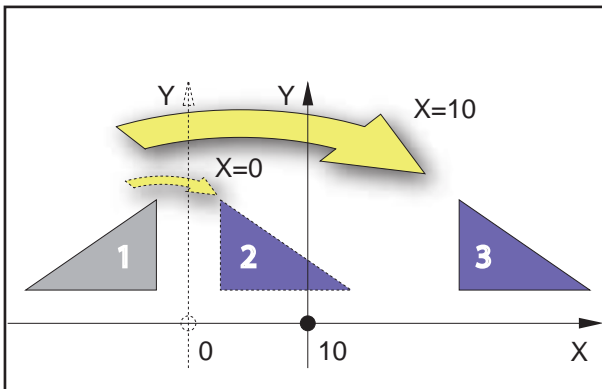

Mirror around a vertical axis

Example

The result of the mirroring is dependent on the situation of the axis:

- Contour 2 is the result of a mirroring of Contour 1 around the vertical axis with the coordinate X=0.
- Contour 3 is the result of a mirroring of Contour 1 around the vertical axis with the coordinate X=10.

C-axis rotation

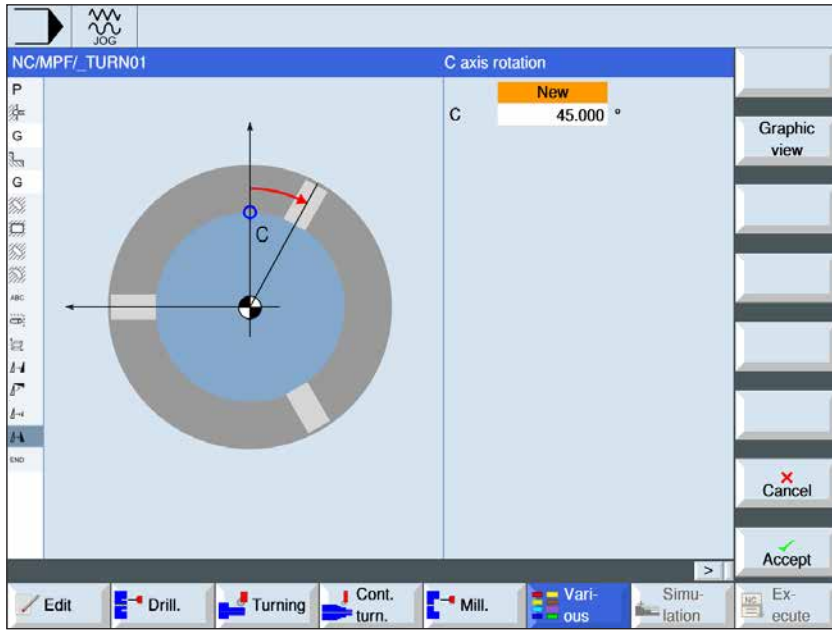

The "Select" button gives you the option to change parameters and/or units. To do this move the cursor to the appropriate field and press button.

Parameter	Description	Unit
Mirroring	<ul style="list-style-type: none"> • new • new rotation • additive • additive rotation 	
C	C rotation	degrees



Call up sub-routine

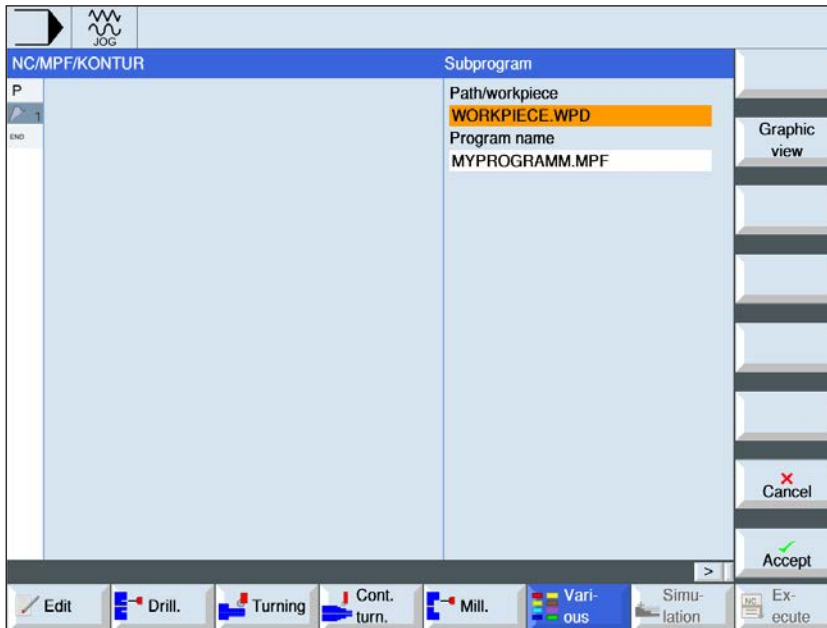

If the desired sub-program is not in the same directory as the main program, the sub-program's path must be indicated.

Parameter	Description
Path/workpiece	Sub-routine's path, if the desired sub-program is not in the same directory as the main program.
Program name	Name of the sub-program that should be inserted.

If the same machining steps are required when programming various workpieces, these machining steps can be defined as a separate sub-program. This sub-program can then be invoked in arbitrary programs. This prevents the need to program the same machining steps multiple times. The control system does not distinguish between main programs and sub-programs. This means that a "normal" work step or G-code program can be called in another work step program as a sub-program. In turn, a sub-program can be called from the sub-program.

The sub-program must be stored in its own directory "XYZ" or in the directories "Teileprogramme [Part programs]", "Unterprogramme [Sub-routines]" or in a workpiece directory.

It should be noted that the ShopTurn sub-routine analyzes the settings from the sub-routine pro-

gram header when called up. These settings also remain effective once the sub-program has finished. If you want to reactivate the settings from the program header of the main program, you can perform the desired settings in the main program after calling the sub-program.

Folder and file names:

Part program: mpf.dir (main program)

Sub-routine: spf.dir (sub-routine)

Workpiece directory: wks.dir



Repeat program blocks

If specific steps need to be carried out when machining a workpiece, it is sufficient to program these steps only once. Program blocks can be repeated.

Start and end marks

The program blocks that need to be repeated must be identified with a start and end mark. These program blocks can be invoked again up to 9999 times inside a program. The marks must have different and unambiguous names. No SIEMENS programming commands must be used as the name of a mark.

Marks and repetitions can also be set later. Setting marks and repetitions is not permitted inside chained program blocks.

Instructions:

One and the same block can serve both as the end mark of a preceding program block as well as the start mark for the following program blocks.

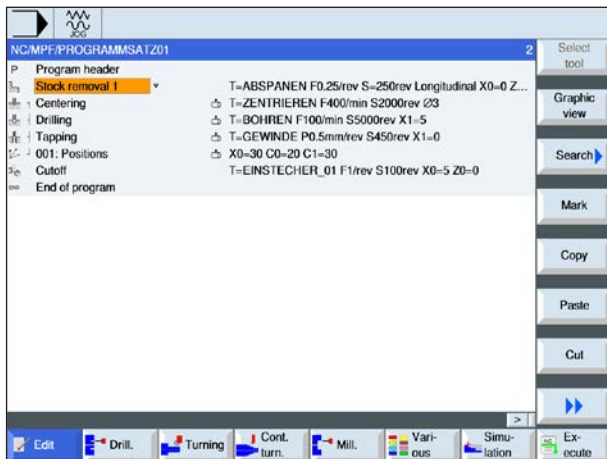

Programming a program block repetition

1 Position cursor on the program block, behind which a program block should follow that should be repeated.



2 Press softkeys.

3 Press softkey to set start mark and confirm.

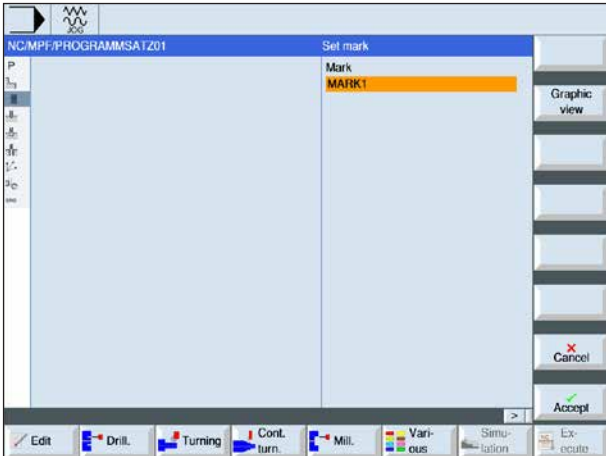

4 Give a name to the start mark (e.g.:"MARK1").

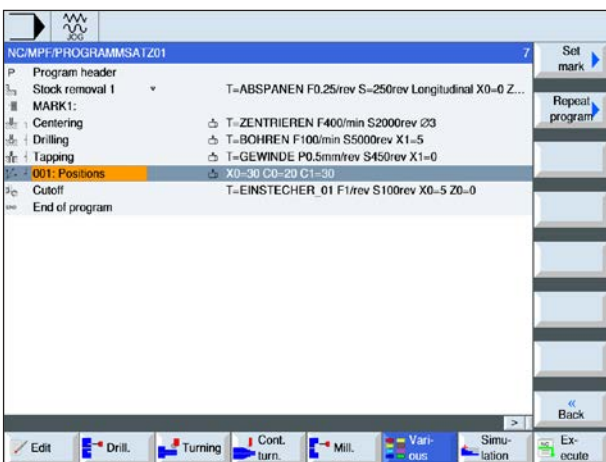

5 Position cursor on the program block behind which the end mark should be set.



6 Press softkey to set end mark and confirm.

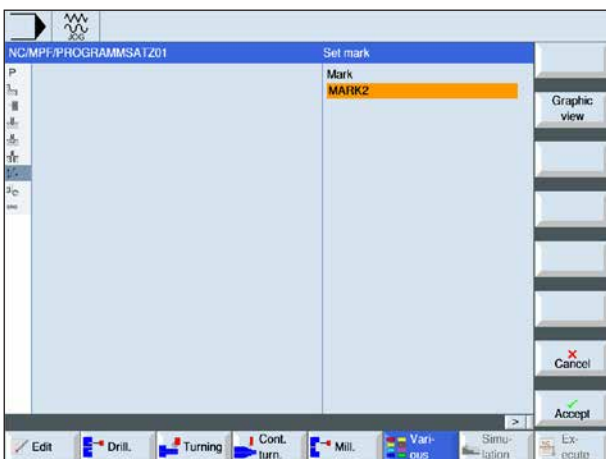

7 Give a name to the stop mark (e.g.:"MARK2").

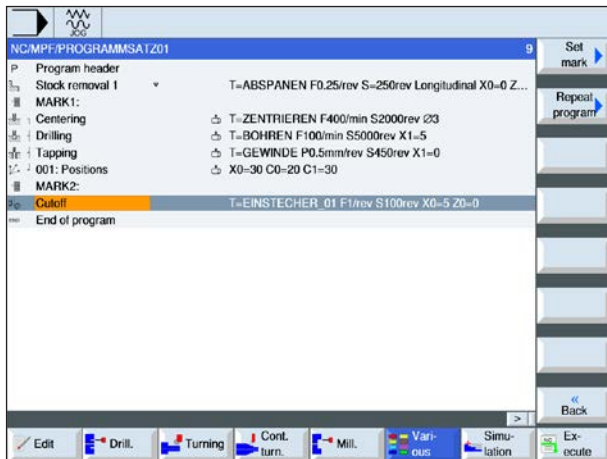

8 Position cursor on the program block behind which the repetitions should be performed.

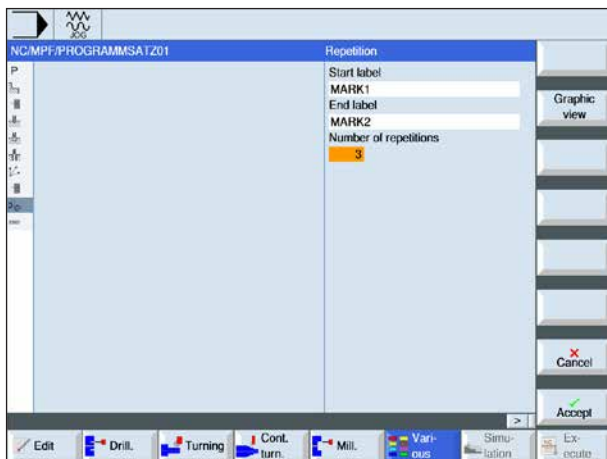
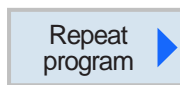

9 Press softkey to set the repetition mark. Enter the name of the start mark and the name of the end mark (e.g.: MARK1 for the start mark and MARK2 for the end mark). Define number of repetitions (e.g.: 1).

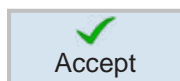

10 Press softkey to confirm.

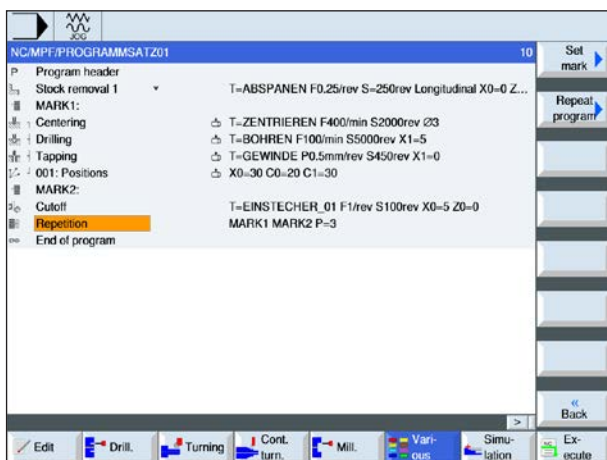

11 The program blocks between the start and end marks will be performed at the position of the repetition marks with the programmed repetitions.

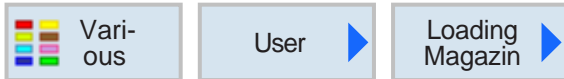

Bar Loading Interface

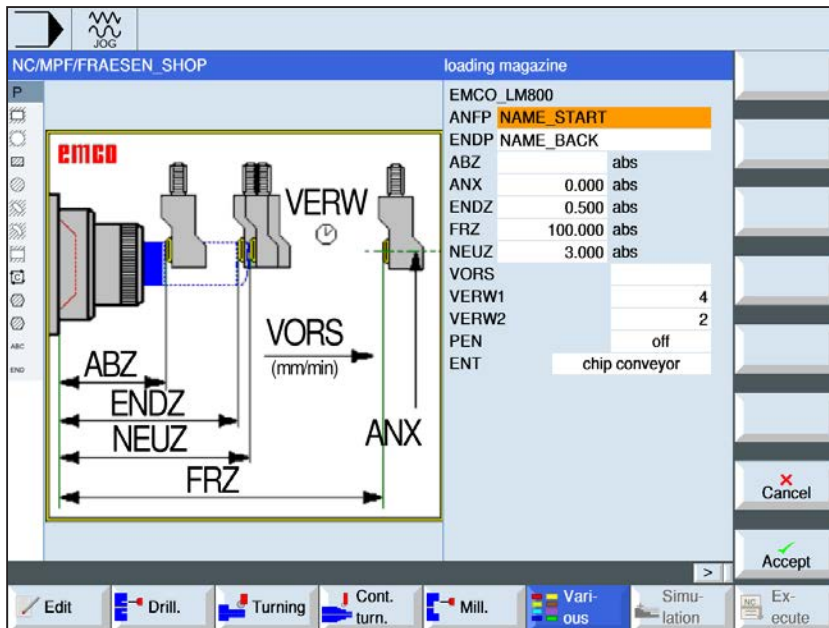

The "Select" button gives you the option to change parameters and/or units. To do this move the cursor to the appropriate field and press button.

Parameter	Description	Unit
ANFP	Name of bar beginning program	
ENDP	Name remnant machining program	
ABZ	Stop pos. before bar feed in Z (absolute)	mm
ANX	Stop position in X (absolute)	mm
ENDZ	Stop pos. after bar feed in Z (absolute)	mm
FRZ	Release pos. of stop for remnant disposal (absolute)	mm
NEUZ	Stop pos. after feed new bar (absolute)	mm
VORS	Bar feed in [mm/min] with stop	mm/min
VERW1	Dwell time part catcher forward	s
VERW2	Dwell time for remnant disposal	s
PEN	Selection oscillation of the main spindle: <ul style="list-style-type: none"> • off • on 	
ENT	Selection of the remnant disposal: <ul style="list-style-type: none"> • chip conveyor • parts catcher • remnant program 	

Note:

The option bar loading interface is only available for those machines which can be equipped with a bar loading interface.



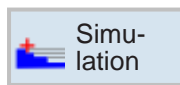

Simulation

Straight line or circular machining



- Delete
- Straight line
- Circle center
- Circle radius
- Polar

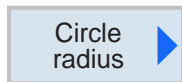
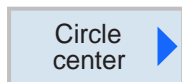
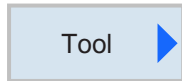

Caution:

When the tool is to move with a straight-line or circular path movement into the retraction area defined in the program header, the tool should also be moved out again. Otherwise the movements of a subsequently programmed cycle may result in collisions.

Straight line or circular machining

This cycle group is used to create straight or circular path movements. machinings can be carried out without defining a complete contour.

The following options are available for selection:

- Tool
Before a straight line or a circle is programmed, a tool must be selected and the spindle speed defined.
- Straight line
The tool moves with the programmed feed or in rapid traverse from the current position to the programmed end position.
- Kreis Circle center
The tool moves on a circular path from the current position to the programmed circle end point. The position of the circle center point must be known. The radius of the circle/curve will be calculated by entering the interpolation parameters through the control system. It can only be moved in the machining feed. Before the circular movement is made, a tool must be programmed.
- Kreis Circle radius
The tool moves on a circular path with the programmed radius from the current position to the programmed circle end point. The control system calculates the position of the circle center point. Interpolation parameters do not need to be programmed. It can only be moved in the machining feed.
- Polar
If the dimensioning of a workpiece from a central point (pole) has been carried out with radius and angle details, these can be advantageously programmed as polar coordinates. Straight lines and circles can be programmed as polar coordinates.

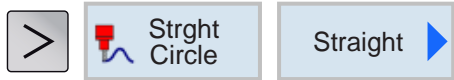

Program straight line

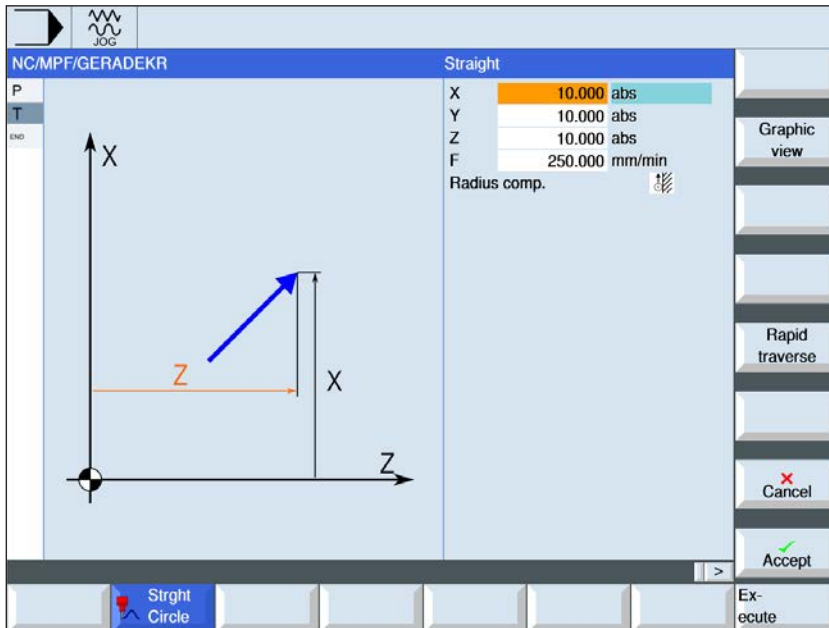

The "Select" button gives you the option to change parameters and/or units. To do this move the cursor to the appropriate field and press button.

Parameter	Description	Unit
X Y Z	Target position X,Y,Z Ø (absolute) or target position X,Y,Z relative to the last programmed position (incremental).	mm
F	machining feed	mm/min mm/rev mm/tooth
Radius correction	<ul style="list-style-type: none"> <input checked="" type="checkbox"/> left (machining left from the contour) <input checked="" type="checkbox"/> right (machining right from the contour) <input type="checkbox"/> off <input type="checkbox"/> no change in the contour 	



Programming rapid traverse

This softkey programs the feed in rapid traverse.

Instructions:

Optionally, a straight line can be drawn with radius correction. This is self-supporting (modal), i.e. the radius correction must be discarded again if you move without it. However, this can only be selected in the first program string if you have a number of consecutive straight lines with radius correction.

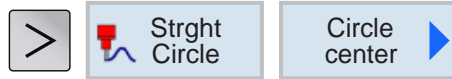

Program circle with known center point

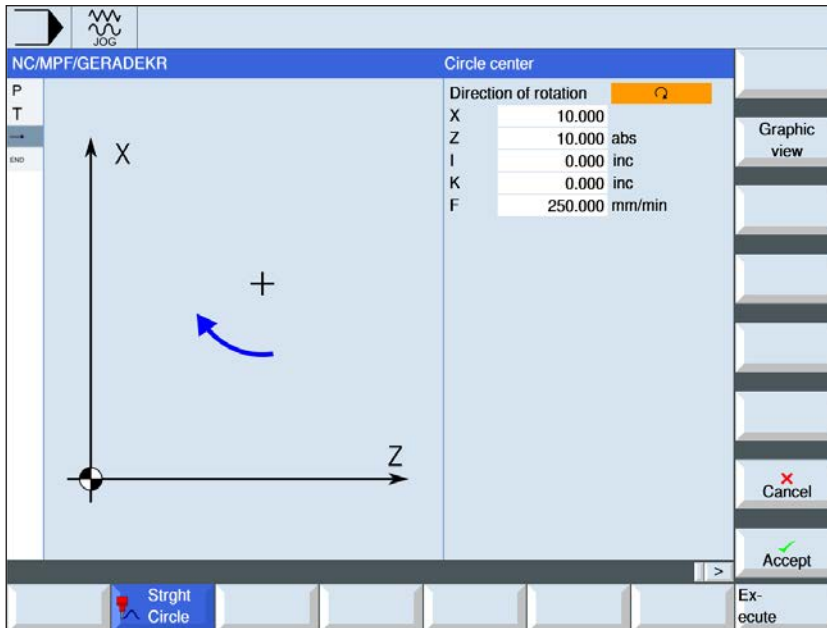

The "Select" button gives you the option to change parameters and/or units. To do this move the cursor to the appropriate field and press button.

Parameter	Description	Unit
Direction of rotation	<ul style="list-style-type: none"> Direction of rotation right Direction of rotation left <p>There will be movement from the circle start point to the circle end point in the programmed direction. This direction can be programmed in the clockwise direction or in the counter-clockwise direction.</p>	
X Z	Target position X,Z Ø (absolute) or target position X,Z relative to the last programmed position (incremental).	mm
I K	Distance circle start point to circle center point (incremental). Incremental dimension: The symbol is analyzed.	mm
F	machining feed	mm/min mm/rev mm/tooth

Instructions:

In incremental mode, note the following for target position (X, Y) and the circle start point to the circle end point:
a plane-dependent check takes place at a previously valid start point.

For XY plane (front machining)

X: I

Y: J

For: ZX plane (contour machining)

Z: K

X: I

For YZ plane (side surface machining)

Y: J

Z: K

see also section E, Plane Selection

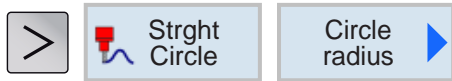

Program circle with known radius

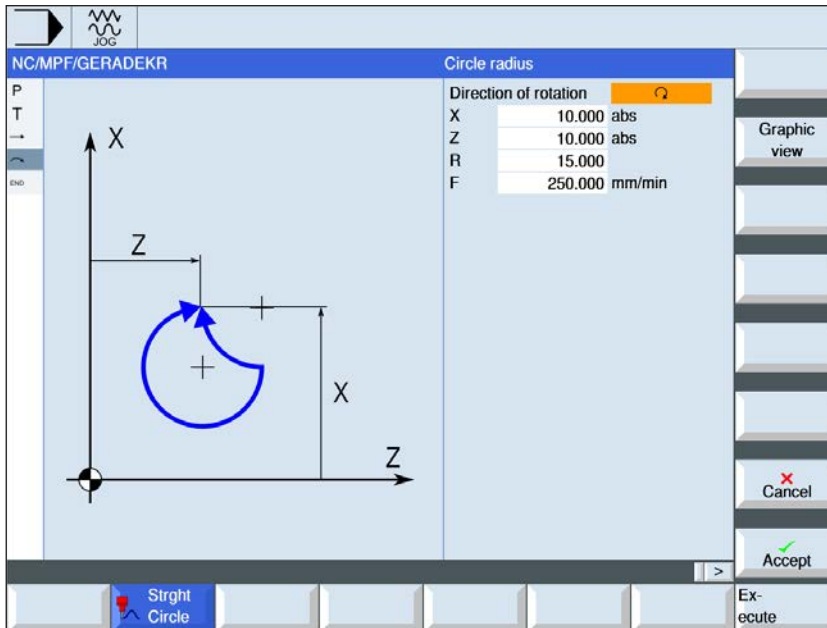

The "Select" button gives you the option to change parameters and/or units. To do this move the cursor to the appropriate field and press button.

Parameter	Description	Unit
Direction of rotation	<ul style="list-style-type: none"> Direction of rotation right Direction of rotation left There will be movement from the circle start point to the circle end point in the programmed direction. This direction can be programmed in the clockwise direction or in the counter-clockwise direction.	
X Z	Target position X,Z Ø (absolute) or target position X,Z relative to the last programmed position (incremental).	mm
R	Radius of the curve. The selection of the desired curve is made through the input of a positive or negative sign.	mm
F	Machining feed	mm/min mm/rev mm/tooth

Instructions:

Note the following when in incremental mode for the target position (X, Z): a plane-dependent check takes place at a previously valid start point.

- XY plane (front machining)
- ZX plane (contour machining)
- YZ plane (side surface machining)

see also section E, Plane Selection



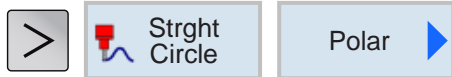

Polar coordinates

Before programming a straight line or a circle in polar coordinates the pole must be defined. This pole is the reference point of the polar coordinate system. Then the angle for the first straight line or the first circle must be programmed in absolute coordinates. The angle of the other straight lines or curves can optionally be programmed absolutely or incrementally.

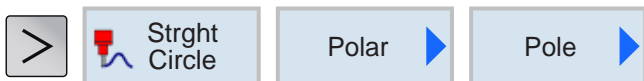

Pole

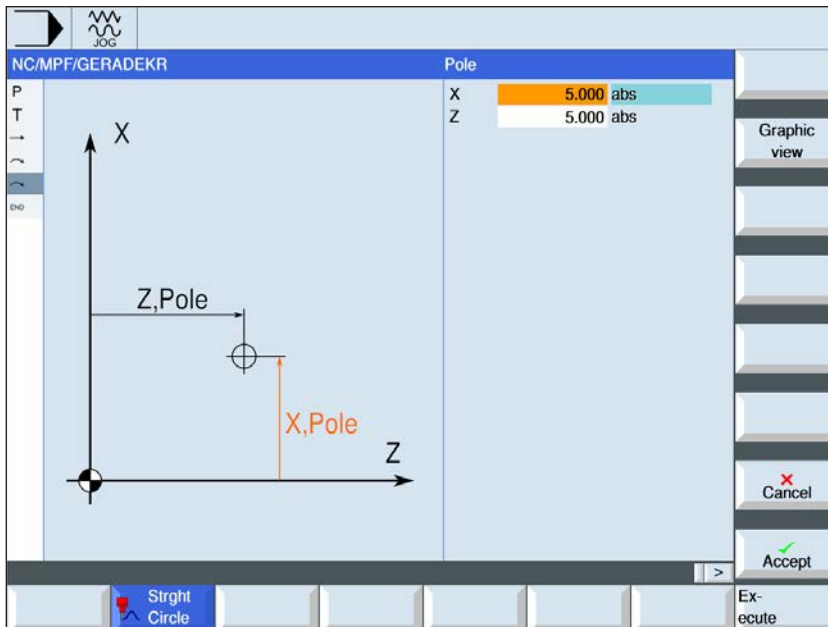

The "Select" button gives you the option to change parameters and/or units. To do this move the cursor to the appropriate field and press button.

Parameter	Description	Unit
X Z	Pole X,Z, (absolute) or pole X,Z relative to the last programmed position (incremental)	mm

Instructions:

Note the following when in incremental mode for the target position (X, Z): a plane-dependent check takes place at a previously valid start point.

- XY plane (front machining)
- ZX plane (contour machining)
- YZ plane (side surface machining)

see also section E, Plane Selection



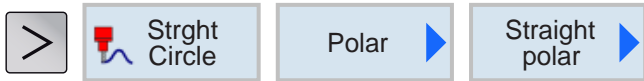

Straight line polar

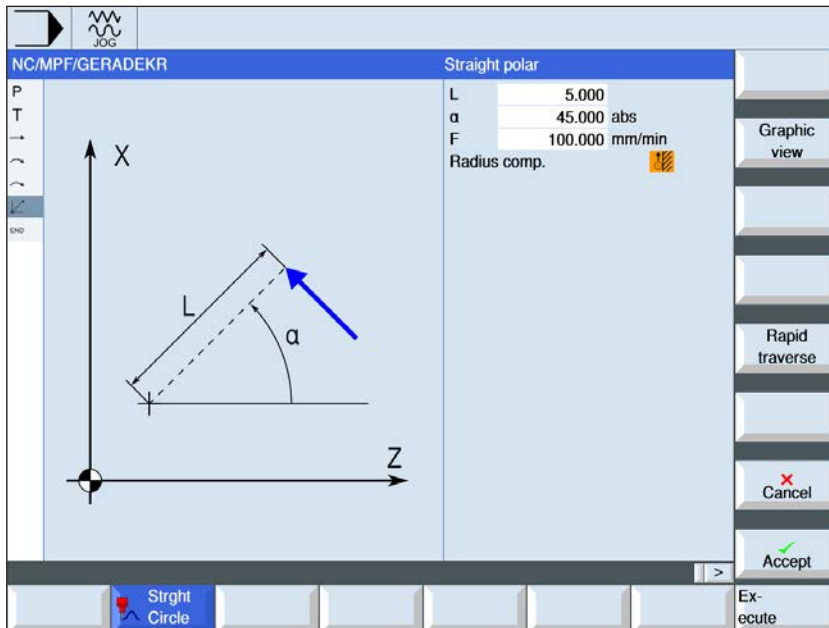

The "Select" button gives you the option to change parameters and/or units. To do this move the cursor to the appropriate field and press button.

Parameter	Description	Unit
L	Distance to pole, end point	mm
α	Polar angle to pole, end point (absolute) or polar angle change to pole, end point (incremental).	
F	Machining feed	mm/min mm/rev mm/tooth
Radius correction	<ul style="list-style-type: none"> left (machining left from the contour) right (machining right from the contour) off no change in the contour 	

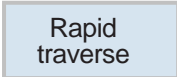

Programming rapid traverse

This softkey programs the feed in rapid traverse.

Cycle description

- 1 The tool moves from the current position on a straight line to the programmed end point in the processing feed or in rapid traverse.
- 2 The first straight line in polar coordinates after the pole data must be programmed with an absolute angle.
- 3 All other straight lines or curves can also be programmed incrementally.



Instructions:
The pole must be defined in an active plane.

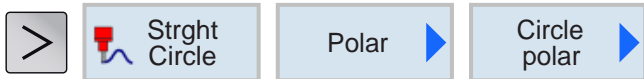

Circle polar

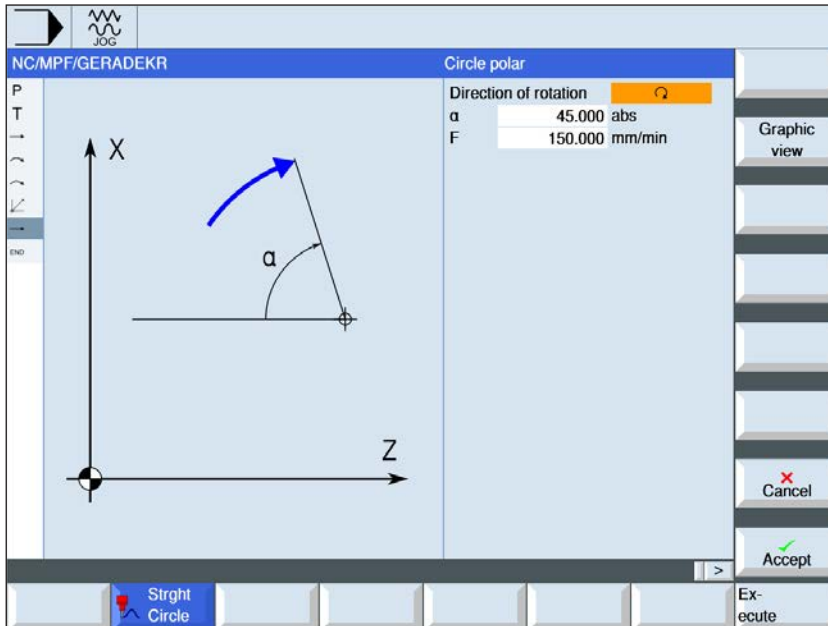

The "Select" button gives you the option to change parameters and/or units. To do this move the cursor to the appropriate field and press button.

Parameter	Description	Unit
Direction of rotation	<ul style="list-style-type: none"> Direction of rotation right Direction of rotation left There will be movement from the circle start point to the circle end point in the programmed direction. This direction can be programmed in the clockwise direction or in the counter-clockwise direction.	
α	Polar angle to pole, end point (absolute) or polar angle change to pole, end point (incremental)	
F	Machining feed	mm/min mm/rev mm/tooth

Instructions:

The pole must be defined in an active plane.



Cycle description

- 1 The tool moves from the current position on a circular path to the programmed end point (angle) in the machining feed. The radius emerges from the current position to the defined pole, i.e. circle start position and circle end position have the same distance to the defined pole.
- 2 The first curve in polar coordinates after the pole data must be programmed with an absolute angle. All other straight lines or curves can also be programmed incrementally.

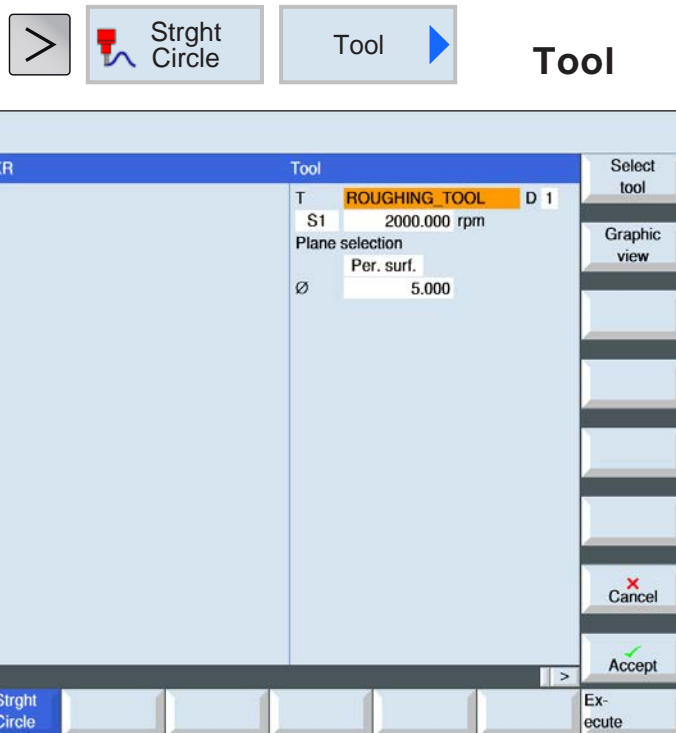

The "Select" button gives you the option to change parameters and/or units. To do this move the cursor to the appropriate field and press button.

Parameter	Description	Unit
T	Tool name	
D	Cutting number	
S1 / V1	Spindle speed or constant cutting speed	rpm m/min
Plane selection	Selection between the following machining surfaces: <ul style="list-style-type: none"> • Side • Front • Rotate 	
∅	Cylinder diameter (for side)	mm
C0	Positioning angle for machining area (for side)	degrees
CP	Positioning angle for machining area (for front)	degrees

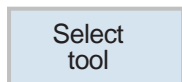

Select tool

- 1 Switch to the tool table with the softkey.
- 2 Create a new tool or select an existing tool (see Chapter F "Tool programming"). The tool will be transferred to the parameter field "T".
- 3 Switch back to the cycle programming with the softkey.

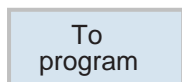

E: G-code programming

Overviews

M-Commands

M 00	Programmed stop
M 01	Optional stop
M 02	End of program
M 2=3	Spindle ON clockwise
M 2=4	Spindle ON counterclockwise
M 2=5	Spindle OFF
M 07	Minimal lubrication ON
M 08	Coolant ON
M 09	Coolant OFF, minimal lubrication OFF
M 17	Sub-routine END
M 20	Quill BACK
M 21	Quill ADVANCE
M 25	OPEN clamping device
M 26	CLOSE clamping device
M 30	End main program
M 71	Purge ON
M 72	Purge OFF
M 90	Manual chuck
M 91	Automatic chuck
M 92	Pressure clamping device

Overview G-commands

Command	Meaning
G0	Rapid traverse motion
G1	Forward motion
G2	Circular interpolation in clockwise direction
G3	Circular interpolation in counter-clockwise direction
G4	Dwell time
G9	Precision stop effective block-by-block
G17	Interpolation plane XY
G18	Interpolation plane XZ
G19	Interpolation plane YZ
G25	Spindle speed limitation
G26	Spindle speed limitation
G33	Thread with constant lead
G331	Thread tapping
G332	Retraction movement during thread tapping
G40	Tool radius compensation off
G41	Tool radius compensation on left
G42	Tool radius correction on right
G53	Blockwise deselection configurable zero point offset
G54-G57	Configurable zero point offsets
G500	Deselection of the configurable NPV
G505-G599	Configurable zero point offsets
G60	Speed decrease, precision stop
G601	Precision stop fine
G602	Precision stop crude
G63	Thread tapping without synchronisation
G64	Path control operation
G70	Inch dimensions
G71	Metric measurement system
G90	Basic dimensions
G91	Incremental dimensions
G94	Feed mm/min or inch/min
G95	Feed in mm/rev or inches/rev
G96	Constant cutting speed on
G961	const. Cutting speed with minute-based feed
G962	const. Cutting speed and maintenance of the current feed type
G97	Constant cutting speed off
G971	const. Speed with minute-based feed
G972	const. Cutting speed and maintenance of the current feed type
G110	pole details, relative to the last programmed tool position
G111	pole details, relative to the current zero point of the workpiece coordinate system
G112	pole details, relative to the last valid pole
G140	Gentle approach and withdrawal
G141	Approaching from left or withdrawing from left
G142	Approaching from right or withdrawing from right
G143	Approach or withdrawal direction dependent on the relative position of the start or end point to tangent direction
G147	Approach in a straight line
G148	Withdraw in a straight line
G247	Approach in a quarter circle
G248	Withdraw in a quarter circle
G340	Approach and withdraw three-dimensionally (base setting)
G341	Approach and withdraw in the plane
G347	Approach with a semi-circle
G348	Withdraw with a semi-circle

Command abbreviations overview

Part 1 valid for turning and milling

Command	Meaning
A	Rotating axis to linear axis X
AC	Absolute position example: X=AC(10)
AMIRROR	Additive mirroring
AND	Logical AND link
ANG	Angle of the straight line
AP	Polar angle of the polar coordinate programming
AR	Opening radius with circular interpolaton
AROT	Additive rotation
ASCALE	Additive scaling
ATRANS	Additive shift
AX	Axis operator
AXIS	Variable type
AXNAME	String operation
AXSTRING	Converts axis name into axis number
B	Rotating axis to linear axis Y
B_AND B_NOT B_OR B_XOR	Logical link operators
BOOL	Variable type
C	Rotating axis to linear axis Z
CASE	Loop construct
CFC	Constant feed at the contour
CFIN	Constant feed at the tool blade
CFINE	Fine shift
CFTCP	Constant feed at the milling cutting tool center point path
CHAR	Variable type
CHF	Insert bevel
CHR	Bevel over corner length
CMIRROR	Mirroring
CR	Circle via radius data
CROT	Rotation
CRPL	Rotation
CSCALE	Scaling
CTRANS	Crude shift
D	Tool cut number
DC	Absolute dimensions, direct positioning
DEF	Define variable
DEFAULT	Loop construct
DELETE	Delete file
DELETE FILE	
DIAMOF	Radius programming
DIAMON	Diameter programming
DISC	Correction to outside corners flexible programming of approach and withdrawal instructions

Command	Meaning
DISCL	Distance of the end point from the processing plane with WAB
DISPLOF	Display in the program window off
DISPLON	Display in the program window on
DISR	Distance of the milling cutting tool from the start point with WAB
DIV	Integer division
ELSE	Loop construct
ENDFOR	Loop construct
ENDIF	Loop construct
ENDLOOP	Loop construct
ENDWHILE	Loop construct
EXECTAB	Trace contour train
EXECUTE	Contour table processing finished
F	Feed
FAD	Infeed advance for soft approach and withdrawal
FB	Block-by-block feed
FOR	Loop construct
FRAME	Variable type
FZ	Feed per tooth
GETTCOR	Read out tool lengths and tool length components
GOTO	Jump instruction only into program end direction then into program start direction
GOTOB	Jump in the direction of the start of the program
GOTOF	Jump in the direction of the end of the program
H	Help function
I	Circle interpolation, detail of the circle center point
IC	Incremental position example: = IC(10)
IS FILE	Check whether a file is present in the NCK application memory
IF	Loop construct
INT	Variable type
INTERSEC	Calculate cutting point of contours
ISAXIS	Is a specific axis is available (query via axis number)
J	Circle interpolation, detail of the circle center point
K	Circle interpolation, detail of the circle center point
KONT	Bypass contour in the start point
LIMS	Speed limitation
LOOP	Loop construct
MCALL	Modal sub-program call
MIRROR	Mirroring on
MSG	Show text on the screen
N	Block number
NORM	Direct approaching of the contour

Command	Meaning
NOT	Negation
OFFN	Offset contour normal
OR	Logical OR link
P	Number of sub-program runs
PROC	Sub-program procedure definition (transfer parameters)
R	R-parameters R[0]-R[299]
REAL	Variable type
REP	Field initialisation
RET	UP-Jump back
RND	Insertion of roundings
RNDM	Modal insertion of roundings
ROT	Rotation on
RP	Polar angle of the polar coordinate programming
RPL	Defining the rotation plane
S	Spindle address
SAVE	Saving register during sub-program call
SBLOF	Single block suppression on
SBLON	Single block suppression off
SCALE	Scale on
SET	Set variables
SETAL	Trigger alarm
SF	Startpoint offset for G3
SPCON	Spindle position control off
SPCOF	Spindle position control on
SPOS	Position position-controlled spindle
SPOSA	Position position-controlled spindle
STRING	Variable type
STRLEN	String operation
SUBSTR	Determine part of a string
SVC	Cutting speed
T	Tool address
TRANS	Move on
TRANSMIT	XY plane transformation
TRACYL	Cylinder jacket curve transformation
TRAFOOF	Transformations off
UNTIL	Loop construct
VAR	Variable definition
WAITS	Wait till the spindle position is reached
WHILE	Loop construct
WRITE	Write text in file system
XOR	Exclusive OR
X	Linear axis parallel to table front edge
Y	Linear axis
Z	Linear axis vertical (milling head)
:	Main block number
/	Skip block recognition

Calculation operators for NC program

Command	Meaning
+, -, *, /, %, ^	Calculation functions
SIN()	Sine function
COS()	Cosine function
TAN()	Tangent function
ASIN()	Arc sine function
ACOS()	Arc cosine function
ATAN()	Arc tangent function (value)
ATAN2(,)	Inverse tangent function (X-section, Y-section)
SQRT()	Square root function
POT()	Power function
EXP()	Exponential function (base e)
LN()	Natural logarithmic function
TRUE	logically true (1)
FALSE	logically false (0)
ABS()	Absolute function
TRUNC()	Integer part function
ROUND()	Rounding function
MOD()	Modulo function

System variables

Command	Meaning
\$A_MYMN	Tool management inactive for all tools
\$A_TOOLMLN	Determine tool magazine place
\$A_YEAR	System time year
\$A_MONTH	System time month
\$A_DAY	System time day
\$A_HOUR	System time hour
\$A_MINUTE	System time minute
\$A_SECOND	System time second
\$A_MSECOND	System time millisecond
\$AA_S	Current speed
\$AA_TYP	Axis type
\$AC_MSNUM	Active master spindle
\$AC_DRF	Handwheel overlaying of an axis
\$AN_NCK_VERSION	NCK version number
\$MA_GEAR_STEP_CHANGE_ENABLE	Configure gear step change
\$MA_NUM_ENCS	Determine axis encoder
\$MA_SPIND_ASSIGN_TO_MACHAX	Axis spindle assignment
\$MC_AXCONF_CHANAX_NAME_TAB	Channel axis name in channel
\$MC_AXCONF_GEOAX_ASSIGN_TAB	Geometry axes (Mill=123, Turn=103)
\$MC_AXCONF_GEOAX_NAME_TAB	Geometry axis name in channel
\$MC_AXCONF_MACHAX_USED	Axis channel assignment
\$MC_CIRCLE_ERROR_CONST	Circle end point monitoring constant
\$MC_DIAMETER_AX_DEF	Geometry axis with plane axis function
\$MC_GCODE_RESET_VALUES	After command for each group after reset
\$MC_MM_SYSTEM_FRAME_MASK	System frames
\$MC_TOOL_CHANGE_MODE	Tool change type: 0=without M6, 1=with M6
\$MC_TOOL_MANAGEMENT_MASK	Activation of the tool management functions
\$MC_TRAFO_TYPE_20	Definition of transformations in the channel
\$MCS_AXIS_USAGE	Meaning of the axis in the channel
\$MCS_AXIS_USAGE_ATTRIB	Attribute of the axes
\$MCS_DISP_COORDINATE_SYSTEM	Geometry axis with plane axis function
\$MCS_ENABLE_QUICK_M_CODES	Enable quick M-codes
\$MCS_FUNCTION_MASK_DRILL	Function mask drill
\$MCS_FUNCTION_MASK_MILL	Function mask mill
\$MCS_FUNCTION_MASK_TECH	Allow block search run in ShopMill/Turn, approach logic via cycle (ShopTurn)
\$MCS_FUNCTION_MASK_TURN	Function mask turn
\$MCS_M_CODE_ALL_COOLANTS_OFF	M-code coolant 1 and 2 off (M9)
\$MCS_M_CODE_COOLANT_1_AND_2_ON	M-code coolant 1 and 2 on
\$MCS_M_CODE_COOLANT_1_ON	M-code coolant 1 (M8)
\$MCS_M_CODE_COOLANT_2_ON	M-code coolant 2 on
\$MCS_TOOL_MCODE_FUNC_OFF	M-code for tool-specific function OFF
\$MCS_TOOL_MCODE_FUNC_ON	M-code for tool-specific function ON
\$MN_ENABLE_CHAN_AX_GAP	Channel axis gaps will be permitted in AXCONF_MACHAX_USED
\$MN_INT_INCR_PER_DEG	Calculating precision for angle positions
\$MN_INT_INCR_PER_MM	Calculating precision for linear positions
\$MN_IPO_PARAM_NAME_TAB	Name of interpolation parameter
\$MN_MM_FRAME_FINE_TRANS	Fine shift with FRAME active
\$MN_MM_NUM_R_PARAM	Number of R-parameters (300)

Command	Meaning
\$MN_MM_TYPE_OF_CUTTING_EDGE	Type of D-number programming
\$MN_SCALING_SYSTEM_IS_METRIC	Metric measurement system is active
\$MN_SCALING_VALUE_INCH	Scaling factor inch/mm
\$MNS_DISP_RES_MM	Show resolution in mm
\$MNS_DISP_RES_INCH	Show resolution in inches
\$ON_TRAFO_TYPE_MASK	Transformations
\$ON_TECHNO_FUNCTION_MASK	Option data
\$P_ACTBFRAME	Determine current overall base frame
\$P_ACTFRAME	Determine current overall frame
\$P_AD	Determine tool parameters of the active tool
\$P_ADT	Determine transformed tool parameters of the active tool
\$P_AXN1	Geometry axis 1
\$P_AXN2	Geometry axis 2
\$P_AXN3	Geometry axis 3
\$P_CYCFRAME	Cycle frame
\$P_DRYRUN	Dry run active
\$P_EP	Current end point in the WKS
\$P_F	Last programmed feed
\$P_F_TYPE	Feed type
\$P_FZ	Last programmed feed FZ
\$P_GG	Active G-code each group
\$P_ISTEST	Simulation interpreter active?
\$P_LINENO	Current line number per program level
\$P_MAG	Magazine description
\$P_MC	Modal cycle active?
\$P_MSNUM	Active master spindle
\$P_OFFN	Programmed contour allowance
\$P_PATH	Program directory per program level
\$P_PFRAME	Determine current programmable frame
\$P_PROG	Program name per program level
\$P_S	Last programmed speed
\$P_S_TYPE	Speed type
\$P_SDIR	Spindle direction of rotation
\$P_SEARCH	Block pre-run active?
\$P_SEARCHL	Block pre-run type
\$P_SIM	Simulation interpreter active?
\$P_SMODE	Spindle operating mode
\$P_STACK	Number of the program on the stack
\$P_TC	Active tool holder
\$P_TOOL	Determine current cutting number
\$P_TOOLL	Determine active tool length
\$P_TOOLNO	Determine current tool number
\$P_TOOLR	Current tool radius
\$P_TRAFO	Active transformation
\$P_TRAFO_PARSET	Active transformation block
\$P_UIFRNUM	Determine active adjustable zero point offset
\$PI	Pi

Command	Meaning
\$SCS_CIRCLE_RAPID_FEED	Rapid traverse feed in mm/min for positioning on a circular path
\$SCS_DRILL_MID_MAX_ECCENT	Maximum center displacement center drilling
\$SCS_DRILL_SPOT_DIST	Spindle behaviour during MCALL drilling
\$SCS_DRILL_TAPPING_SET_GG12	Drilling precision stop behaviour
\$SCS_DRILL_TAPPING_SET_GG21	Drilling acceleration behaviour
\$SCS_DRILL_TAPPING_SET_GG24	Drilling pilot control
\$SCS_DRILL_TAPPING_SET_MC	Spindle behaviour during MCALL drilling
\$SCS_FUNCTION_MASK_DRILL_SET	Function mask drill
\$SCS_FUNCTION_MASK_MILL_SET	Mill function screen
\$SCS_TURN_CONT_TURN_RETRACTION	Contour grooving: Retraction depth before turning
\$SCS_TURN_CONT_VARIABLE_DEPTH	Contour turning: Percentage for variable cut depth
\$SCS_TURN_GROOVE_DWELL_TIME	Freie cut time when grooving on the ground
\$SCS_FUNCTION_MASK_TECH_SET	Technology overview function screen
\$SCS_MILL_CONT_INITIAL_RAD_FIN	Contour pocket milling: Approach radius finishing
\$SCS_SUB_SPINDLE_REL_POS	Free movement position Z for counter-spindle
\$SCS_TURN_CONT_MIN_REST_MAT_AX1	Contour turning: Min. differential dimension residual material machining axis 1
\$SCS_TURN_CONT_MIN_REST_MAT_AX2	Contour turning: Min. differential dimension residual material machining axis 2
\$SCS_TURN_CONT_TRACE_ANGLE	Contour turning: Minimum angle for contour tracing
\$SCS_TURN_CONT_INTER_RETRACTION	Contour turning: Retraction path for feed interruption
\$SCS_TURN_CONT_INTERRUPT_TIME	Contour turning: Feed interruption time (negative values = revolutions)
\$SCS_TURN_CONT_RELEASE_DIST	Contour turning: Retraction amount
\$SCS_TURN_CONT_RELEASE_ANGLE	Contour turning: Retraction angle
\$SCS_TURN_CONT_BLANK_OFFSET	Contour turning: Raw part allowance
\$SCS_TURN_CONT_TRACE_ANGLE	Contour turning: Minimum angle for contour tracing
\$SCS_TURN_CONT_TOOL_BEND_RETR	Contour grooving: Retraction path because of tool bending
\$SCS_TURN_FIN_FEED_PERCENT	Finishing feed for complete machining in %
\$SCS_TURN_ROUGH_I_RELEASE_DIST	Retraction distance machining during internal processing
\$SCS_TURN_ROUGH_O_RELEASE_DIST	Retraction distance machining during external processing

G-commands

G0, G1 straight line interpolation (cartesian)

G0: Move in rapid traverse, e.g. fast positioning
 G1: Move with programmed feed F, e.g. processing the workpiece

Format

G0 X.. Z..
 G1 X.. Z.. F

G0, G1 straight line interpolation (polar)

Format

G0 AP.. RP..
 G1 AP.. RP..

Insert bevel, rounding

Bevels or roundings can be inserted between straight lines and curves in arbitrary combinations.

Format

G.. X.. Z.. CHR=.. Bevel
 G.. X.. Z.. CHF=.. Bevel
 G.. X.. Z.. RND=.. Rounding

Bevel

The bevel will be inserted after the block in which it is programmed.
 The bevel is always on the working level (G18).
 The bevel will be placed symmetrically in the contour corner.
 CHR indicates the length of the bevel.
 CHF indicates the length of the hypotenuse.

Example:
 N30 G1... X.. Z.. CHR=5
 N35 G1... X.. Z..

Rounding

The rounding will be inserted after the block in which it is programmed.
 The rounding is always on the working level (G18).
 The rounding is a curve and will be placed in tangential contact with the contour corner.
 RND indicates the radius of the rounding.

N30 G1... X.. Z.. RND=5
 N35 G1... X.. Z..

Note:
 Before programming, the zero point of the workpiece coordinate system must be set with G111.

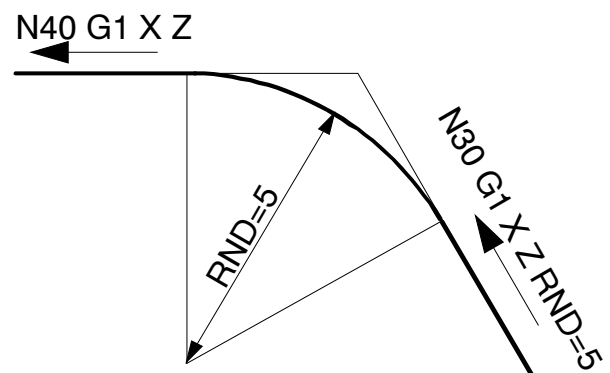
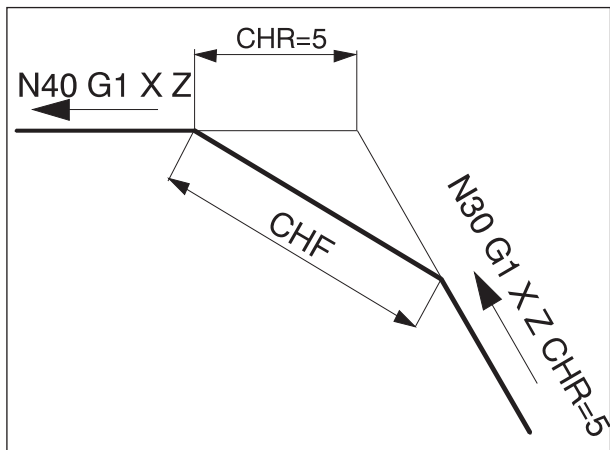

Modal rounding RNDM

At each following contour corner a rounding will be executed, until modal rounding is deselected with RNDM=0.

Example:
 N30 G1 X.. Z.. RNDM=2 Switch on modal filleting. Radius of the rounding: 2 mm

N40 G1 X.. Z..
 N120 RNDM=0 Switch off modal filleting.

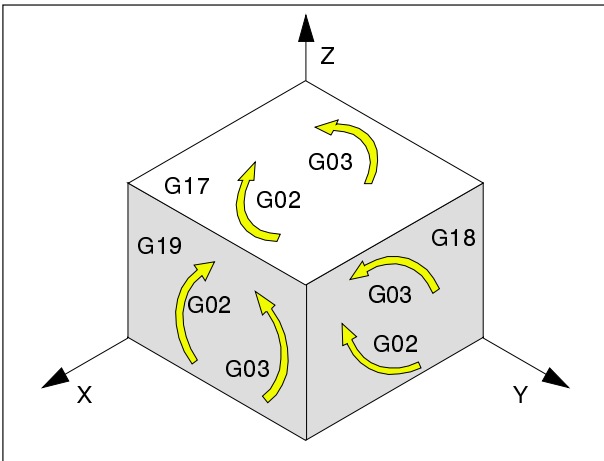

G2, G3, circle interpolation

- G2 clockwise
- G3 counterclockwise

Representation of the circular movement for the various main levels.
 For a circular movement the start and end points are in the same level.

Programming with start point, end point, circle centre

G2/G3 X.. Z.. I.. K..

- X, Z End point E in Cartesian coordinates
- I, K Circle centre M in Cartesian coordinates, relative to start point S

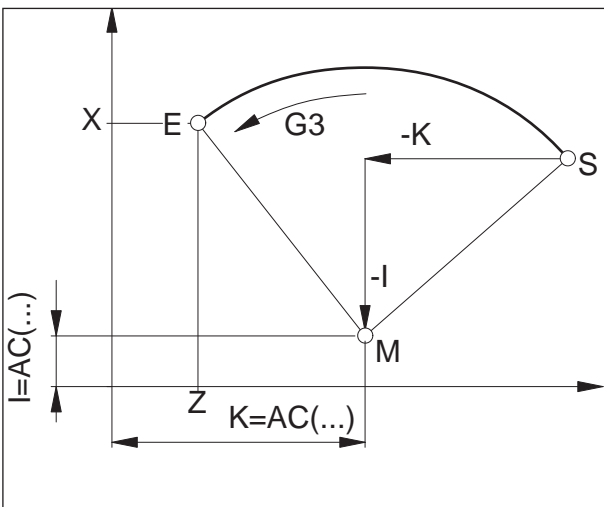

Start point
 The start point is the point where the tool is when the G2/G3 call is made.

End point
 The end point will be programmed with X, Z.

Circle centre
 The circle centre will be programmed incrementally from the start point with I, K or with I=AC(..), K=AC(..) absolutely from the workpiece zero point.

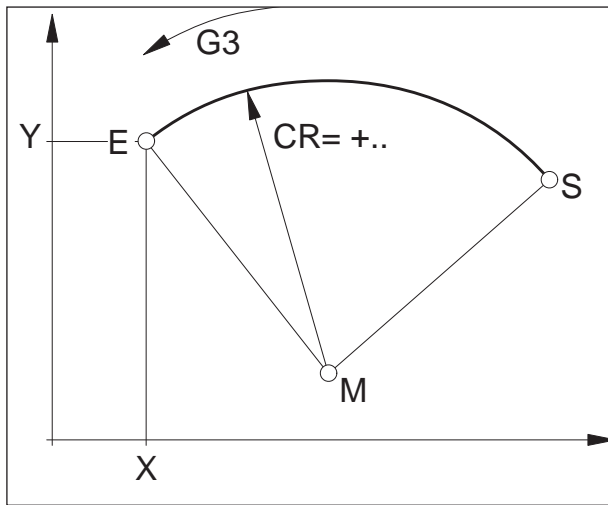

Programming with start point, end point, circle radius

G2/G3 X.. Z.. CR=±..

X, Z End point E in Cartesian coordinates
 CR=± Circle radius

Start point
 The start point is the point where the tool is when the G2/G3 call is made.

End point
 The end point will be programmed with X, Z.

Circle radius
 The circle radius will be indicated with CR. The symbol indicates whether the circle is larger or smaller than 180°.

CR=+ Angle ≤ 180°

CR=- Angle > 180°

Full circles cannot be programmed with CR.

Programming with start point, circle centre or end point, opening angle

G2/G3 X.. Z.. AR=.. or

G2/G3 I.. K.. AR=..

X, Z End point E in Cartesian coordinates
 or

I, K Circle centre M in Cartesian coordinates,
 relative to start point S

AR= Opening angle

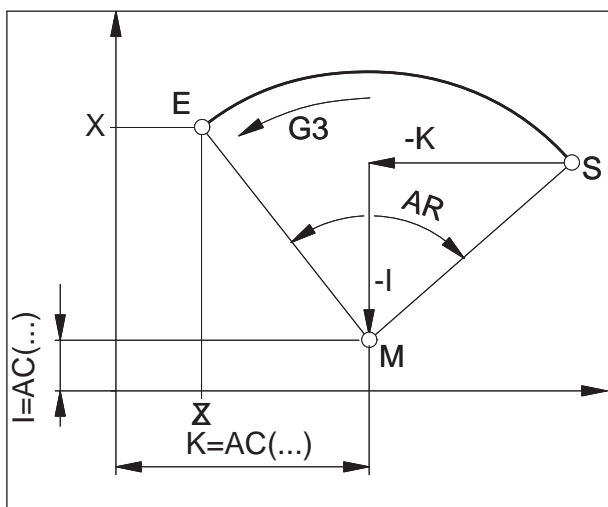

Start point
 The start point is the point where the tool is when the G2/G3 call is made.

End point
 The end point will be programmed with X, Z.

Circle centre
 The circle centre will be programmed incrementally from the start point with I, K or with I=AC(..), K=AC(..) absolutely from the workpiece zero point.

Opening angle
 The opening angle must be < 360°.

Full circles cannot be programmed with AR.

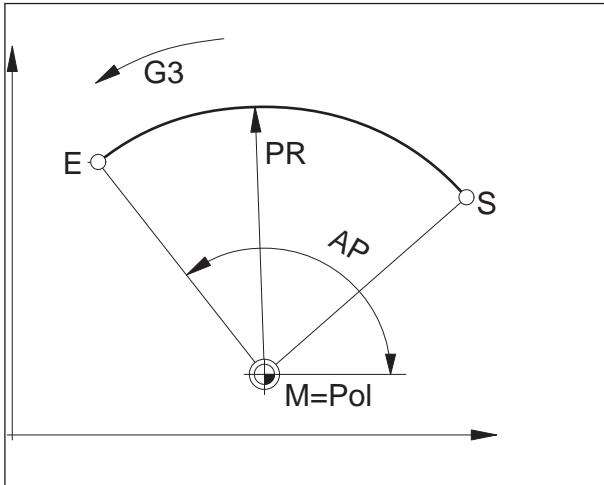

Programming with polar coordinates

G2/G3 AP=.. RP=..

AP= End point E polar angle,
pole is circle centre

RP= Polar radius, concurrently circle radius

The pole of the polar coordinate system must be in the center of the circle (place previously on circle center with G111)

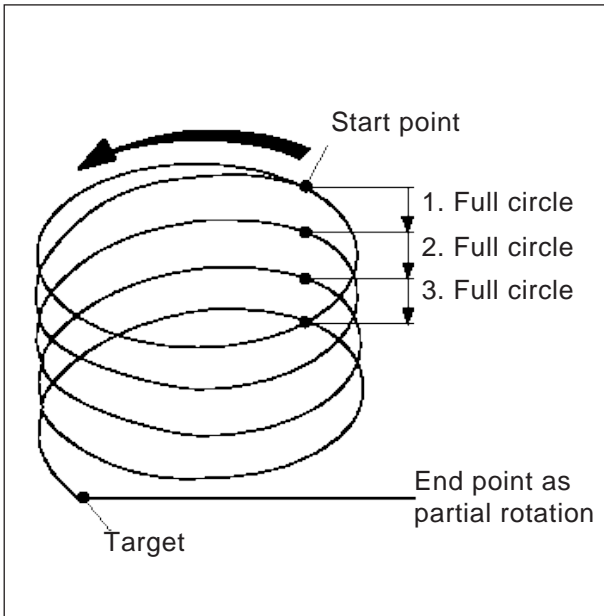

Helical line interpolation

G2/G3 X... Y... Z... I... K... TURN=

G2/G3 X... Y... Z... CR=... TURN=

G2/G3 AR=... I... J... K... TURN=

G2/G3 AR=... X... Y... Z... TURN=

G2/G3 AP... RP=... TURN=

X, Y, Z..... End point E in Cartesian coordinates
I, J, KCircle center in Cartesian

..... coordinates

CR= Circle radius

AR= Opening angle

AP= Polar angle

RP= Polar radius

TURN=Number of additional circle passes in the area from 0 to 999

For detailed explanations of the interpolation parameters see circle interpolation.

G4 Dwell time

Format

N... G4 F... [sec]

N... G4 S... [R]

F Dwell time in seconds

S Dwell time in number of rotations of the main spindle

Clean the tool held in the last reached position - sharp edges - transitions, insertion base, precision stop.

Notes

- The dwell time begins after the feed speed of the preceding block has reached "ZERO".
- Only in the block with G4 are S and F used for time details. A previously programmed feed F and spindle speed S are maintained.

Example

N75 G04 F2.5 (Dwell time = 2.5 sec)

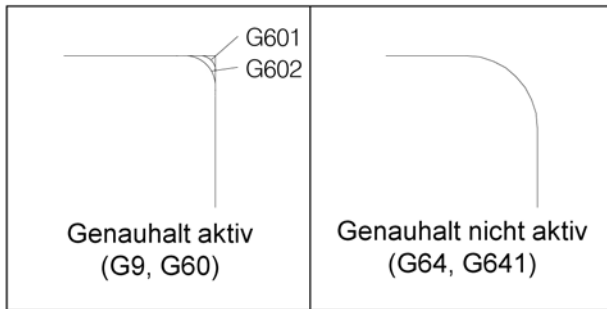

G9, G60, G601, G602, Precision stop

- G9 Precision stop effective block-by-block
- G60 Precision stop effective modally
- G601 Advance when fine position window is reached
- G602 Advance when coarse position window is reached

G601/G602 effective only when G60 or G9 is active.

With the commands G64, G641 - Track control operation, G60 is deselected

G9/G60:

Activation of G601, G602.

G9 is only effective in the block in which it is programmed. G60 is effective until it is deselected with G64 or G641.

G601, G602:

The next block will then only be executed if the block is executed with G9 or G60 and the slides are braked to a stop (short stop time at the end of the block).

In this way the corners will not be rounded and precise transitions achieved.

The target position may lie in a fine (G601) or rough (G602) tolerance field.

G603:

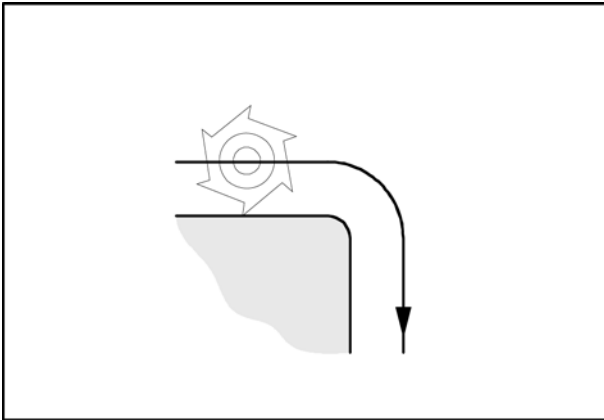

G64 Path control mode

G64 Path control operation

The contour will be created with as constant a path speed as possible.

Shorter processing times and rounded corners are created.

In tangential contour transitions, the tool moves with as constant a path speed as possible; in corners, the speed is reduced correspondingly.

The larger the feed F is, the greater the smoothing down of the corners (contour error).

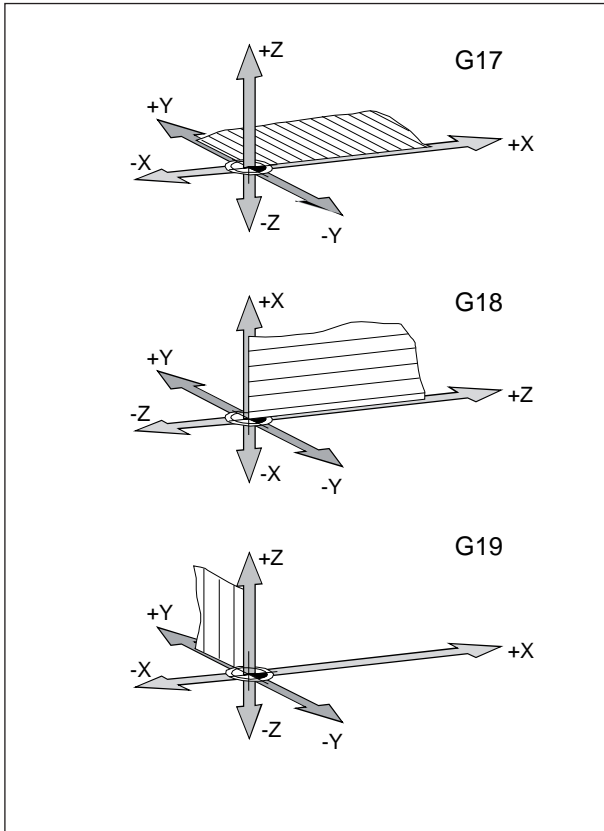

G17, G18, G19 Level selection

Format

N... G17/G18/G19

G17 XY plane: Front machining (TRANSMIT), axial drilling with original Siemens cycles

G18 ZX planes: Contour turning

G19 YZ plane: Side machining (TRACYL), radial drilling with original Siemens cycles

The work level is defined with G17-G19.

- The tool axis sits vertically on the work plane.
- The circle interpolation G2/G3/CIP takes place in the work level
- The polar coordinate interpolation takes place in the work level
- The tool radius correction G41/G42 takes place in the work level
- The infeed movements take place vertically on the work plane, e.g. for drilling cycles.

G25, G26 Spindle speed limitation

Format

N... G25/G26 S...

G25/G26 allow a minimum and maximum speed to be defined for the spindle.

G25 and G26 must be written in a separate program block.

The spindle speed limitation with G25/G26 overwrites the values in the settings data and therefore is preserved after the program ends.

G25	Lower spindle governing
G26	Upper spindle speed limitation
S	Minimum or maximum speed

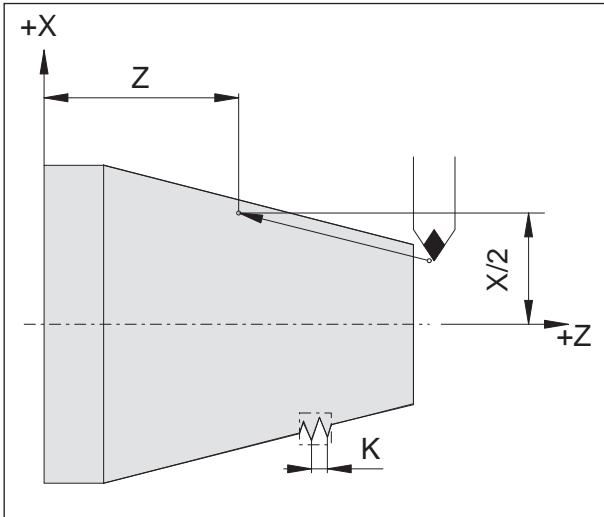

Thread chain example:

```
N011 G33 X... Z... I/K... SF...
N012 G33 X... Z... I/K... SF...
N013 G33 X... Z... I/K... SF...
```

G33 Thread cutting

Format

```
N... G33 X... Z... I/K... SF...
```

- I/K Thread pitch [mm]
- Z Thread depth
- SF Start point offset

Straight, tapered and transverse threads can be cut.

The pitch (I or K) must be indicated in each case, corresponding to the main direction (longitudinal or transverse) of the thread.

Machining processes such as knurling or diamond knurling are also feasible.

Thread chains will be programmed by direct programming consecutively (without positioning movements between threads) by G33 sets.

Notes

- Feed and spindle speed variation are ineffective during G33 (100%).
- A corresponding free groove is to be provided for inward and outward movement.

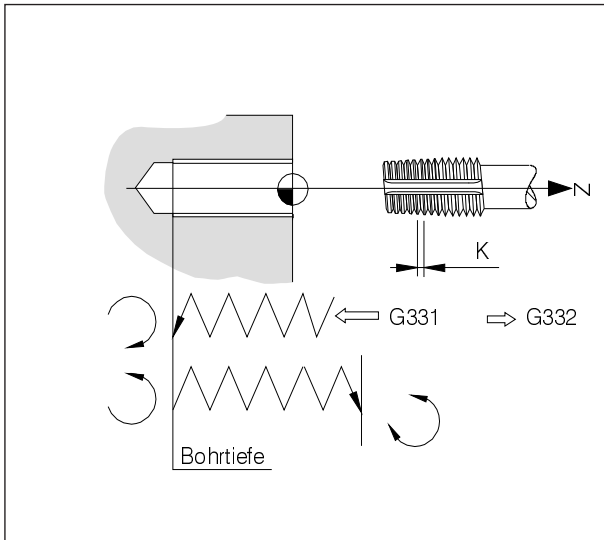

G331/G332 Thread tapping without compensation chuck

(only for machines with position-controlled C-axis)

Format

```
N... G331 X... Z... I/K...
N... G332 X... Z... I/K...
```

- X/Z Drilling depth (end points)
- I/K Thread pitch

Drilling depth, thread pitch
Drilling in Z-direction, thread pitch K

G331 Thread tapping:

The drill hole will be described by drill depth (end point of the thread) and thread pitch.

G332 Retraction movement:

This movement will be described with the same pitch as the G331-movement. The spindle's change of direction takes place automatically.

Instructions:

Before G331 the tool spindle must be positioned at a defined start point with SPOS.



G63 Thread tapping without synchronisation

Format

G63 X.. Z.. F.. S..

Drilling a thread with compensation chuck.

Programmed speed S, programmed feed F and pitch P of the tap must fit together:

$F \text{ [mm/min]} = S \text{ [rev/min]} \times P \text{ [mm/rev]}$ or

$F \text{ [mm/rev]} = P \text{ [mm/rev]}$

The plunge movement of the tap will be programmed with G63.

G63 works block by block. During G63 feed and spindle override are set to 100%.

The retraction movement (with reverse spindle direction) must also be programmed with G63.

Example:

Tap M5 (pitch P = 0.8 mm)

Speed S = 200, so F = 160

```
N10 G1 X0 Z3 S200 F1000 M3  
      (approach start point)
```

```
N20 G63 Z-50 F160  
      (thread tapping, drilling depth 50)
```

```
N30 G63 Z3 M4  
      (retraction movement, reverse spindle  
direction of rotation)
```

Tool radius correction G40-G42

- G40** Tool radius correction OFF
- G41** Tool radius correction LEFT
- G42** Tool radius correction RIGHT

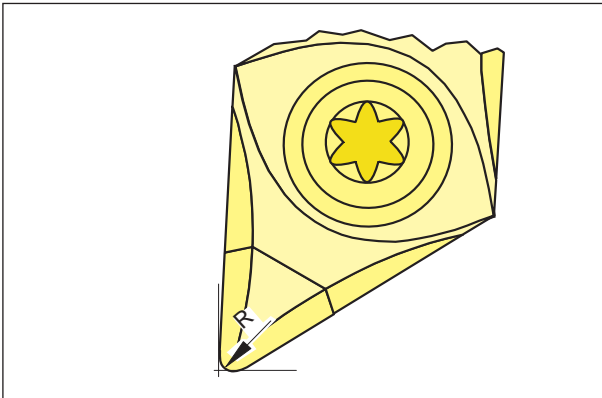

Tip radius and theoretical tooltip.

During the tool measurement, the cutting plate is measured only at two points (tangential to the X- and Z-axes).

The tool correction therefore describes only a theoretical tooltip.

This point is moved to the workpiece on the programmed paths.

Movements in the axial directions (longitudinal or traverse turning) are made with the tangential points on the cutting plate.

There are therefore no dimensional errors at the workpiece.

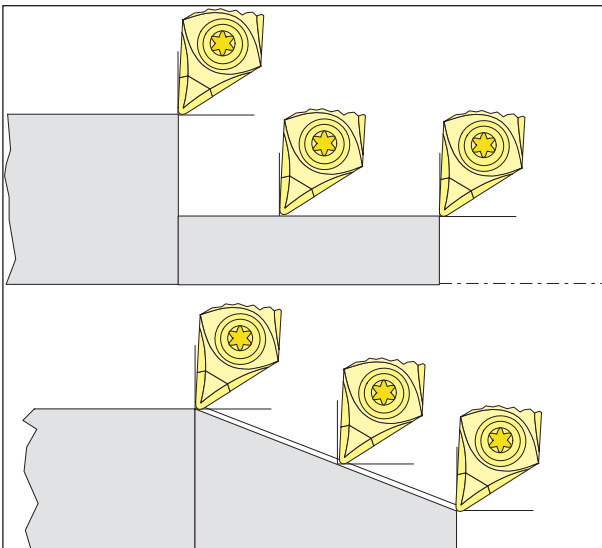

Axis parallel and oblique cutting movements

For concurrent movements in both axial directions (cone, radii) the position of the theoretical cutting point is no longer the same as the actual cutting point on the tool plate.

This generates dimensioning errors at the workpiece.

Maximum contour error without cutting radius for 45° movements:

cutting radius 0.4 mm path separation 0.16 mm
separation in X and Z planes 0.24 mm.

When using cutting radius correction, these dimensioning errors are computed and compensated by the control system automatically.

G40 Deselection tool radius correction

The tool radius correction is deselected by G40. The deselection (withdrawal movement) is only permitted in connection with a straight-line traverse movement (G00, G01).

G40 can be programmed in the same block as G00 or G01 or in the preceding block.

G40 is mostly defined in the retraction to the tool change point.

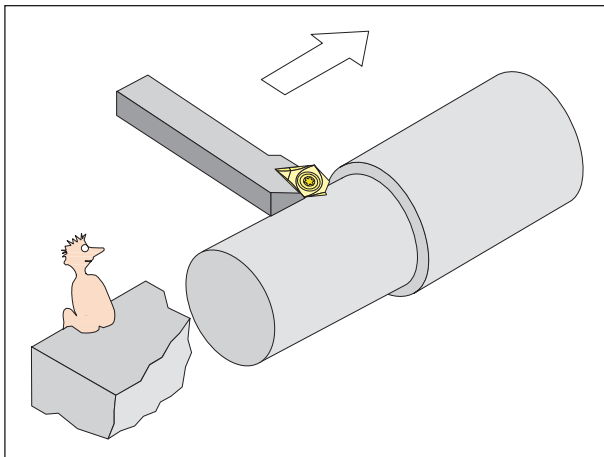

Definition G41 Tool radius correction left

G41 Tool radius correction left

If the tool (seen in the feed direction) is to the **left** of the contour to be processed, G41 must be programmed.

Notes

- Direct change between G41 and G42 is not allowed - prior deselection with G40.
- The statement of the cutting radius R and the cutting position (tool type) is essential.
- Selection (approach movement) in connection with G00 or G01 required.
- Change of tool correction is not possible when tool radius correction selected.

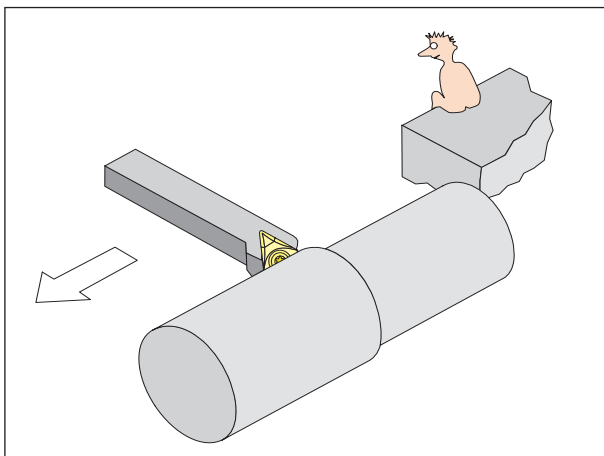

Definition G42 Tool radius correction right

G42 Tool radius correction right

If the tool (seen in the feed direction) is to the **right** of the contour to be processed, G42 must be programmed.

For instructions see G41!

Tool radius correction G40-G42

- G40** Tool radius correction OFF
- G41** Tool radius correction LEFT (up-cut milling)
- G42** Tool radius correction RIGHT (up-cut milling)

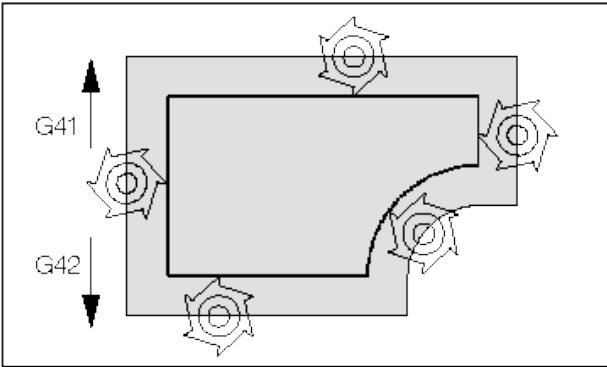

With G41/42 the tool moves on an equidistant path to the programmed contour. The path distance corresponds to the tool radius. To define G41/42 (left/right of the contour) look in the feed direction.

G40 Deselection tool radius correction

The tool radius correction is deselected by G40. The deselection (withdrawal movement) is only permitted in connection with a straight-line traverse movement (G00, G01). G40 can be programmed in the same block as G00 or G01 or in the preceding block. G40 is mostly defined in the retraction to the tool change point.

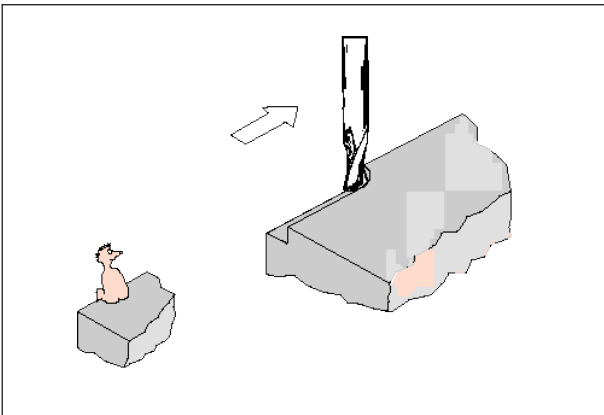

Definition G41 Tool radius correction left

G41 Tool radius correction left

If the tool (seen in the feed direction) is to the **left** of the contour to be processed, G41 must be programmed.

Notes

- Direct change between G41 and G42 is not allowed - prior deselection with G40.
- Selection (approach movement) in connection with G00 or G01 required.
- Change of tool correction is not possible when tool radius correction selected.

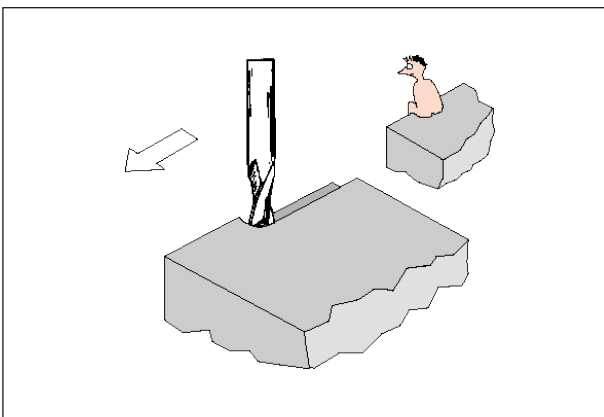

Definition G42 Tool radius correction right

G42 Tool radius correction right

If the tool (seen in the feed direction) is to the **right** of the contour to be processed, G42 must be programmed.

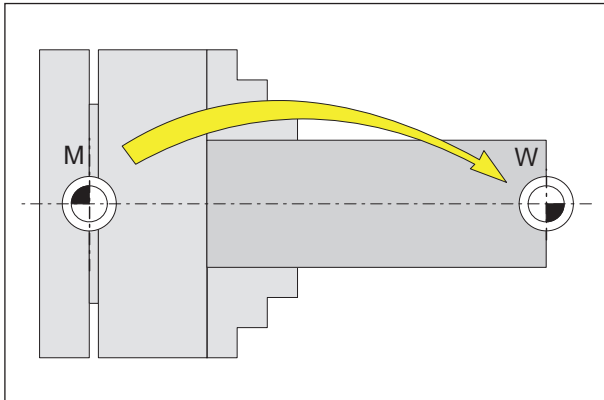

Zero point offset G53-G57, G500-G599, SUPA

- G53 The zero point offsets are suppressed for one block.
- G500 G54 - G599 are deselected.
- G54-57 Call up preset zero point offset.
- G505-599 Call up preset zero point offset.

Zero points are used to show the machine the position of the workpiece.

Typically with G54-G599 the shift to the measurement system takes place on an attachment point (W_1) on the clamping device (saved permanently), the further shift to the workpiece zero point (W_2) takes place with TRANS (variable).

Inch-cased measurements G70, Metric measurements G71

You can enter the following measurements in inches or mm according to G70 / G71:

- Path information X, Z
- Circle parameter I1, K1, I, J, K, CR
- Thread pitch
- Programmable zero point offset TRANS, ATRANS
- Polar radius RP

All other details such as feeds, tool corrections or configurable zero point offsets will be calculated in the measurement unit that is preset in the machine data.



Instructions:

The overall zero point offset effective in a parts program is the sum of the base zero point offset + configurable zero point offsets + Frames.

Coordinates, Zero points

Work plane G17-G19

The tool radius is effective in the work plane, the tool length vertically on the work plane.

Main work plane for turning: G18 (ZX)

Main work plane for milling: G17 (XY), transmit and G19 (YZ), Tracyl.)

G90 absolute measurement input

The measurement details are relative to the current zero point.

The tool moves **TO** a programmed position.

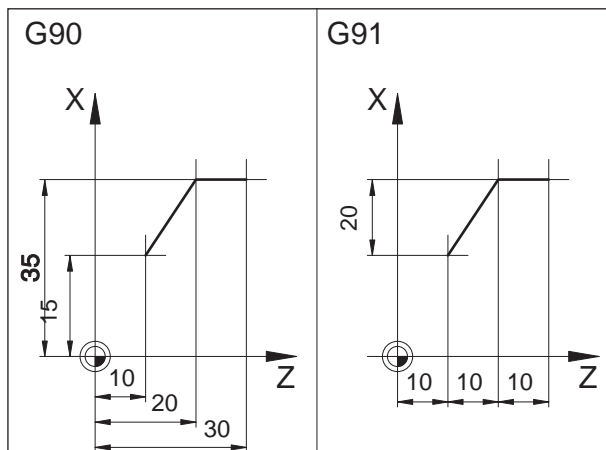

G91 Chain measurement input

The measurement details are relative to the last programmed position of the tool.

The tool traverses **AROUND** a route to the next position.

You can program individual axes independently of G90 / G91, absolutely or incrementally.

Examples:

G90

G0 X40 Z=IC(20)

Here the Y-value is indicated incrementally, although G90 absolute measurement input is active.

G91

G0 X20 Z=AC(10)

Here the Y-value is indicated absolutely, although G91 chain measurement input is active.

Feed programming G94, G95

Overview

- Feed details will not be influenced by G70/71 (inch-mm). The machine data setting applies.
- After each switch between G94/95, F must be re-programmed.
- The feed F applies only for path axes.

Feed F in mm/min G94

Slide movement X, Z:

The address F indicates the feed in mm/min.

Main application for milling.

Feed F in mm/rev G95

Slide movement X, Z:

The address F indicates the feed in mm/rev of the milling spindle.

Circular axis movement C, C3:

Main application for turning.

Block-by-block feed FB

Overview

The "Block-by-block feed" feature specifies a separate feed for an individual block. After this block the previously effective modal feed is active again.

Block-by-block feed FB G94

Feed in mm/min or inch/min or for round axes degrees/min

Block-by-block feed FB G95

Feed in mm/rev or inch/rev or for round axes °/rev

Example:

G0 X0 Y0 G17 F100 G94	Start position
G1 X10	Feed 100 mm/min
X20 FB=80	Feed 80 mm/min
X30	Feed is again 100 mm/min

**Instructions:**

If G95 has still not been programmed, the feed value must be stated in mm/revolution.

Constant cutting speed G96, G97, LIMS

G96 Constant cutting speed and feed type as for G95 ON

G97 Constant cutting speed and feed type as for G95 OFF

G961 Constant cutting speed and feed type as for G94 ON

G962 Linear feed or rotation speed and constant cutting speed

G971 Constant cutting speed and feed type as for G94 OFF

G972 Linear feed or rotation speed and freeze constant cutting speed

S Cutting speed in m/min

LIMS Governing with G96/G961 and G97 both enabled

If G96 is switched on, the spindle speed, in each case dependent on the workpiece diameter, changes automatically such that the cutting speed S in m/min remains constant at the tool cut. This achieves equally dimensioned turning images and this better surface quality.

If a workpiece is machined with a large diametric difference, spindle governing is recommended. This can exclude excessively high speeds with small diameters.

Example

N10 G96 S100 LIMS=2500

Tooth feed FZ

Overview

The cutting speed has a significant influence on the blade temperature and cutting forces. Therefore before a technical calculation of the feed speeds, a cutting speed must be defined.

This connection exists between the teeth feed (FZ), the revolution feed (F) and the number of cutting teeth (N):

$$F = FZ * N$$

F...revolution feed [mm/rev] or[inch/rev]

FZ...tooth feed [mm/tooth] or [inch/tooth]

N...Number of blades [number of teeth]

The number of blades is defined in the tool table in column N.

Example: Milling cutter with 5 teeth (N = 5)

G0 X100 Y50

G1 G95 FZ=0.02 Teeth feed 0.02 mm/tooth

T="Milling cutter 3" D1 M6
Change tool and activate tool
correction data block.

M3 S200 Spindle speed 200 rpm

X20 Milling with: FZ = 0.02 mm/
tooth

Effective revolution feed:

$F = 0.02 \text{ mm/tooth} * 5 \text{ tooth/rev} = 0.1 \text{ mm/rev}$

or: $F = 0.1 \text{ mm/rev} * 200 \text{ rev/min} = 20 \text{ mm/min}$

Instructions:

The tooth feed relates only to the path. Axis-specific programming is not possible.



Polar coordinates G110-G112

With polar coordinate programming the positions are indicated with angle and radius, relative to the pole (origin of the polar coordinate system).

In NC blocks with polar end point data no cartesian coordinates such as interpolation parameters, axis addresses, etc., may be programmed for the selected work plane.

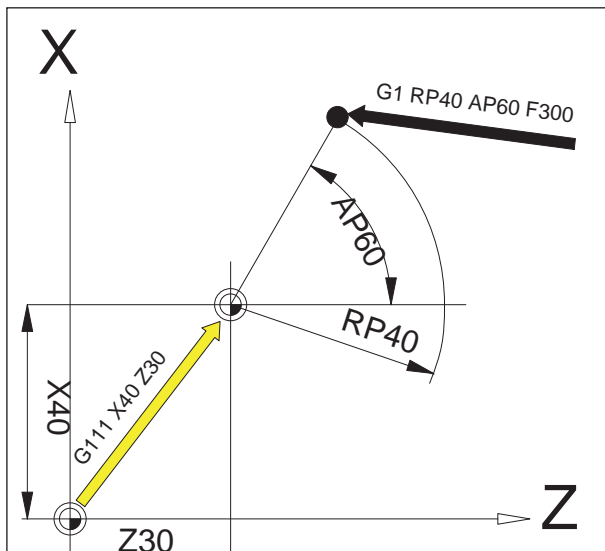

Defining the pole

G110 pole details, relative to the last programmed tool position.

G111 pole details, relative to the current zero point of the workpiece coordinate system.

G112 pole details, relative to the last valid pole.

The pole can be indicated in orthogonal or polar coordinates.

X,Z coordinates of the pole (orthogonal)

RP Polar radius (= distance pole - target point)

AP Polar angle between pole target point and angle reference axis route (first-mentioned pole axis)

Example

```
G111 X30 Z0
```

```
G1 RP=40 AP=60 F300
```

With G111 the pole will be placed on the absolute position 30/40/0.

With G1 the tool will be moved from its previous position to the polar position RP40/AP60.

The angle is relative to the Z-axis (abscissa).

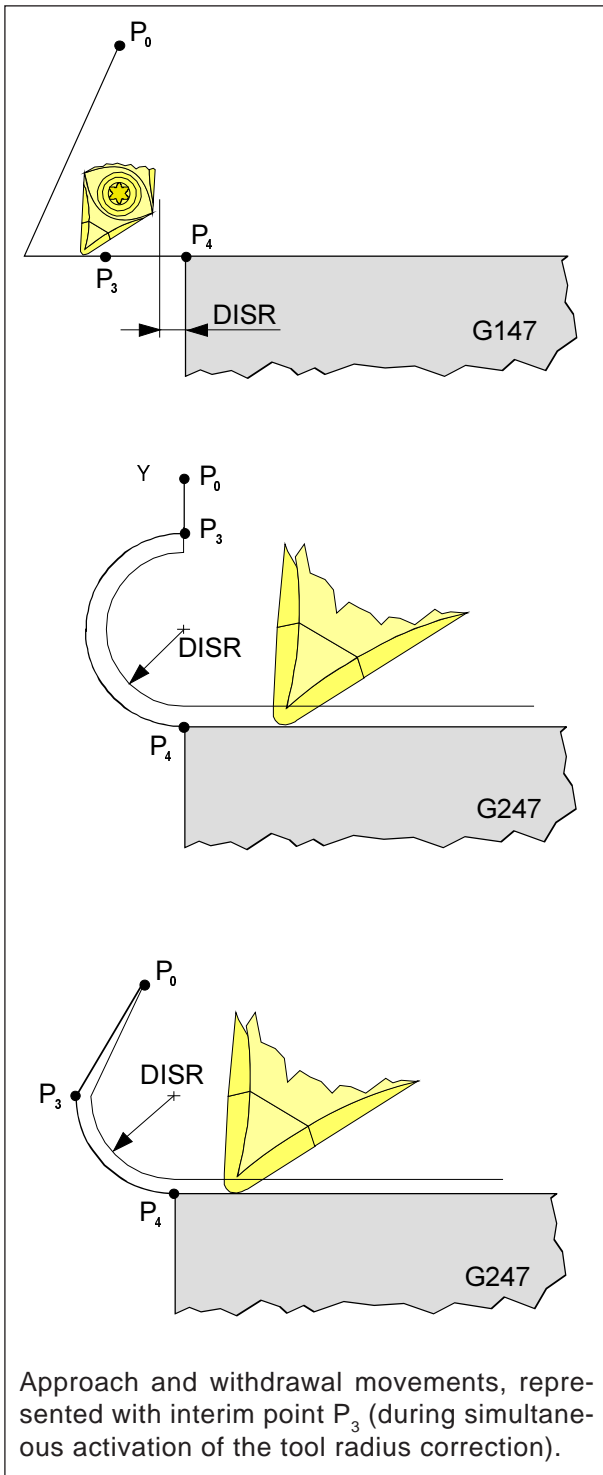

Gentle approach and withdrawal G140 - G341, DISR, DISCL

- G140 Gentle approach and withdrawal
- G141 Approaching from left or withdrawing from left
- G142 Approaching from right or withdrawing from right
- G147 Approach in a straight line
- G148 Withdraw in a straight line
- G247 Approach in a quarter circle
- G248 Withdraw in a quarter circle
- G340 Approach and withdraw three-dimensionally (base setting)
- G341 Approach and withdraw in the plane
- G347 Approach with a semi-circle
- G348 Withdraw with a semi-circle
- G450 Approach and leave contour

- DISR
- Approach and withdrawal with straight lines, distance of the milling cutter tool edge from the start point of the contour
 - Approach and withdraw with circles. Radius of the tool center point path
- DISCL Distance of the end point of the rapid traverse to the processing plane
 DISCL=AC details of the absolute position of the end point of the rapid traverse movement
 DISCL=0
 G340: P₁, P₂, P₃ go together
 G341: P₂, P₃ go together

**Instructions:**

Traverse movements with G0/G1 are to be programmed prior to gentle starting and withdrawal.

Programming G0/G1 in the block is not possible.

This gentle approach and withdrawal function is used to tangentially approach the start point of a contour independently of the position of the point of departure.

The movement to and fro consists of a maximum of 4 part movements:

- Start point of the movement (P_0)
- Interim points (P_1, P_2, P_3)
- End point (P_4)

The points P_0 , P_3 , and P_4 are always defined. The interim points P_1 and P_2 may be inapplicable depending on the processing circumstances.

Infeed movement

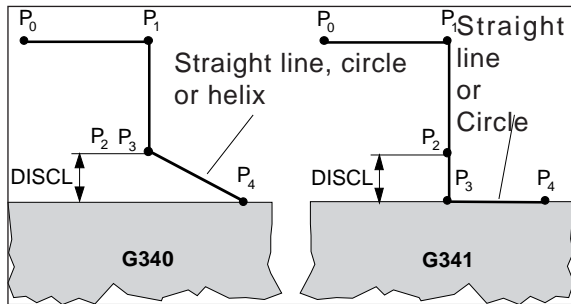

Machining plane

Withdrawal movement dependent on G340/
G341

Selection of the approach or withdrawal direction

Definition of the approach and withdrawal direction using the tool radius correction

when the tool radius is positive:
G41 active - Approach from the left
G42 active - Approach from the right

Division of the movement from start to end point (G340 and G341)

The characteristic approach from P₀ to P₄ is shown in the adjacent image.

In the cases that go into the position of the active planes G17 to G19, any actively rotating FRAME will be taken into account

Collision monitoring NORM, CONT

Approach and leave contours NORM/KONT

NORM: The tool moves in a straight line and sits vertically on the contour point
 If the start/end point are not on the same side of the contour as the first/last contour point, there will be a contour infringement.

CONT: The tool moves around the contour point as programmed under G450.

G450: Move round with circular arc

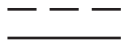

Programmed tool path
 Actual tool path with correction

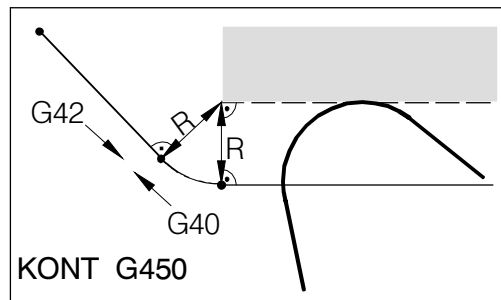
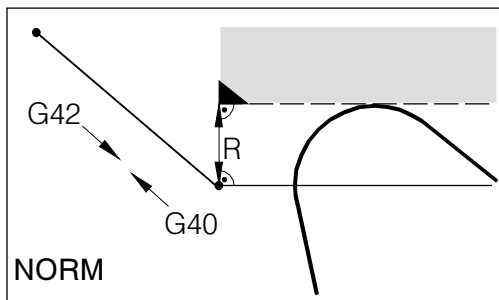
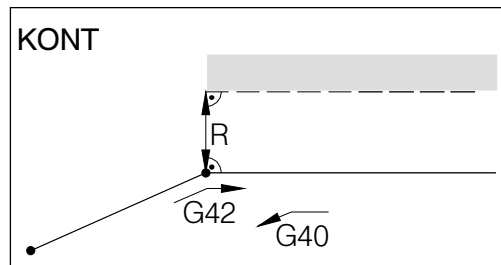
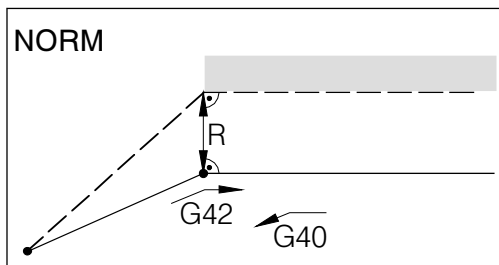

During approach and withdrawal with NORM there may be a contour infringement (black) if the start or end point lie behind the contour.

During approach or withdrawal with KONT the tool moves around the corner with curves (G450).

Cycle overview

The cycle groups with the Sinumerik Operate cycles defined within them are listed here.



Drilling

- Centering
- Drilling
- Abrading
- Long-hole drilling
- Turn out
- Thread
- Positions



Turn

- Machining
- Grooving
- Thread undercut
- Thread
- Grooving



Contour turning

- New contour
- Machining
- Grooving
- Groove turning

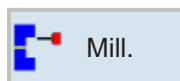

Milling

- Pocket
- Spigot
- Slot
- Thread milling
- Engraving



Contour milling

- New contour
- Path milling
- Pre-drilling
- Pocket
- Spigot

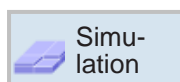

Simulation

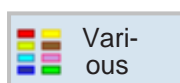

Various

- Raw part
- Transformations
- Sub-routine
- Bar loading interface

Working with cycles

Processes that repeat often, and which include several processing steps, are saved in the control system as cycles. Some special functions are also available as cycles.

Define cycle

The softkey bar shows the different cycle groups.

- Select cycle group
- Select cycle
- Enter all required parameters

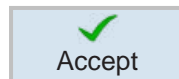
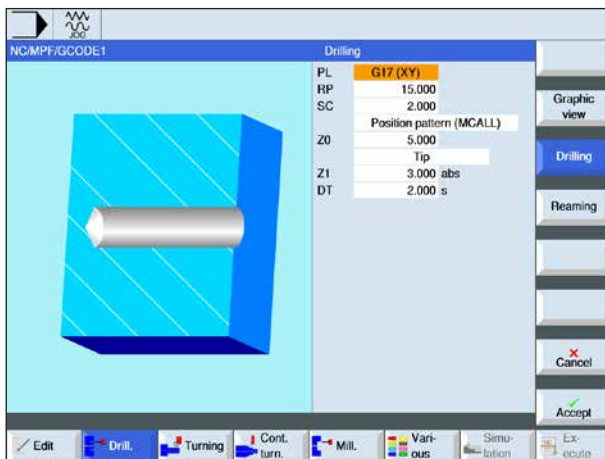

- Terminate input with this softkey.

Geometry and technology data input

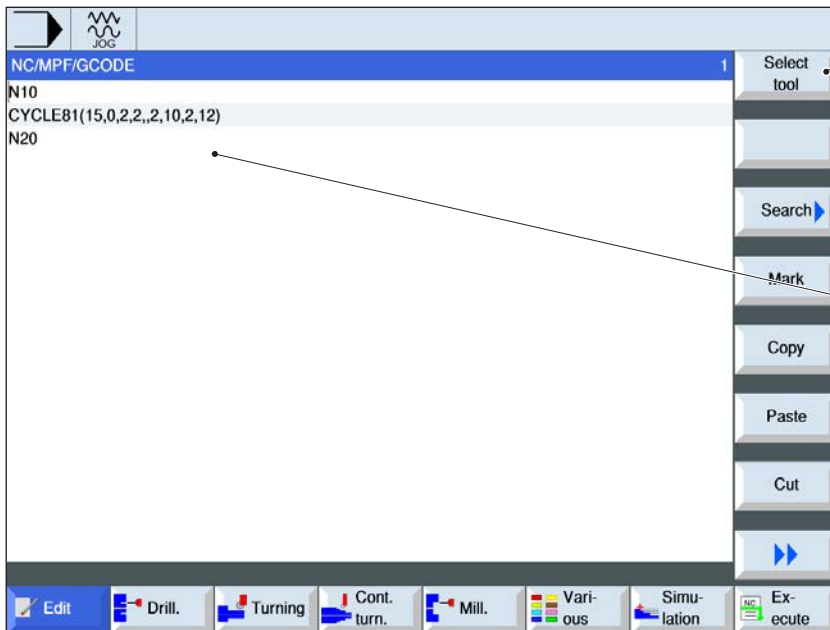

softkey for tool programming. With G-code programs a tool must be selected before invoking cycles.

Program view with command lines

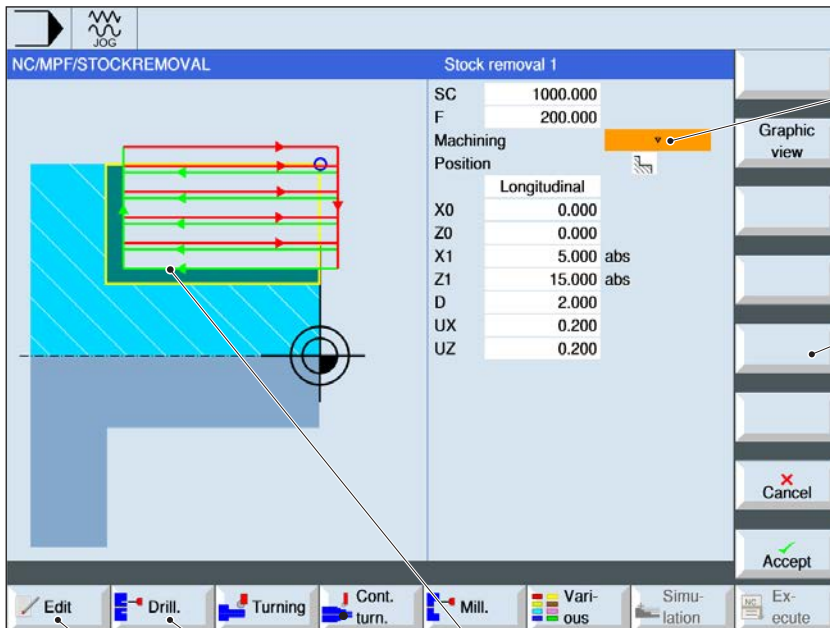

Selection fields: Using the "Select" button parameters and/or units can optionally be changed. To do this move the cursor to the appropriate field and press button.

softkeys for additional functions

Coloured positioning movements:

- Red positioning movement = tool moves in rapid traverse.
- Green positioning movement = tool moves in machining feed.

These softkeys show the cycle groups that are additionally available.

This softkey is used, for example to "Copy", "Paste" and "Delete" cycles.

Invoking cycles

Invoking cycles is done in the following way:

Cycle (parameter 1, parameter 2, etc.)

In the overview screens and in the cycle description you see the parameters required in each case for the individual cycles.

In the call the parameters are registered only with their value (without identifier).

Therefore the sequence of parameters must be maintained, so that values are not misinterpreted. If a parameter is not required, an additional parameter must be set in its place.

**Instructions:**

Cycles can also be called via MCALL. (see "Modal sub-program MCALL")

Default values for cycle parameters

EMConfig is an auxiliary software to WinNC. WinNC settings can be changed with EMConfig.

Open EMConfig and select the configuration point:

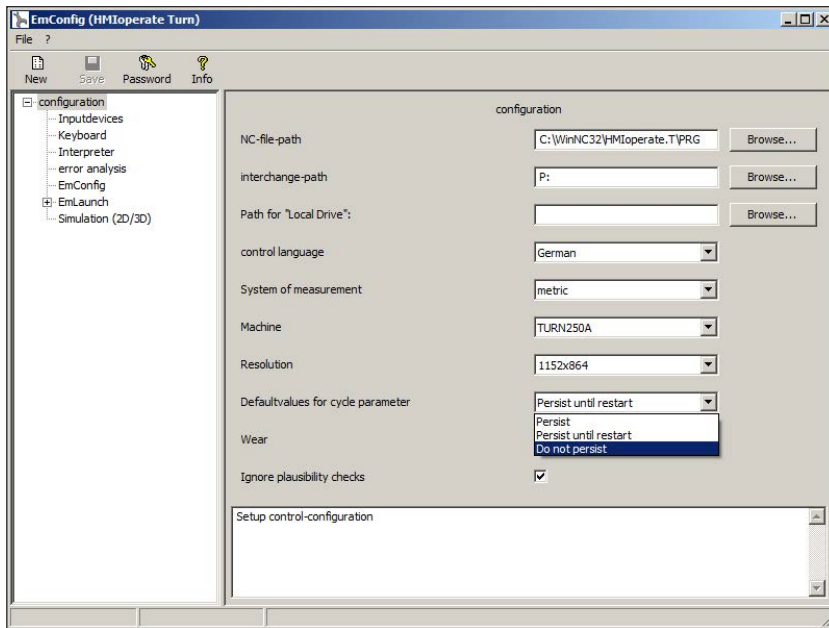

Default values for cycle parameters

The following settings can be reached under the default values heading:

Instructions:

If cycles have already been programmed once, then these input values are saved and next time are proposed as default values. This can be unfavourable in training and can therefore be configured via EMConfig.



- **always maintained**
last entered cycle data remains even after receiving a control system restart
- **replace for restart**
last entered cycle data remains received while the control system is still running
- **never maintained**
Cycle data is reset to the default values immediately after quitting the cycle

Ignore plausibility check for saving

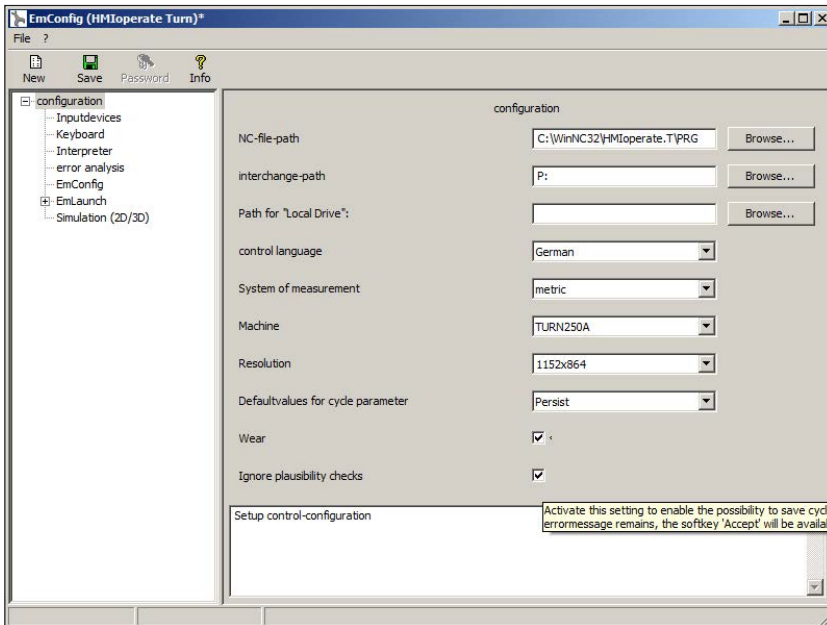

Use this checkbox to activate or deactivate the plausibility check for saving.

Activate this setting to be able to save cycles, despite an error message being present. The corresponding error messages certainly remain in existence, but the "Accept" softkey is available.

Set plausibility check for saving

Set length tool wear

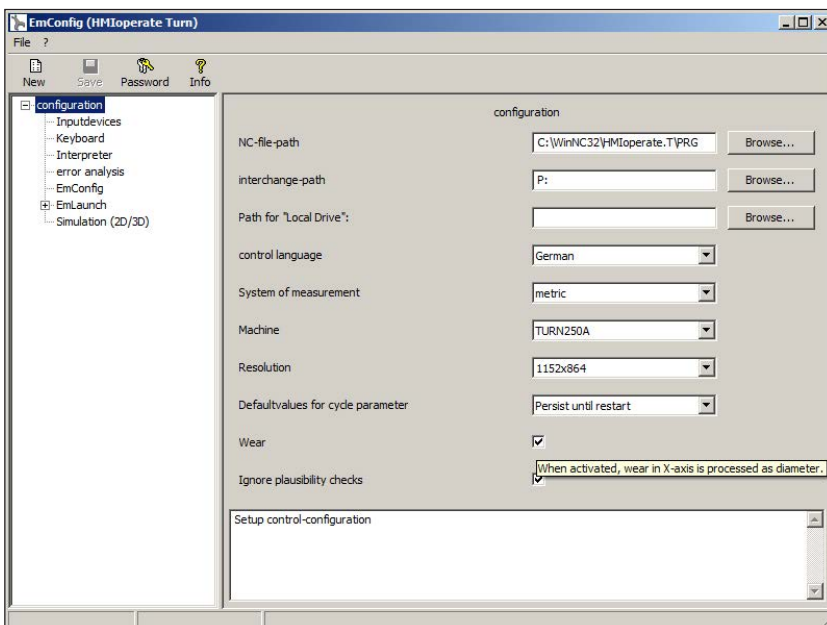

Use this checkbox to state tool wear length for rotating tools as diameter or as length.

Set wear as diameter or length

Instructions:

This setting is only valid for turning tools.



Set system of measurement

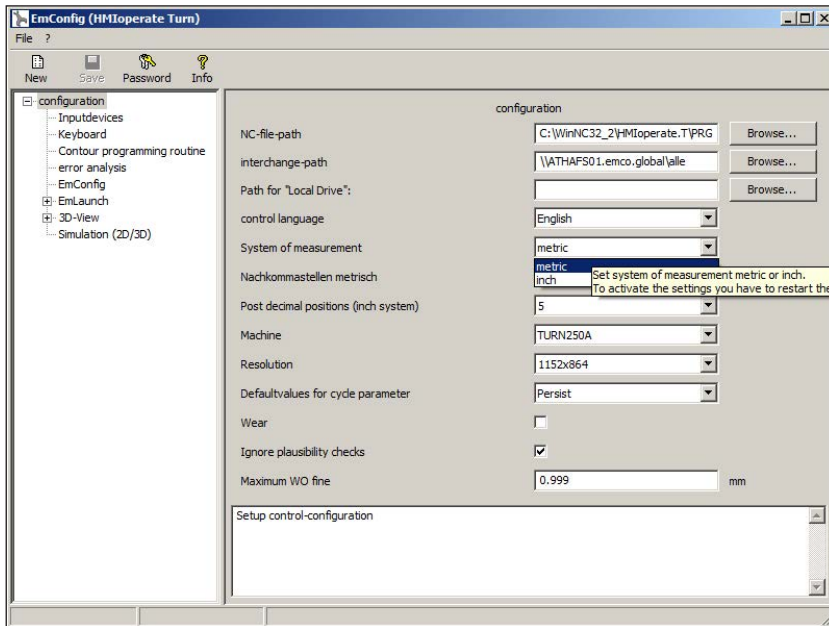

With this checkbox the system of measurement for the control software can be set to metric or inch.

Set the system of measurement to metric or inch

Instructions:

Inch programs can not be used with metric control (and vice versa).

Table of units

inch			
feet ^{°)}	inch	mm	m
1	12	304,5	0,304
inch ^{*)}			
1	0,83	25,4	0,0254

metric			
m	mm	inch	feet
1	1000	39,37008	3,28084
mm	m	inch	feet
1	0,001	0,0393701	0,0032808

*) **feet:** only for constant cutting speed

°) **inch:** standard input



Drilling

- Centering (Cycle81)
- Drilling (CYCLE82)
- Abrading (CYCLE85)
- Drilling deep holes (CYCLE83)
- Turn out (CYCLE86)
- Thread (CYCLE84)
- Position (CYCLE802)



Centering (Cycle81)

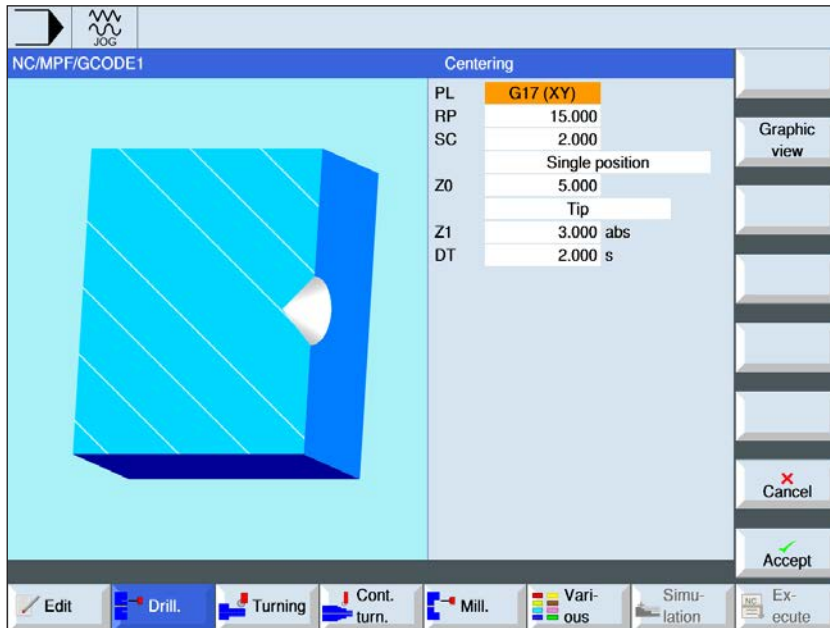

The "Select" button gives you the option to change parameters and/or units. To do this move the cursor to the appropriate field and press button.

Parameter	Description	Unit
PL	Machining plane: <ul style="list-style-type: none"> G17 (XY) G19 (YZ) if nothing is selected, the status of the last setting applies	
RP	Retract plane	mm
SC	Safety distance	mm
Machining position	<ul style="list-style-type: none"> Individual position Drill hole to programmed position. Position template Position with MCALL. 	
Z0	Reference point Z	mm
X0	Reference point X dependent on the selected plane	mm
Centering	<ul style="list-style-type: none"> Diameter (centering relative to the diameter). The center drill angle indicated in the tool list will be taken into account. Tips (centering relative to the depth) The tool plunges to the programmed plunge depth. 	
Ø	The tool plunges until the diameter is reached.	mm
Z1 X1	Drill depth (absolute) or depth relative to Z0 (incremental). Penetration is until Z1 is reached. - (only for tip centering).	mm
DT	<ul style="list-style-type: none"> Dwell time on the ground in seconds Dwell time on the ground in revolutions 	s U

Cycle description

- 1 The control system positions the tool in the spindle axis in rapid traverse (G0) to the safety distance above the reference point.
- 2 The tool centers with the programmed feed (F) till the depth (Z1) or the centering diameter (\emptyset) is reached and dwells there (DT) - if indicated.
- 3 From the centering bottom, the tool moves back to the retraction plane in rapid traverse after the dwell time (DT) ends.

Instructions:

The available axes are dependent on the selected machining plane. This applies for all ISO drilling and milling cycles.



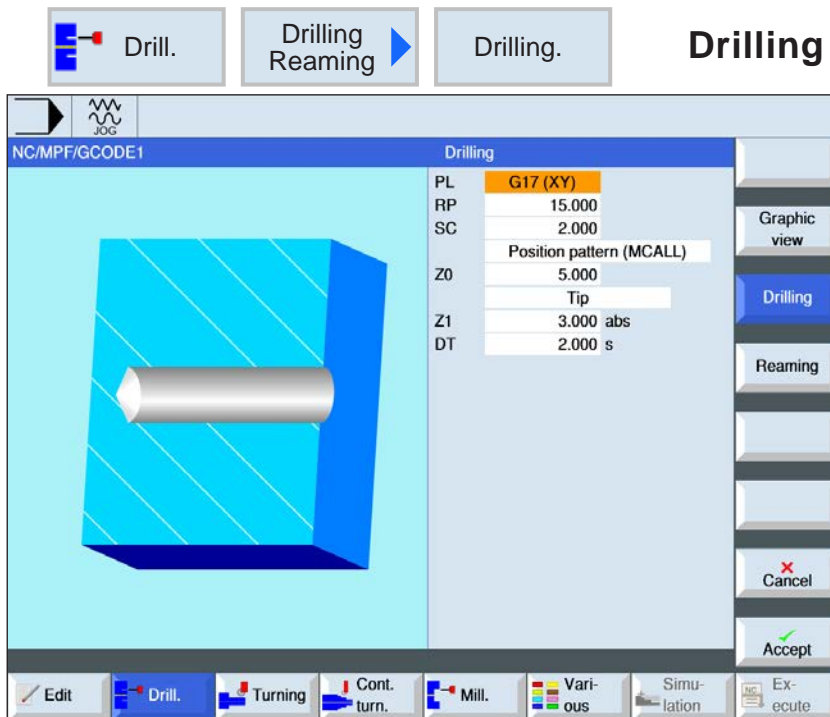

The "Select" button gives you the option to change parameters and/or units. To do this move the cursor to the appropriate field and press button.

Parameter	Description	Unit
PL	Machining plane: <ul style="list-style-type: none"> G17 (XY) G19 (YZ) if nothing is selected, the status of the last setting applies	
RP	Retract plane	mm
SC	Safety distance	mm
M a c h i n i n g p o s i t i o n	<ul style="list-style-type: none"> Individual position Drill hole to programmed position. Position template Position with MCALL. 	
Z0	Reference point Z	mm
X0	Reference point X, dependent on the selected plane	mm
Drill depth	<ul style="list-style-type: none"> Shaft (drilling depth relative to the shaft). The drill plunges until the drill shaft reaches the programmed value Z1. Tip (drill depth relative to the tip) The drill plunges until the drill tip reaches the programmed value Z1. 	
Z1 X1	Drill depth (absolute) or depth relative to Z0 (incremental). The tool plunges until Z1 is reached. (only for tip centering)	mm
DT	<ul style="list-style-type: none"> Dwell time on the ground in seconds Dwell time on the ground in revolutions 	s U

Cycle description

- 1** The control system positions the tool in the spindle axis in rapid traverse (G0) to the safety distance above the reference point.
- 2** The tool centers with the programmed feed (F) till the depth (Z1) is reached and dwells there (DT) - if indicated.
- 3** From the drill bottom the tool moves back to the retraction plane in rapid traverse after expiry of the dwell time (DT).

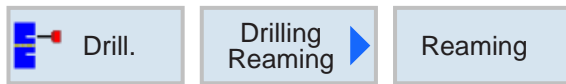

Abrading (CYCLE85)

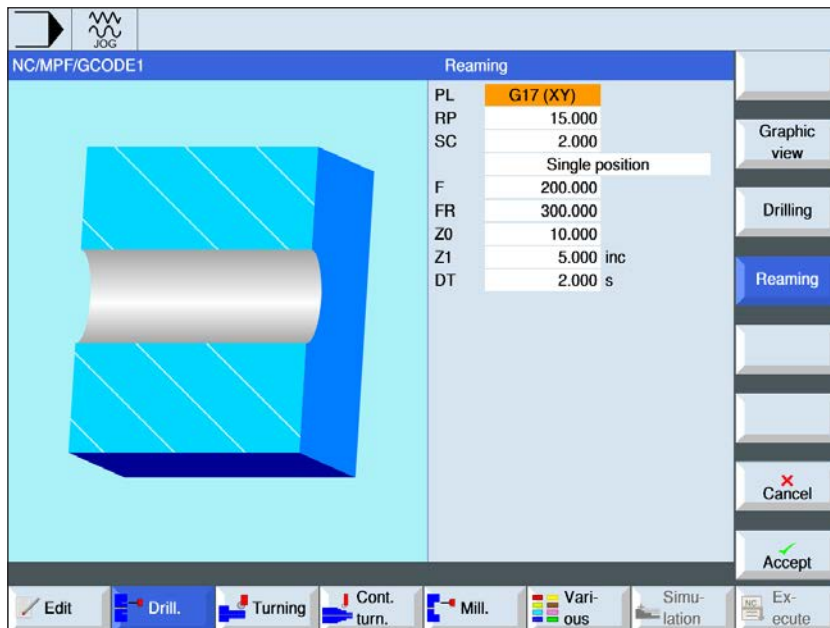

The "Select" button gives you the option to change parameters and/or units. To do this move the cursor to the appropriate field and press button.

Parameter	Description	Unit
PL	Machining plane: <ul style="list-style-type: none"> G17 (XY) G19 (YZ) if nothing is selected, the status of the last setting applies	
RP	Retract plane	mm
SC	Safety distance	mm
Machining position	<ul style="list-style-type: none"> Individual position Drill hole to programmed position. Position template Position with MCALL. 	
F	Feed	mm/min
FR	Feed during retraction	mm/min
Z0	Reference point Z	mm
X0	Reference point X, dependent on the selected plane	mm
Z1 X1	Drill depth (absolute) or depth relative to Z0 (incremental). The tool plunges until Z1 is reached.	mm
DT	<ul style="list-style-type: none"> Dwell time on the ground in seconds Dwell time on the ground in revolutions 	s U

Cycle description

- 1** The control system positions the tool in the spindle axis in rapid traverse (G0) to the safety distance above the reference point.
- 2** The tool reams with the programmed feed (F) till the depth (Z1) is reached and dwells there (DT) - if indicated.
- 3** From the drill bottom the tool moves back to the retraction plane with retraction feed after expiry of the dwell time (DT).

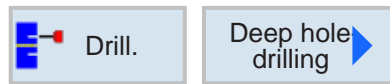

Drilling deep holes (CYCLE83)

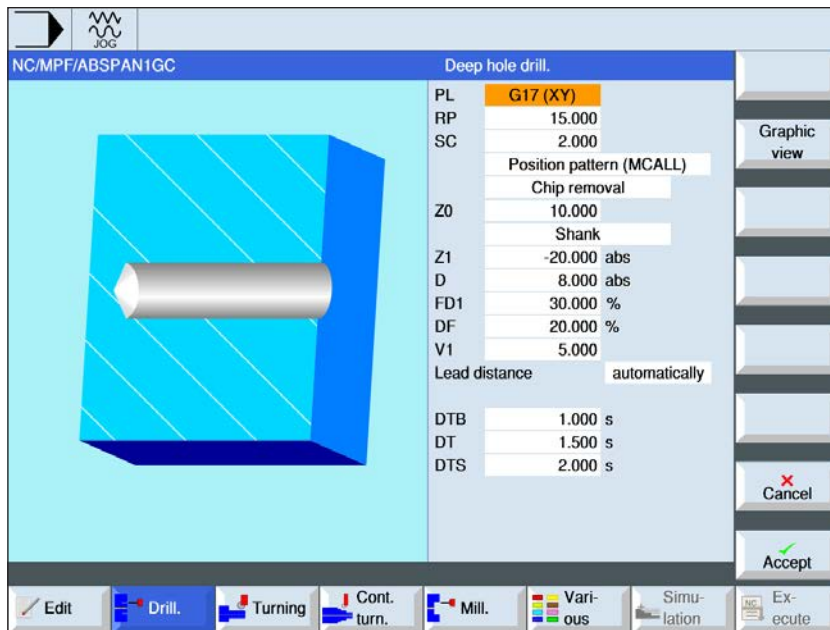

The "Select" button gives you the option to change parameters and/or units. To do this move the cursor to the appropriate field and press button.

Parameter	Description	Unit
PL	Machining plane: <ul style="list-style-type: none"> • G17 (XY) • G19 (YZ) if nothing is selected, the status of the last setting applies	
RP	Retract plane	mm
SC	Safety distance	mm
Machining position	<ul style="list-style-type: none"> • Individual position Drill hole to programmed position. • Position template Position with MCALL. 	
Machining	<ul style="list-style-type: none"> • Chip clearing The drill moves completely out of the workpiece for chip clearing. • Chip crushing The drill withdraws by the retraction amount V2 to break up the chips. 	
Z0	Reference point Z	mm
X0	Reference point X, dependent on the selected plane	mm
Drill depth	<ul style="list-style-type: none"> • Shaft: drilling depth relative to the shaft The drill plunges until the drill shaft reaches the programmed value Z1. The center drill angle indicated in the tool list will be taken into account. • Tips: drill depth relative to the tip The drill plunges until the drill tip reaches the programmed value Z1. Instructions: If no angle for the drill can be given in the tool list, no tip/shaft selection is offered (always tip, 0 field)	

Parameter	Description	Unit
Z1 X1	End drilling depth (absolute) or end drilling depth (incremental) relative to Z0. The tool plunges until Z1 is reached.	mm
D	1. Drill depth (absolute) or drill depth (incremental) relative to Z0.	mm
FD1	Percentage rate for the feed during the first infeed	%
DF	Percentage rate for each additional infeed	mm %
V1	minimum depth infeed (only when DF indicated in %)	
V2	Retract amount after each processing (only when chip crushing selected)	mm
V3	Advanced stop distance (only when chip clearing and advanced stop distance manually selected)	mm
DTB	<ul style="list-style-type: none"> Dwell time at drill depth in seconds Dwell time at drill depth in revolutions 	s U
DT	<ul style="list-style-type: none"> Dwell time on the ground in seconds Dwell time on the ground in revolutions 	s U
DTS	<ul style="list-style-type: none"> Dwell time for chip clearing in seconds Dwell time for chip clearing in revolutions 	s U
Advance distance (only for removing chips)	<ul style="list-style-type: none"> manually Manual entry automatic The advance stop distance will be calculated by the cycle. 	mm

Cycle description**Chip crushing**

- 1 The control system positions the tool in the spindle axis in rapid traverse (G0) to the safety distance above the reference point.
- 2 The tool drills with the programmed spindle speed and the feed speed $F = F * FD1[\%]$ up to the 1st infeed depth.
- 3 The tool reverses by the retraction amount (V2) for chip crushing. Then the tool drills with the programmed feed (F) to the next infeed depth. This will be repeated until the end drilling depth (Z1) is reached.
- 4 From the drill bottom the tool moves back to the retraction plane in rapid traverse (G0) after expiry of the dwell time (DT).

Cycle description**Chip clearing**

- 1 The control system positions the tool in the spindle axis in rapid traverse (G0) to the safety distance above the reference point.
- 2 The tool drills with the programmed spindle speed and the feed speed $F = F * FD1[\%]$ up to the 1st infeed depth.
- 3 The tool moves out of the workpiece to the safety distance in rapid traverse for chip clearing.
- 4 The tool moves in rapid traverse (G0) to the last drilling depth, reduced by the advanced stop distance (V3).
- 5 Then there will be drilling to the next infeed depth.
- 6 Steps 3 to 5 will be repeated until the programmed end drilling depth (Z1) is reached.
- 4 From the drill bottom the tool moves back to the retraction plane in rapid traverse (G0) after expiry of the dwell time (DT).



Turn out (CYCLE86)

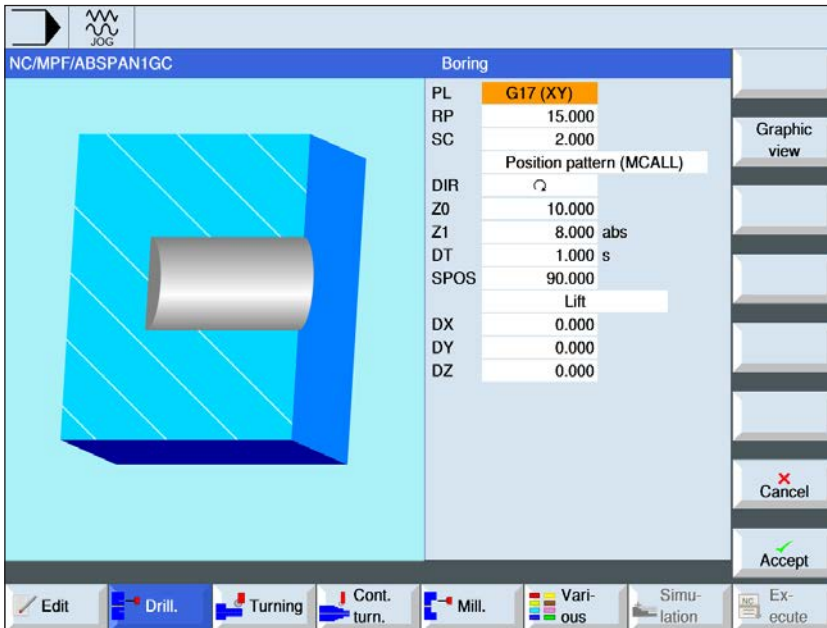

The "Select" button gives you the option to change parameters and/or units. To do this move the cursor to the appropriate field and press button.

Parameter	Description	Unit
PL	Machining plane: <ul style="list-style-type: none"> • G17 (XY) • G19 (YZ) if nothing is selected, the status of the last setting applies	
RP	Retract plane	mm
SC	Safety distance	mm
M a c h i n i n g position	<ul style="list-style-type: none"> • Individual position Drill hole to programmed position. • Position template Position with MCALL. 	
DIR	Direction of rotation <ul style="list-style-type: none"> • Direction of rotation right • Direction of rotation left 	
Z0	Reference point Z	mm
Z1 X1	Drill depth (absolute) or depth relative to Z0 (incremental). The tool plunges until Z1 is reached.	mm
DT	<ul style="list-style-type: none"> • Dwell time on the ground in seconds • Dwell time on the ground in revolutions 	s U

Parameter	Description	Unit
SPOS	Measure spindle stop position manually in degrees and enter.	degrees
Lift mode	<ul style="list-style-type: none"> lift (only for machine with C-axis) The blade moves clear of the drill hole edge and then pulls back to the safety distance from the reference point and then positions on the retraction plane and drill hole center point. do not lift The blade does not move clear, but moves back to the retraction plane in rapid traverse. 	
DX DY DZ	Lift amount in X, Y and Z (incremental, only in lift mode "lift")	mm

Instructions:

The "Turn out" cycle can then be used if the spindle assigned to drilling is capable of moving into position-governed spindle mode.

Clamp the tool in such a way that at the indicated angle SPOS the tool blade is clamped in the +X direction.

**Cycle description**

- 1 The control system positions the tool in the spindle axis in rapid traverse (G0) to the safety distance above the reference point.
- 2 The tool moves with the programmed feed (F) to the drill depth (Z1).
- 3 The tool dwells there (DT) - if indicated.
- 4 Oriented spindle stop at the spindle position programmed under SPOS. To program SPOS the spindle position must be measured manually.
- 5 In lift mode "lift" the tool moves clear of the edge of the drill hole by the lift amount (DX, DY, DZ) in direction -X/ -Y/ +Z.
- 6 The tool moves back to the safety distance in rapid traverse (G0).
- 7 The tool reverses in rapid traverse (G0) to the coordinates of the drill hole center on the retraction plane.



Tapping (Cycle84, 840)

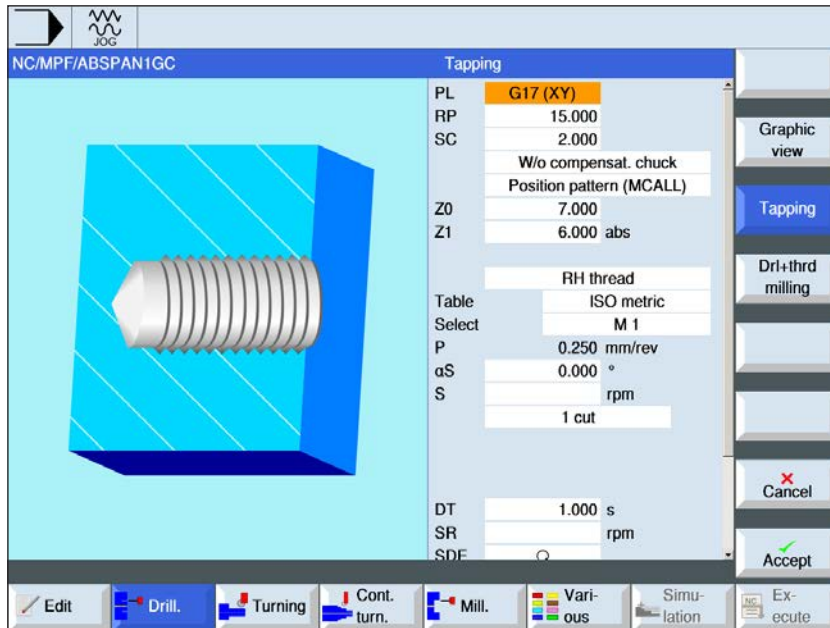

The "Select" button gives you the option to change parameters and/or units. To do this move the cursor to the appropriate field and press button.



Instructions:

This cycle is not available for the Concept TURN 155 and Concept TURN 325 machines.



Parameter	Description	Unit
PL	Machining plane: <ul style="list-style-type: none"> • G17 (XY) • G19 (YZ) if nothing is selected, the status of the last setting applies	
RP	Retract plane	mm
SC	Safety distance	mm
Compensating chuck mode	<ul style="list-style-type: none"> • with compensating chuck: CYCLE840 • without compensating chuck: CYCLE84 	
Machining position	<ul style="list-style-type: none"> • Individual position Drill hole to programmed position. • Position template Position with MCALL. 	
Z0	Reference point Z	mm
Z1 X1	Thread length (incremental) or end point of the thread (absolute). The tool plunges until Z1 is reached.	mm
Processing (with compensating chuck)	<ul style="list-style-type: none"> • with transmitter Thread tapping with spindle transmitter • without transmitter Thread tapping without spindle transmitter; later the selection: - Define "Lead" parameter. 	

Parameter	Description	Unit
Pitch	Only machining without transmitter: <ul style="list-style-type: none"> • User input Lead comes from the input. • active feed Lead comes from the feed. 	
Table	Thread selection table: <ul style="list-style-type: none"> • none • ISO metric • Whitworth BSW • Whitworth BSP • UNC 	
Selection	Selection of the table value e.g.: <ul style="list-style-type: none"> • M1; M5; etc. (ISO metric) • W1/8"; etc. (Whitworth BSW) • G 1 3/4"; etc. (Whitworth BSP) • N8 - 32 UNC; etc. (UNC) (also see thread table with respective pitches)	
P	Display of the thread pitch (only with table selection "none") <ul style="list-style-type: none"> • in MODULE: $MODULE = pitch/\pi$ • in threads per inch: as is typical with pipe threads. With the per inch input, in the first parameter field the whole number before the decimal point is entered and in the second and third field the number after the decimal point is entered as a fraction. • in mm/rev • in inches/rev The thread pitch is dependent on the tool used.	MODULE Threads/" mm/rev inches/rev
αS	Start angle offset (only when thread tapping without compensation chuck)	degrees
S	Spindle speed (only when thread tapping without compensation chuck)	rpm
Processing (without compensating chuck)	<ul style="list-style-type: none"> • 1 cut The thread will be drilled in one cut, without interruption. • Chip crushing The drill pulls back by the retract amount (V2) for chip crushing • Chip clearing The drill moves completely out of the workpiece. 	
D	maximum depth infeed: only if drilling threads without compensating chuck, chip clearing or chip crushing	mm
Retract	Retraction amount: only when "without compensation chuck" and "chip crushing" selected <ul style="list-style-type: none"> • manually With retract amount (V2) after each processing. • automatic Without retract amount (V2) after each processing. The tool will be pulled back by one revolution after each processing. 	

Parameter	Description	Unit
V2	Retract amount after each machining Only when drilling threads without compensating chuck, chip crushing and retraction manually Amount by which the tool will be pulled back during chip crushing	mm
DT	Dwell time at final drill depth in seconds	s
SR	Spindle speed for retraction (only when "without compensating chuck" selected)	rpm
SDE	Direction of rotation after cycle end: <ul style="list-style-type: none"> •  •  •  	
Technology	<ul style="list-style-type: none"> • yes - Precision stop - Spindle • no 	
Precision stop	<ul style="list-style-type: none"> • Behavior as it was before the cycle call-up • G601: Block advance for fine precision stop • G602: Block advance for crude precision stop 	
Spindle	<ul style="list-style-type: none"> • speed-controlled: Spindle with MCAL; speed-controlled mode • position-controlled: Spindle with MCALL; position-controlled mode 	

Thread table

ISO_METRIC		WHITWORTH_BSW		WHITWORTH_BSP		UNC	
M 1	0,250	W 1/16"	60,000	G 1/16"	28,000	N 1 - 64 UNC	64,000
M 1.2	0,250	W 3/32"	48,000	G 1/8"	28,000	N 2 - 56 UNC	56,000
M 1.6	0,350	W 1/8"	40,000	G 1/4"	19,000	N 3 - 48 UNC	48,000
M 2	0,400	W 5/32"	32,000	G 3/8"	19,000	N 4 - 40 UNC	40,000
M 2.5	0,450	W 3/16"	24,000	G 1/2"	14,000	N 5 - 40 UNC	40,000
M 3	0,500	W 7/32"	24,000	G 5/8"	14,000	N 6 - 32 UNC	32,000
M 3.5	0,600	W 1/4"	20,000	G 3/4"	14,000	N 8 - 32 UNC	32,000
M 4	0,700	W 5/16"	18,000	G 7/8"	14,000	N 10 - 24 UNC	24,000
M 4.5	0,750	W 3/8"	16,000	G 1"	11,000	N 12 - 24 UNC	24,000
M 5	0,800	W 7/16"	14,000	G 1 1/8"	11,000	1/4" - 20 UNC	20,000
M 6	1,000	W 1/2"	12,000	G 1 1/4"	11,000	5/16" - 18 UNC	18,000
M 8	1,250	W 9/16"	12,000	G 1 3/8"	11,000	3/8" - 16 UNC	16,000
M 10	1,500	W 5/8"	11,000	G 1 1/2"	11,000	7/16" - 14 UNC	14,000
M 12	1,750	W 3/4"	10,000	G 1 3/4"	11,000	1/2" - 13 UNC	13,000
M 14	2,000	W 7/8"	9,000	G 2"	11,000	9/16" - 12 UNC	12,000
M 16	2,000	W 1"	8,000	G 2 1/4"	11,000	5/8" - 11 UNC	11,000
M 18	2,500	W 1 1/8"	7,000	G 2 1/2"	11,000	3/4" - 10 UNC	10,000
M 20	2,500	W 1 1/4"	7,000	G 2 3/4"	11,000	7/8" - 9 UNC	9,000
M 22	2,500	W 1 3/8"	6,000	G 3"	11,000	1" - 8 UNC	8,000
M 24	3,000	W 1 1/2"	6,000	G 3 1/4"	11,000	1 1/8" - 7 UNC	7,000
M 27	3,000	W 1 5/8"	5,000	G 3 1/2"	11,000	1 1/4" - 7 UNC	7,000
M 30	3,500	W 1 3/4"	5,000	G 3 3/4"	11,000	1 3/8" - 6 UNC	6,000
M 33	3,500	W 1 7/8"	4,500	G 4"	11,000	1 1/2" - 6 UNC	6,000
M 36	4,000	W 2"	4,500	G 5"	11,000	1 3/4" - 5 UNC	5,000
M 39	4,000	W 2 1/4"	4,000	G 6"	11,000	2" - 4 1/2 UNC	4,500
M 42	4,500	W 2 1/2"	4,000			2 1/4" - 4 1/2 UNC	4,500
M 45	4,500	W 2 3/4"	3,500			2 1/2" - 4 UNC	4,000
M 48	5,000	W 3"	3,500			2 3/4" - 4 UNC	4,000
M 52	5,000	W 3 1/4"	3,250			3" - 4 UNC	4,000
M 56	5,500	W 3 1/2"	3,250			3 1/4" - 4 UNC	4,000
M 60	5,500	W 3 3/4"	3,000			3 1/2" - 4 UNC	4,000
M 64	6,000	W 4"	3,000			3 3/4" - 4 UNC	4,000
M 68	6,000					4" - 4 UNC	4,000

Thread table with pitches

Cycle description**Cycle840 with compensating chuck**

- 1 The control system positions the tool in the spindle axis in rapid traverse (G0) to the safety distance above the reference point.
- 2 The tool moves with the programmed speed (S) to the thread depth (Z1). The feed will be calculated inside the cycle from speed (S) and thread lead (P).
- 3 After reaching the thread depth (Z1) the spindle stops and reverses direction.
- 4 The tool dwells at the final drill depth.
- 5 The tool moves back to the safety distance in rapid traverse with G1.
- 6 Again reverse of direction of rotation or spindle stop.
- 7 The tool reverses in rapid traverse (G0) to the coordinates of the drill hole center on the retraction plane.

Cycle description**Cycle84 without compensation chuck 1 cut**

- 1 The control system positions the tool in the spindle axis in rapid traverse (G0) to the safety distance above the reference point.
- 2 The spindle will be synchronized and activated with the programmed speed (S) (dependent on %S).
- 3 With spindle-feed-synchronisation, the tool drills to depth (Z1).
- 4 After reaching the thread depth (Z1) the spindle stops and dwells at the drill depth.
- 5 Once the dwell time has expired, the direction of rotation is reversed.
- 6 The tool moves back to the safety distance with spindle speed for the return (SR) (dependent on %S).
- 7 Spindle stop.
- 8 The tool reverses in rapid traverse (G0) to the coordinates of the drill hole center on the retraction plane.

Instructions:

When single block processing (SBL) is active, the thread tapping will be carried out without block interruption.



Cycle description**Chip clearing**

- 1 The tool drills with the programmed speed (S) (dependent on %S) to the 1st infeed depth (maximum depth infeed D).
- 2 Spindle stop.
- 3 The tool moves out of the workpiece for chip clearing with spindle speed for the return (SR) (dependent on %S).
- 4 The spindle stops and the dwell time is observed.
- 5 The tool drills with spindle depth (S) to the next infeed depth.
- 6 Repeat steps 2 to 5 until the programmed end drilling depth (Z1) is reached.
- 7 The tool moves out of the workpiece with spindle speed for the return (SR) (dependent on %S). The spindle stops and the tool moves back in rapid traverse (G0) to the coordinates of the drill hole center on the retraction plane.

Cycle description**Chip crushing**

- 1 The tool drills with the programmed speed (S) (dependent on %S) to the 1st infeed depth (maximum depth infeed D).
- 2 The spindle stops and the dwell time is observed.
- 3 The tool moves back by the retraction amount (V2) for chip crushing.
- 4 The tool drills with spindle speed (S) to the next infeed depth.
- 5 Repeat steps 2 to 4 until the programmed end drilling depth (Z1) is reached.
- 7 The tool moves out of the workpiece with spindle speed for the return (SR) (dependent on %S). The spindle stops and the tool moves back in rapid traverse (G0) to the coordinates of the drill hole center on the retraction plane.



Thread mill drilling (Cycle78)

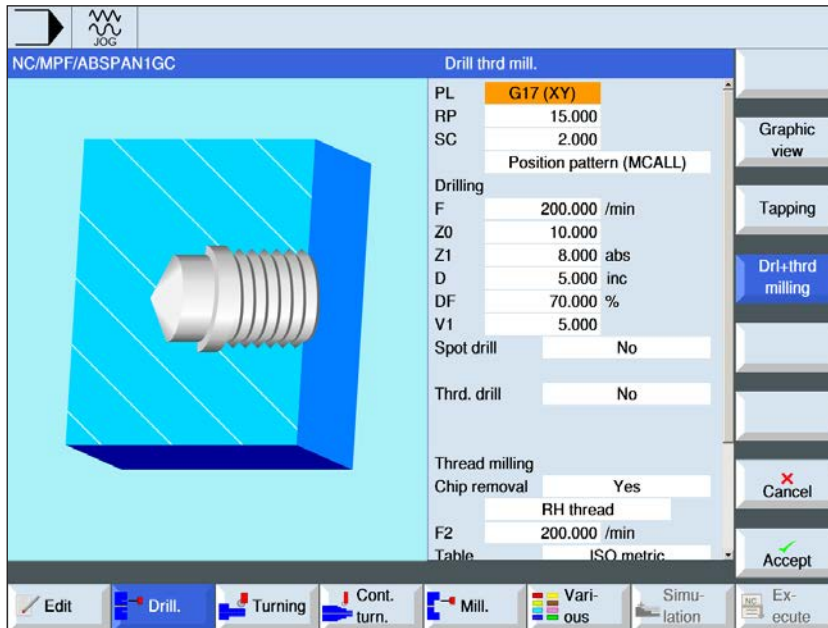

The "Select" button gives you the option to change parameters and/or units. To do this move the cursor to the appropriate field and press button.

Parameter	Description	Unit
PL	Machining plane: <ul style="list-style-type: none"> G17 (XY) G19 (YZ) if nothing is selected, the status of the last setting applies	
RP	Retract plane	mm
SC	Safety distance	mm
Machining position	<ul style="list-style-type: none"> Individual position Drill hole to programmed position. Position template Position with MCALL. 	
F	Drill feed	mm/min mm/rev
Z0	Reference point Z	mm
Z1 X1	Thread length (incremental) or end point of the thread (absolute).	
D	maximum depth infeed <ul style="list-style-type: none"> $D \geq Z1$: eine Zustellung auf Endbohrtiefe. $\dots D < Z1$: Several infeeds with chip clearing. 	
DF	<ul style="list-style-type: none"> Percentage rate for each additional infeed DF=100: Infeed amount remains the same DF<100: Infeed amount will be reduced in the direction final drilling depth Z1. Example: last infeed 5 mm; DF 80% next infeed = 5 x 80% = 4.0 mm next but one infeed = 4.0 x 80% = 3.2 mm etc. amount for each additional infeed 	% mm

Parameter	Description	Unit
V1	minimum infeed (only if DF and percentage for each additional infeed). Parameter V1 is only present if DF<100 was programmed. If the infeed amount is very small, a minimum depth infeed (V1) can be programmed. <ul style="list-style-type: none"> • V1 < Infeed amount (DF): It will be infed by the infeed amount. • V1 > Infeed amount (DF): It will be fed in with the value programmed under V1. 	mm
Boring	Boring with reduced feed <ul style="list-style-type: none"> • yes • no The reduced drill feed results from: Drill feed F1 < 0.15 mm/rev: Bore feed = 30% of F1 Drill feed F1 > 0.15 mm/rev: Anbohrvorschub = 0,1 mm/U	
AZ	Bore depth with reduced drill feed (incremental) (only when boring "yes")	
Through-drilling	Remaining drill depth with drill feed <ul style="list-style-type: none"> • yes • no 	
ZR	Remaining drill depth with through-drilling (only when through-drilling "yes")	mm
FR	Drill feed for remaining drill depth (only when through-drilling "yes")	mm/mm mm/rev
Chip clearing	Chip clearing before thread milling <ul style="list-style-type: none"> • yes • no Move back to the tool surface for chip clearing before thread milling.	
Thread's direction of rotation	<ul style="list-style-type: none"> • Right-hand thread • Left-hand thread 	
F2	Infeed depth thread milling	mm/min mm/tooth
Table	Thread selection table: <ul style="list-style-type: none"> • none • ISO metric • Whitworth BSW • Whitworth BSP • UNC 	
Selection	Selection of the table value e.g.: <ul style="list-style-type: none"> • M1; M5; etc. (ISO metric) • W1/8"; etc. (Whitworth BSW) • G 1 3/4"; etc. (Whitworth BSP) • N8 - 32 UNC; etc. (UNC) (also see thread table with respective pitches)	

Parameter	Description	Unit
P	<p>Display of the thread pitch (only with table selection "none")</p> <ul style="list-style-type: none"> • in MODULE: $\text{MODULE} = \text{pitch}/\pi$ • in threads per inch: As is typical for example with pipe threads. With the per inch input, in the first parameter field the whole number before the decimal point is entered and in the second and third field the number after the decimal point is entered as a fraction. • in mm/rev • in inches/rev <p>The thread pitch is dependent on the tool used.</p>	MODULE Threads/" mm/rev in/rev
Z2	<p>Retraction amount before thread milling (incremental)</p> <p>With Z2 the thread depth is defined in the direction of the tool axis. In this, Z2 is relative to the tool tip.</p>	mm
∅	Nominal diameter	mm
Milling direction	<ul style="list-style-type: none"> • Up-cut: Mill thread in one revolution. • Down-cut: Mill thread in one revolution. • Up-cut - down-cut: Mill thread in 2 revolutions, in which a down-cut rough-milling with a defined extent is carried out followed by a finish-milling with mill feed FS in the up-cut. 	
FS	Finishing feed rate (only when "Up-cut - Down-cut selected")	mm/min mm/tooth

Cycle description

- 1 The control system positions the tool in the spindle axis in rapid traverse (G0) to the safety distance.
- 2 The tool drills with drill feed (F1) to the first drilling depth (maximum infeed depth D). If the final drilling depth (Z1) has still not been reached, the tool moves in rapid traverse (G0) for chip clearing back to the workpiece surface. The tool then positions with rapid traverse (G0) to 1 mm above the previously reached drilling depth, in order to drill further with the next infeed with drill feed (F1). From the 2nd infeed the parameter (percentage rate or amount for each additional infeed DF) will be taken into account.
- 3 When through-drilling if another feed is desired during retraction (FR), the remaining drill depth (ZR) is drilled with this feed.
- 4 The tool moves to the start position for the thread milling.
- 5 The thread milling (up-cut, down-cut or down-cut + up-cut) will be carried out with infeed depth (F2). The inward and outward movement of the milling cutter takes place in a semi-circle with simultaneous infeed in the tool axis.



Positions and position template

When programming machining cycles, there is an option to enter positions or position templates.

A position or position template will only be created after the machining cycle.

Positions or position templates allow several drill or threading operations of the same diameter to be executed together in a cycle. The defined position or a position template will be saved in the cycle list. Various templates are available for this purpose:

- Arbitrary positions
- Positioning on a line, a grid or a frame
- Positioning on full or partial circle



Several position templates can be programmed successively. They will be covered in the programmed sequence.

The previously programmed technologies and the subsequently programmed positions will be automatically chained.

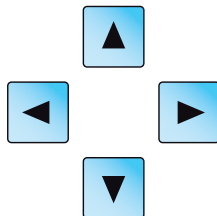

If there are more cycles than are shown in the window, use the cursor keys to scroll through the list.

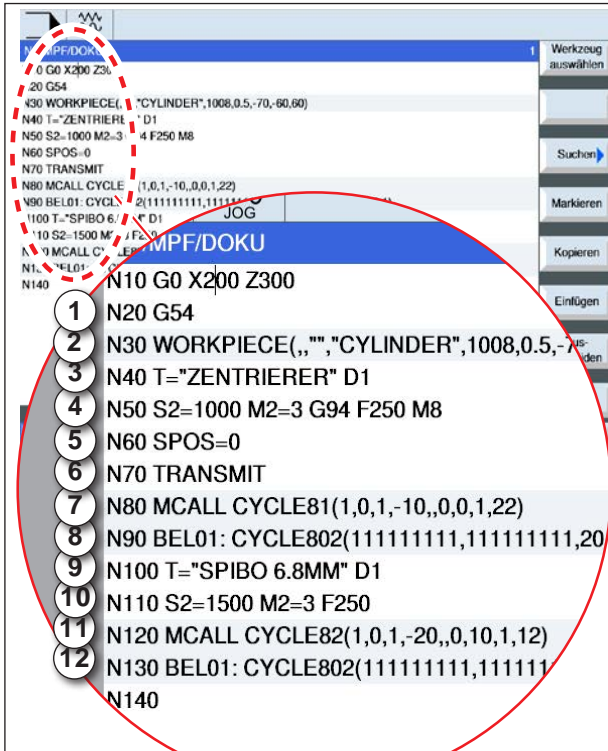

Example for linking processing cycles with position templates

Link representation of position templates with G-code cycles: Only for power tools

A complete processing cycle consists of the processing cycle and the associated position template.

The programming sequence must be observed:

Example:

- 1 Call up preset zero point offset (G54).
- 2 Define unmachined part
- 3 Call up centering tool with blade number 1.
- 4 Define speed (S) and feed (F) and milling cutter's direction of rotation. Activate coolant with M8.
- 5 Set spindle.
- 6 Polar transformation for front surface machining
- 7 There should be an initial centering before the creation of several drill holes.
Program centering cycle (Cycle81) with machining position "Position template MCALL".
- 8 Program position template for centering cycle. (CYCLE802)
- 9 Carry out tool change if needed.
- 10 Define speed (S) and feed (F) and milling cutter's direction of rotation. Activate coolant with M8.
- 11 Program drilling cycle (Cycle82) with processing position "Position template MCALL".
- 12 Program position template for drilling cycle or repeat previous position template.

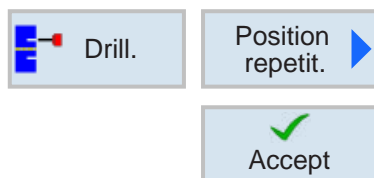

Repeat positions

Press softkey for repeated approach of already programmed positions.

- Repeat jump mark for position indicate and confirm.



Arbitrary positions (CYCLE802)

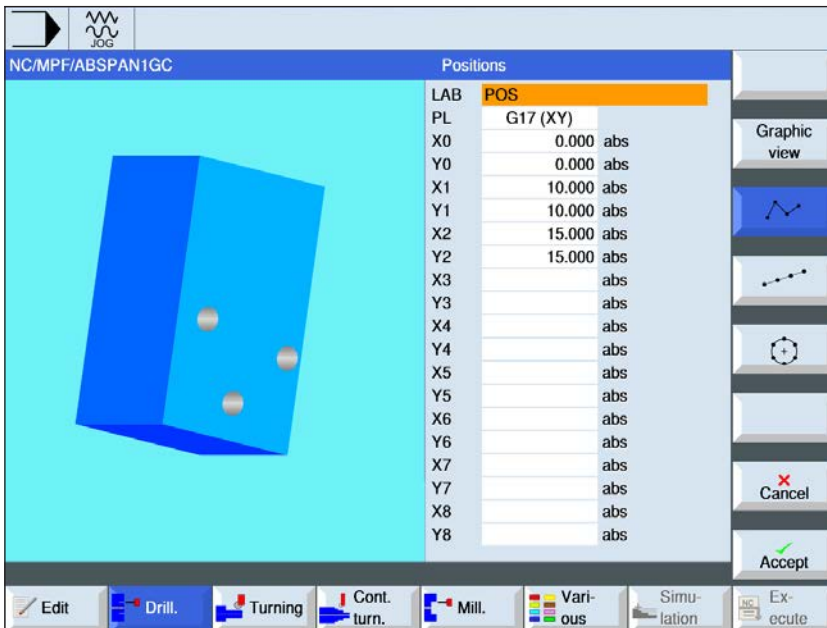

The "Select" button gives you the option to change parameters and/or units. To do this move the cursor to the appropriate field and press button.

Parameter	Description	Unit
LAB	Repeat jump mark for position	
PL	Machining plane: <ul style="list-style-type: none"> • G17 (XY) • G19 (YZ) if nothing is selected, the status of the last setting applies	
X0 Y0	X-coordinate of the 1st position (absolute) Y-coordinate of the 1st position (absolute)	mm
X1...X8 Y1...Y8	X-coordinates of the respective position (absolute or incremental) Y-coordinates of the respective position (absolute or incremental)	mm

Cycle description

- 1 The control system positions the programmed tool. Machining always begins at the reference point.
- 2 Within a position template and when approaching the next position template there will be a movement back to the retract plane and then the new position or the new position template will be approached in rapid traverse (G0).
- 3 With technological follow-up operations (e.g. Centering - Drilling - Thread tapping), after calling up the next tool (e.g. drill), the particular drilling cycle is to be programmed and the calling up of the position template executed immediately afterwards.

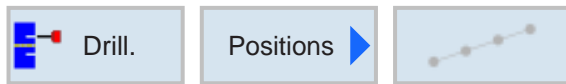

Position template line (HOLES1), grid or frame (CYCLE801)

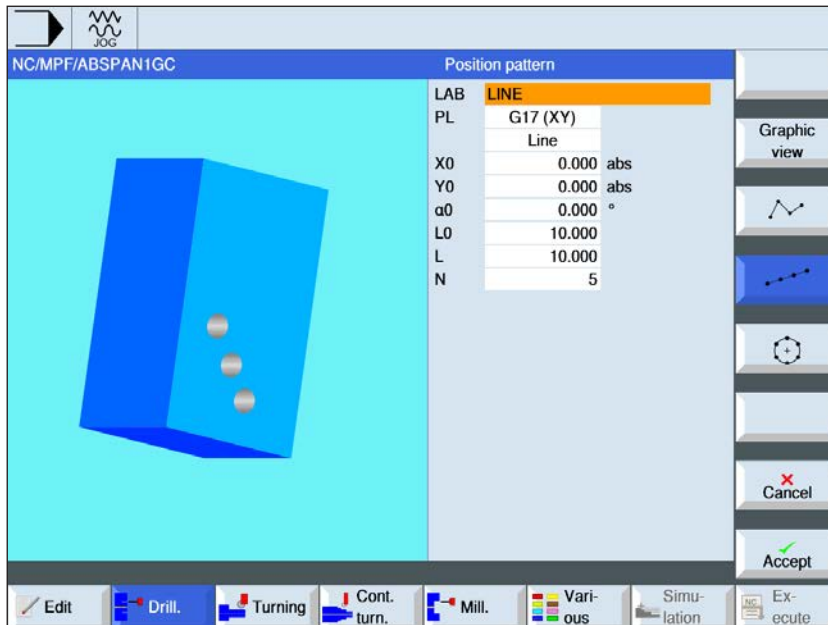

The "Select" button gives you the option to change parameters and/or units. To do this move the cursor to the appropriate field and press button.

Parameter	Description	Unit
LAB	Repeat jump mark for position	
PL	Machining plane: <ul style="list-style-type: none"> • G17 (XY) • G19 (YZ) if nothing is selected, the status of the last setting applies	
Position template	<ul style="list-style-type: none"> • Line (HOLES1) • Grid (CYCLE801) • Frame (CYCLE801) 	
X0, Z0	Coordinate of the reference point (absolute).	mm
α_0	Angle of the line, relative to the X-axis Positive angle: Line will be rotated counter-clockwise. Negative angle: Line will be rotated clockwise.	degrees
L0	Distance from 1st position to reference point (only when "Position template line" selected)	mm
L	Distance between the positions - (only when "Position template line" selected)	mm
N	Number of positions - (only when "Position template line" selected)	
L1, L2	Spacing of lines and gaps - (only when "Position template grid or frame" selected)	mm
N1, N2	Spacing of lines and gaps - (only when "Position template grid or frame" selected)	

Cycle description

- 1 The processing always starts the nearest corner of the frame or grid or at the end of the row. The position template frame will be processed further in the counter-clockwise direction.



Position template circle (HOLES2)

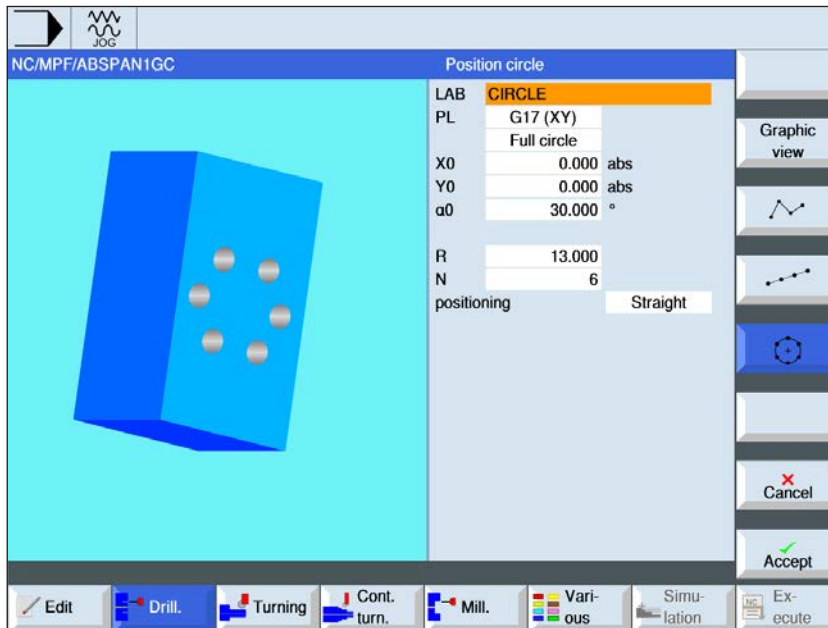

The "Select" button gives you the option to change parameters and/or units. To do this move the cursor to the appropriate field and press button.

Parameter	Description	Unit
LAB	Repeat jump mark for position	
PL	Machining plane: <ul style="list-style-type: none"> • G17 (XY) • G19 (YZ) if nothing is selected, the status of the last setting applies	
Circle template	<ul style="list-style-type: none"> • Full circle • Partial circle 	
X0 Y0	Coordinate of the reference point (absolute).	mm
α0	Start angle for first position Positive angle: Full circle will be rotated counter-clockwise. Negative angle: Full circle will be rotated clockwise.	degrees
α1	Angle of advance only if circle segment After the first drill hole is finished, all further positions will be positioned onward by this angle. Positive angle: further positions will be rotated counter-clockwise. Negative angle: further positions will be rotated clockwise.	degrees

Parameter	Description	Unit
R	Radius	mm
N	Number of positions - (only when "Circle template partial circle" selected).	
position	Positioning movement between the positions <ul style="list-style-type: none">• Straight line Next position will be approached in rapid traverse (G0) in a straight line.• Circle Next position will be approached on a circular path with the programmed feed (FP).	

Cycle description

- 1 The circle template must be machined further in the clockwise or counterclockwise sense.



Turn

- Machining (CYCLE951)
- Grooving (CYCLE930)
- Free groove (CYCLE940)
- Free groove thread (CYCLE940)
- Cutoff (CYCLE92)



Machining 1 (CYCLE951)

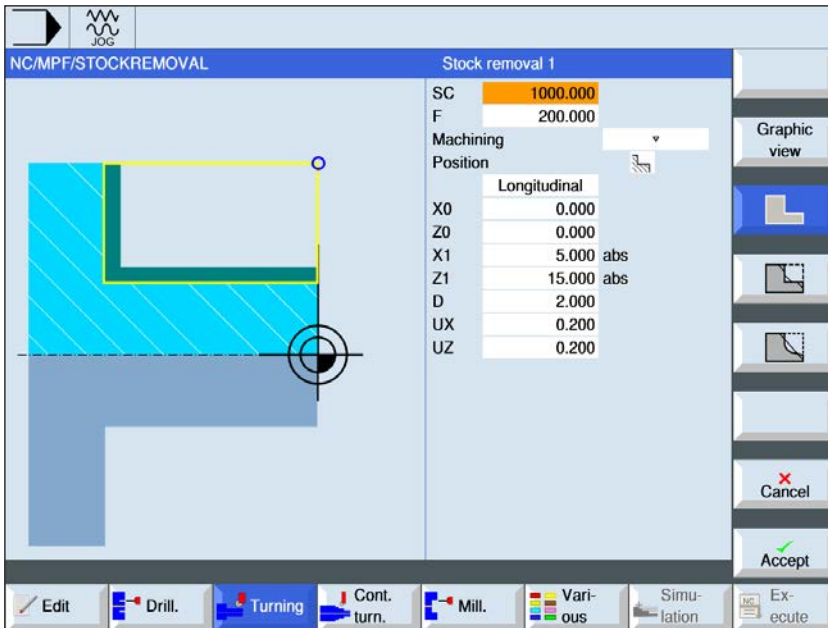

The "Select" button gives you the option to change parameters and/or units. To do this move the cursor to the appropriate field and press button.

Select machining cycle

For each desired movement press the corresponding softkey. The limits are shown by the control system.

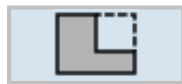

- Machining 1

Parameter	Description	Unit
SC	Safety distance	mm
F	Feed: the enabled feed type is retained	
Processing	<ul style="list-style-type: none"> • ▾ Roughing • ▾ ▾ Finishing 	
Position	Machining position	

Parameter	Description	Unit
Machining direction	alternating machining direction <ul style="list-style-type: none"> • Plane • Longitudinally 	
X0 Z0	Reference point in X Ø (absolute, always diameter) Reference point in Z (absolute)	mm
X1 Z1	End point X (absolute) or endpoint X referred to X0 (incremental) End point Z (absolute) or endpoint Z referred to Z0 (incremental)	
D	Maximum infeed depth - (not for ▽ ▽ ▽ finishing)	mm
UX	Finishing allowance in X- (not for ▽ ▽ ▽ finishing)	mm
UZ	Finishing allowance in Z- (not for ▽ ▽ ▽ finishing)	mm

**Instructions:**

For G-code, there is only this one grooving cycle CYCLE951 with the different input masks for 1, 2 and 3.



Machine 2 (CYCLE951)

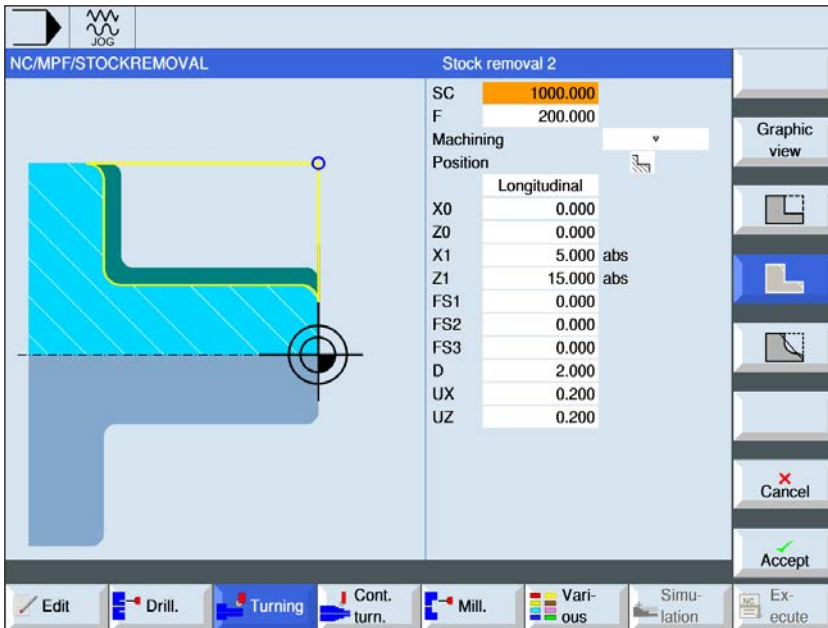

The "Select" button gives you the option to change parameters and/or units. To do this move the cursor to the appropriate field and press button.

Select machining cycle

For each desired movement press the corresponding softkey. The limits are shown by the control system.



- Machining 2

Parameter	Description	Unit
SC	Safety distance	
F	Feed: the enabled feed type is retained	
Machining	<ul style="list-style-type: none"> • ▾ Roughing • ▾ ▾ Finishing 	
Position	Machining position	

Parameter	Description	Unit
Machining direction	alternating machining direction <ul style="list-style-type: none"> • Plane • Longitudinally 	
X0 Z0	Reference point in X Ø (absolute, always diameter) Reference point in Z (absolute)	mm
X1 Z1	End point X (absolute) or endpoint X referred to X0 (incremental) End point Z (absolute) or endpoint Z referred to Z0 (incremental)	
D	Maximum infeed depth - (not for ▽ ▽ ▽ finishing)	mm
UX	Finishing allowance in X- (not for ▽ ▽ ▽ finishing)	mm
UZ	Finishing allowance in Z- (not for ▽ ▽ ▽ finishing)	mm
FS1...FS3 or R1...R3	Bevel width (FS1...FS3) or rounding radius (R1...R3)	mm

**Instructions:**

For G-code, there is only this one grooving cycle CYCLE951 with the different input masks for 1, 2 and 3.



Machine 3 (CYCLE951)

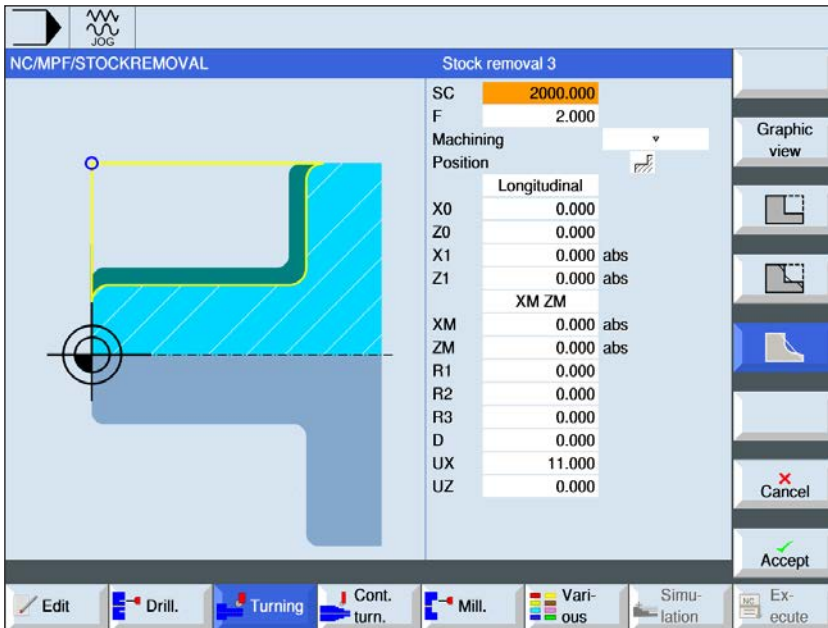

The "Select" button gives you the option to change parameters and/or units. To do this move the cursor to the appropriate field and press button.

Select machining cycle

For each desired movement press the corresponding softkey. The limits are shown by the control system.



- Machining 3

Parameter	Description	Unit
SC	Safety distance	
F	Feed: the enabled feed type is retained	
Machining	<ul style="list-style-type: none"> • ▾ Roughing • ▾ ▾ Finishing 	
Position	Machining position	

Parameter	Description	Unit
Machining direction	alternating machining direction <ul style="list-style-type: none"> • Plane • Longitudinally 	
X0 Z0	Reference point in X \emptyset (absolute, always diameter) Reference point in Z (absolute)	mm
X1 Z1	End point X (absolute) or endpoint X referred to X0 (incremental) End point Z (absolute) or endpoint Z referred to Z0 (incremental)	
D	Maximum infeed depth - (not for ▽ ▽ ▽ finishing)	mm
UX	Finishing allowance in X- (not for ▽ ▽ ▽ finishing)	mm
UZ	Finishing allowance in Z- (not for ▽ ▽ ▽ finishing)	mm
FS1...FS3 or R1...R3	Bevel width (FS1...FS3) or rounding radius (R1...R3)	mm
Interim point parameter selection	The interim point can be defined by positional or angle details. The following combinations are possible <ul style="list-style-type: none"> • XM ZM • XM α1 • XM α2 • α1 ZM • α2 ZM • α1 α2 	
XM	Interim point X \emptyset (absolute) or interim point X relative to X0 (incremental)	
ZM	Interim point Z (absolute or incremental)	
α 1 α 2	1st bevel angle 2nd bevel angle	degrees

Instructions:

For G-code, there is only this one grooving cycle CYCLE951 with the different input masks for 1, 2 and 3.



Cycle description

- 1 The control system positions the tool in the spindle axis in rapid traverse (G0) to the safety distance above the reference point.
- 2 The tool moves back to the 1st infeed depth in rapid traverse.
3. The first cut is machined with the machining feed.
4. The tool traces the contour with machine feed or lifts off in rapid traverse (see Roughing section).
5. The tool moves in rapid traverse to the start point for the next infeed depth.
6. The next cut is machined with the machining feed.
7. Steps 4 to 6 are repeated until the final depth is reached.
- 8 The tool withdraws to the safety distance in rapid traverse.



Grooving 1 (CYCLE930)

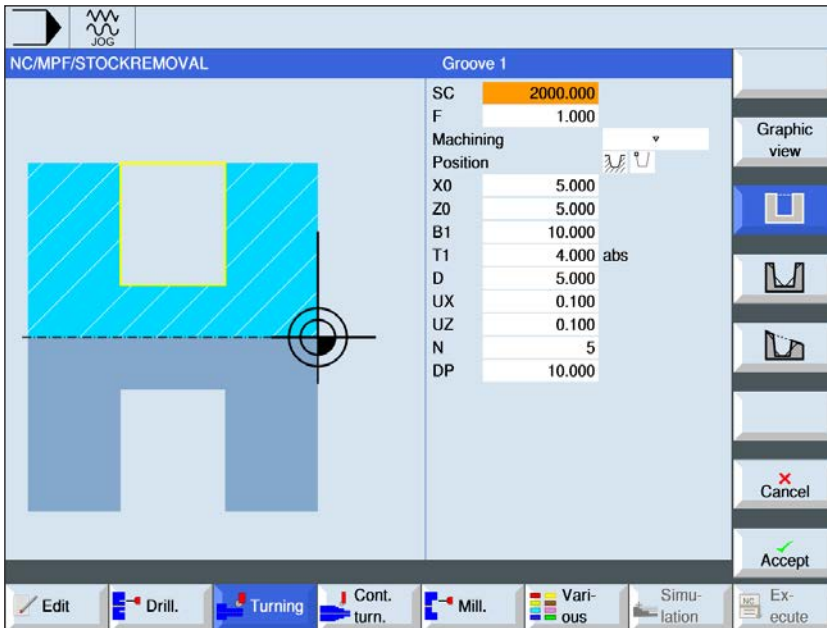

The "Select" button gives you the option to change parameters and/or units. To do this move the cursor to the appropriate field and press button.

Select grooving cycle

For each desired movement press the corresponding softkey. The limits are shown by the control system.



- Grooving 1

Parameter	Description	Unit
SC	Safety distance	
F	Feed: the enabled feed type is retained	
Machining	<ul style="list-style-type: none"> • ▾ Roughing • ▾ ▾ Finishing • ▾ + ▾ ▾ (Roughing and finishing) 	
Position	Machining position	

Parameter	Description	Unit
X0 Z0	Reference point in X Ø Reference point in Z	mm
B1	Groove width	mm
T1	Groove depthØ (abs) or groove depth relative to X0 (incr.)	
D	<ul style="list-style-type: none"> • Maximum infeed depth for penetration – (only for ▽ and ▽+ ▽ ▽ ▽) • For zero: Penetration in a single cut – (only for ▽ and ▽+ ▽ ▽ ▽) D = 0: 1. cut is made directly to final depth D1. D = 0: The 1st and 2nd cuts are made alternately around the infeed depth D, to achieve better chip flow and avoid the tool breaking, see approach/withdrawal when roughing. An alternating cut is not possible if the tool can reach the bottom of the groove at only one position.	
UX or U	Finishing pass in X or finishing pass in X and Z – (only for ▽ and ▽+ ▽ ▽ ▽)	mm
UZ	Finishing pass in Z – (for UX, only for ▽ and ▽+ ▽ ▽ ▽)	
N	Number of grooves (N = 1....65535)	
DP	Groove spacing (incr.) For N = 1, DP is not shown	mm

Instructions:

For G-code, there is only this one grooving cycle CYCLE930 with the different input masks for 1, 2 and 3.





Grooving 2 (CYCLE30)

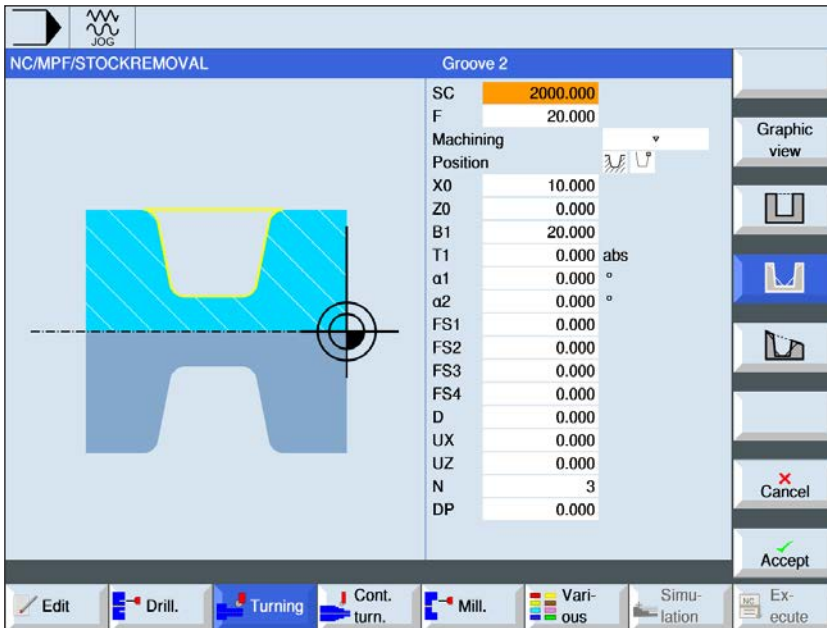

The "Select" button gives you the option to change parameters and/or units. To do this move the cursor to the appropriate field and press button.

Select grooving cycle

For each desired movement press the corresponding softkey. The limits are shown by the control system.



- Grooving 2

Parameter	Description	Unit
SC	Safety distance	
F	Feed: the enabled feed type is retained	
Machining	<ul style="list-style-type: none"> • ▾ Roughing • ▾ ▾ ▾ Finishing • ▾ + ▾ ▾ ▾ (Roughing and finishing) 	
Position	Machining position	

Parameter	Description	Unit
X0 Z0	Reference point in X Ø Reference point in Z	mm
B1	Groove width	mm
T1	Groove depthØ (abs) or groove depth relative to X0 (incr.)	
D	<ul style="list-style-type: none"> • Maximum infeed depth for penetration – (only for ▽ and ▽+▽▽▽) • For zero: Penetration in a single cut – (only for ▽ and ▽+▽▽▽) D = 0: 1. cut is made directly to final depth D1. D = 0: The 1st and 2nd cuts are made alternately around the infeed depth D, to achieve better chip flow and avoid the tool breaking, see approach/withdrawal when roughing. An alternating cut is not possible if the tool can reach the bottom of the groove at only one position.	
UX or U	Finishing pass in X or finishing pass in X and Z – (only for ▽ and ▽+▽▽▽)	mm
UZ	Finishing pass in Z – (for UX, only for ▽ and ▽+▽▽▽)	
N	Number of grooves (N = 1...65535)	
DP	Groove spacing (incr.) For N = 1, DP is not shown	mm
α1, α2	Edge angle 1 or edge angle 2 Asymmetrical grooves can be described by separate angles. The angles can take values between 0 and < 90°	degrees
FS1...FS4 R1...R4	or Bevel width (FS1...FS4) or rounding radius (R1...R4)	mm

Instructions:

For G-code, there is only this one grooving cycle CYCLE930 with the different input masks for 1, 2 and 3.





Grooving 3 (CYCLE930)

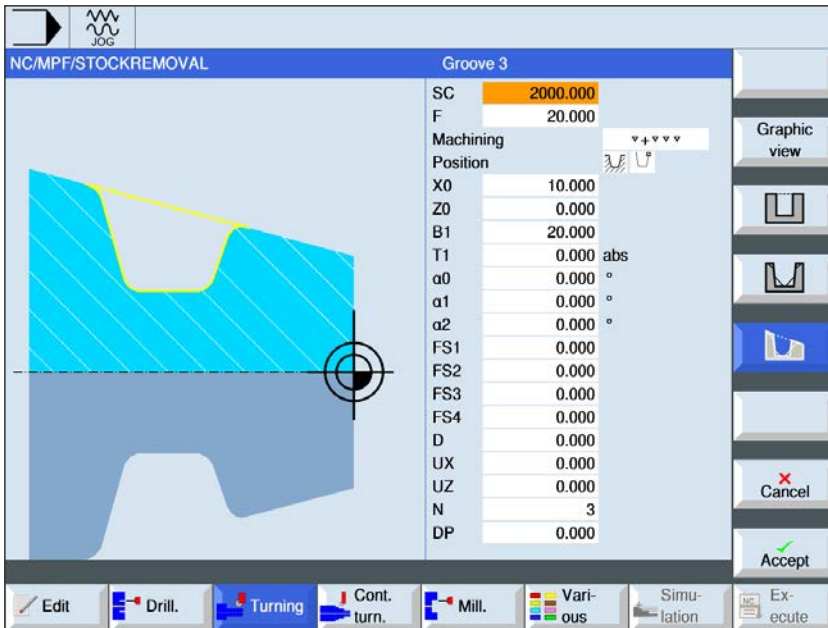

The "Select" button gives you the option to change parameters and/or units. To do this move the cursor to the appropriate field and press button.

Select grooving cycle

For each desired movement press the corresponding softkey. The limits are shown by the control system.



- Grooving 3

Parameter	Description	Unit
SC	Safety distance	
F	Feed: the enabled feed type is retained	
Machining	<ul style="list-style-type: none"> • ▾ Roughing • ▾ ▾ ▾ Finishing • ▾ + ▾ ▾ ▾ (Roughing and finishing) 	
Position	Machining position	

Parameter	Description	Unit
X0 Z0	Reference point in X Ø Reference point in Z	mm
B1	Groove width	mm
T1	Groove depth Ø (abs) or groove depth relative to X0 (incr.)	
D	<ul style="list-style-type: none"> • Maximum infeed depth for penetration – (only for ▽ and ▽+ ▽ ▽ ▽) • For zero: Penetration in a single cut – (only for ▽ and ▽+ ▽ ▽ ▽) D = 0: 1. cut is made directly to final depth D1. D = 0: The 1st and 2nd cuts are made alternately around the infeed depth D, to achieve better chip flow and avoid the tool breaking, see approach/withdrawal when roughing. An alternating cut is not possible if the tool can reach the bottom of the groove at only one position.	
UX or U	Finishing pass in X or finishing pass in X and Z – (only for ▽ and ▽+ ▽ ▽ ▽)	mm
UZ	Finishing pass in Z – (for UX, only for ▽ and ▽+ ▽ ▽ ▽)	
N	Number of grooves (N = 1...65535)	
DP	Groove spacing (incr.) For N = 1, DP is not shown	mm
α0	Oblique angle	degrees
α1, α2	Edge angle 1 or edge angle 2) Asymmetrical grooves can be described by separate angles. The angles can take values between 0 and < 90°	degrees
FS1...FS4 R1...R4	or Bevel width (FS1...FS4) or rounding radius (R1...R4)	mm

Instructions:

For G-code, there is only this one grooving cycle CYCLE930 with the different input masks for 1, 2 and 3.



Roughing cycle description

1. The tool moves in rapid traverse only to the startpoint calculated within the cycle.
2. The tool cuts a groove in the center by the infeed depth D .
- 3 The tool withdraws by $D +$ the safety distance in rapid traverse.
4. The tool cuts a groove in addition to the first groove by the infeed depth $2 \cdot D$.
- 5 The tool withdraws by $D +$ the safety distance in rapid traverse.
6. The tool cuts grooves alternately in the 1st and 2nd grooves by the infeed depth $2 \cdot D$, until the final depth $D1$ is reached.
Between the individual grooves, the tool withdraws in rapid traverse each time by $D +$ the safety distance. After the last groove, the tool withdraws in rapid traverse to the safety distance.
7. All further grooves are finished directly to the final depth $D1$.
Between the individual grooves, the tool withdraws in rapid traverse each time to the safety distance.

Finishing cycle description

1. The tool moves in rapid traverse only to the startpoint calculated within the cycle.
2. The tool moves with machining feed down to an edge and then advances on the ground to the center.
- 3 The tool withdraws to the safety distance in rapid traverse.
4. The tool moves with machining feed along to the other edge and then advances on the ground to the center.
- 5 The tool withdraws to the safety distance in rapid traverse.



Free groove (CYCLE940)

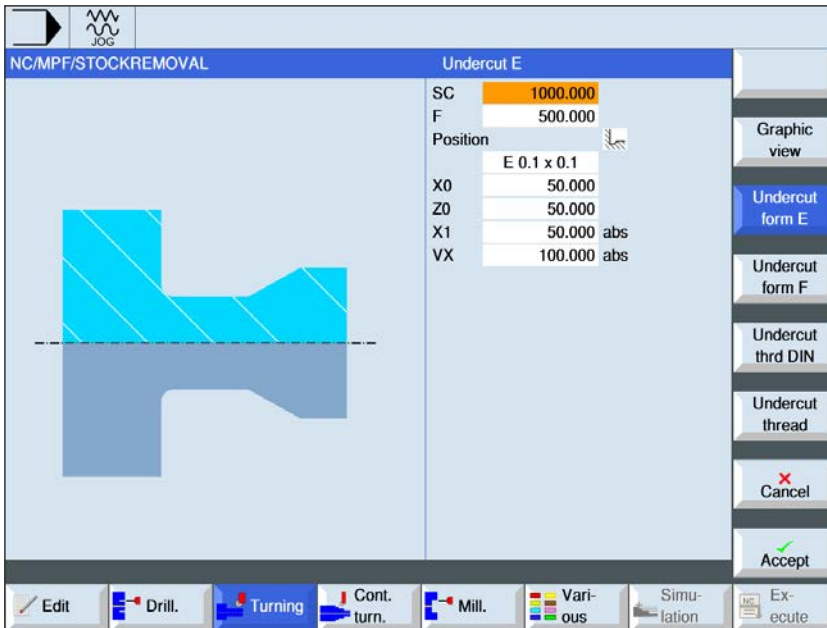

The "Select" button gives you the option to change parameters and/or units. To do this move the cursor to the appropriate field and press button.

Parameter	Description	Unit
SC	Safety distance	
F	Feed: the enabled feed type is retained	
Position	Machining position: Form E and Form F	
Free grooving variable according to DIN table	e.g.: E1.0 x 0.4 (free groove form E) e.g.: F0.6 x 0.3 (free groove form F)	
X0 Z0	Coordinate of the reference point (absolute) Reference point X Ø Reference point Z	mm
X1	Allowance in X Ø (abs) or allowance in X (incr.)	mm
Z1	Allowance in Z (abs) or allowance in Z (incr.) - (only for free groove form F)	mm
VX	Plane Ø (abs) or plane (incr.)	mm

Grooving cycle description

1. The tool moves in rapid traverse only to the startpoint calculated within the cycle.
2. Free grooving is finished in a single step with machining feed, beginning at the edge and ending at plane VX.
- 3 The tool withdraws to the start point in rapid traverse.



Free groove GDIN (CYCLE940)

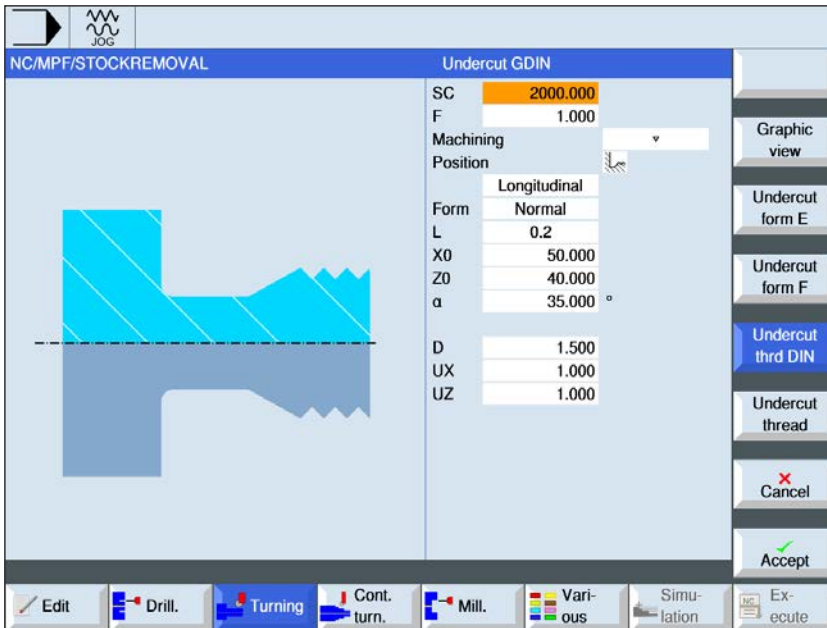

The "Select" button gives you the option to change parameters and/or units. To do this move the cursor to the appropriate field and press button.

Parameter	Description	Unit
SC	Safety distance	mm
F	Feed: the enabled feed type is retained	
Machining	<ul style="list-style-type: none"> ▾ Roughing ▾ ▾ ▾ Finishing ▾ + ▾ ▾ ▾ (Roughing and finishing) 	
Position	Machining position:	
Direction	Machining direction: <ul style="list-style-type: none"> • longitudinally • parallel to the contour 	
Form	Machining form: <ul style="list-style-type: none"> • normal • short 	
P	Thread pitch (select or enter from DIN table provided)	mm/rev

Parameter	Description	Unit
X0 Z0	Coordinate of the reference point (absolute).	mm
α	Penetration angle	degrees
VX	Plane \emptyset (absolute) or plane (incremental) - (only for $\nabla \nabla \nabla$ and $\nabla + \nabla \nabla \nabla$).	mm
D	maximum infeed depth – (only for ∇ and $\nabla + \nabla \nabla \nabla$).	mm
U or UX	Finishing pass in X or Finishing pass in X and Z – (only for ∇ and $\nabla + \nabla \nabla \nabla$).	mm
UZ	Finishing pass in Z – (only for UX, ∇ and $\nabla + \nabla \nabla \nabla$).	mm

Grooving cycle description

1. The tool moves in rapid traverse only to the startpoint calculated within the cycle.
2. The 1st cut is done with machine feed beginning at the thread along the form of the thread free groove as far as the safety distance.
3. The tool moves back to the next start position in rapid traverse.
4. Steps 2 to 3 are repeated until the thread groove is finished completely.
5. The tool withdraws to the start point in rapid traverse.

When finishing, the tool moves to the plane VX.



Free groove thread (CYCLE940)

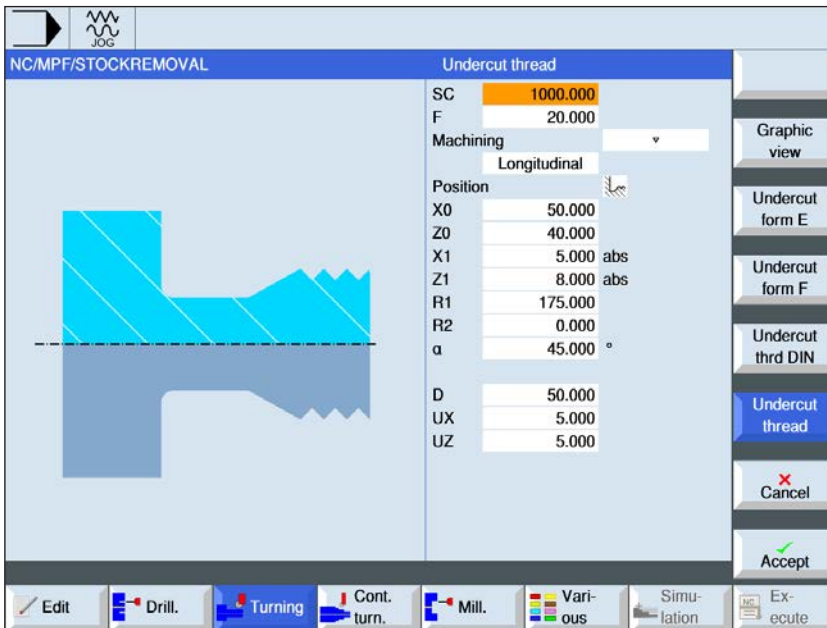

The "Select" button gives you the option to change parameters and/or units. To do this move the cursor to the appropriate field and press button.

Parameter	Description	Unit
SC	Safety distance	mm
F	Feed: the enabled feed type is retained	
Machining	<ul style="list-style-type: none"> ▾ Roughing ▾ ▾ ▾ Finishing ▾ + ▾ ▾ ▾ (Roughing and finishing) 	
Position	Machining position:	
Direction	Machining direction: <ul style="list-style-type: none"> • longitudinally • parallel to the contour 	
X0 Z0	Coordinate of the reference point (absolute).	mm

Parameter	Description	Unit
X1	Groove depth relative to X Ø (absolute) or groove depth relative to X (incremental)	
Z1	Allowance Z (absolute or incremental)	
R1 R2	Rounding radius 1 Rounding radius 2	mm
α	Penetration angle	degrees
VX	Plane Ø (absolute) or plane (incremental) - (only for ▽ ▽ ▽ and ▽ + ▽ ▽ ▽).	mm
D	maximum infeed depth – (only for ▽ and ▽ + ▽ ▽ ▽).	mm
U or UX	Finishing pass in X or Finishing pass in X and Z – (only for ▽ and ▽ + ▽ ▽ ▽).	mm
UZ	Finishing pass in Z – (only for UZ, ▽ and ▽ + ▽ ▽ ▽).	mm

Grooving cycle description

1. The tool moves in rapid traverse only to the startpoint calculated within the cycle.
2. The 1st cut is done with machine feed beginning at the thread along the form of the thread free groove as far as the safety distance.
3. The tool moves back to the next start position in rapid traverse.
4. Steps 2 to 3 are repeated until the thread groove is finished completely.
5. The tool withdraws to the start point in rapid traverse.

When finishing, the tool moves to the plane VX.



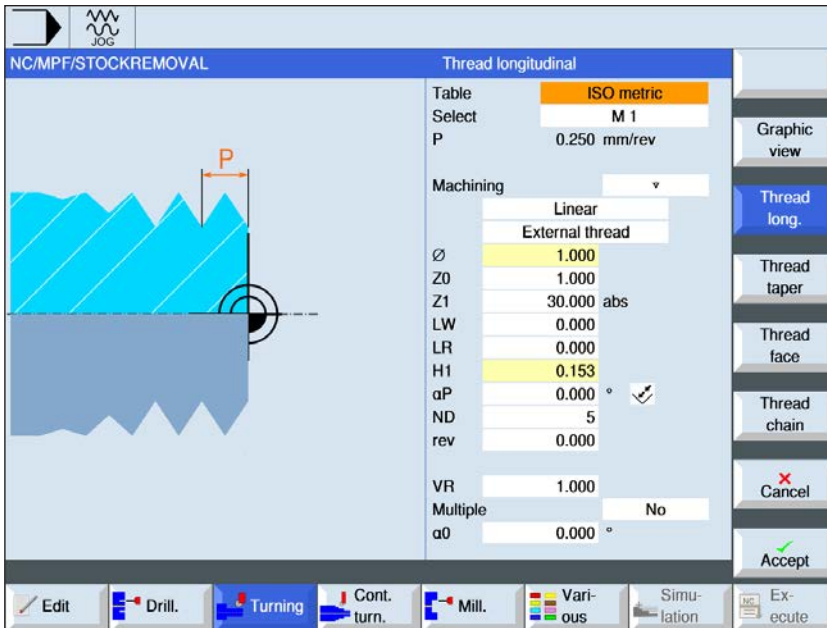

Longitudinal thread (CYCLE99)



The "Select" button gives you the option to change parameters and/or units. To do this move the cursor to the appropriate field and press button.

Parameter	Description	Unit
Table	Thread selection table: <ul style="list-style-type: none"> • none • ISO metric • Whitworth BSW • Whitworth BSP • UNC 	
Selection	Selection of the table value e.g.: <ul style="list-style-type: none"> • M1; M5; etc. (ISO metric) • W1/8"; etc. (Whitworth BSW) • G 1 3/4"; etc. (Whitworth BSP) • N8 - 32 UNC; etc. (UNC) (also see thread table with respective pitches)	
P	Selection of pitch/threads for "none" table or details of pitch/threads according to the thread table selection: <ul style="list-style-type: none"> • Pitch in mm/revolution • Pitch in inches/revolution • Threads per inch • Pitch in MODUL. 	Threads/" MODULE mm/rev inches/rev

Parameter	Description	Unit
G	<p>Change of pitch per revolution - (only for P = mm/rev or in/rev) G = 0: The pitch P is unchanged. G > 0: The pitch P is increased per revolution by the value G. G < 0: The pitch P is decreased per revolution by the value G. If the start and end pitch of the thread are known, the pitch change for programming can be calculated as follows:</p> $G = \frac{ P_e^2 - P^2 }{2 * Z_1} \text{ [mm/U2]}$ <p>This also means: Pe: Final pitch [mm/rev] P: Initial pitch [mm/rev] Z₁: Thread length [mm] A large pitch results in a greater distance between threads on the workpiece.</p>	
Machining	<ul style="list-style-type: none"> ▽ Roughing ▽▽ Finishing ▽+▽▽ (Roughing and finishing) 	
infeed (only for ▽ and ▽+▽▽)	<ul style="list-style-type: none"> Linear: infeed with constant cutting depth Degrressive: infeed with constant chip cross-section 	
Thread	Internal thread and external thread	
X0	Reference point X from thread table Ø (absolute).	mm
Z0	Reference point Z (abs)	mm
Z1	End point of the thread (absolute) or thread length (incremental).	mm
LW	<p>Thread run-in (incremental) Thread start point is the preset reference point (X0, Z0) around the thread run-in W. You can use the thread run-in if you want to begin the individual cuts somewhat earlier, in order also to finish the thread start exactly.</p>	mm
or LW2	<p>Thread run-in (incremental) You can use the thread run-in if you cannot approach the thread to be finished from the side, but must penetrate the material (Example: lubrication groove on a shaft).</p>	mm

Parameter	Description	Unit
or LW2 = LR	Thread run-in = thread run-out (incremental)	mm
LR	Thread run-out (incremental) You can use the hthread run-out if you want to move out at an angle at the end of the thread (Example: lubrication groove on a shaft).	mm
H1	Thread depth from thread table (incremental)	mm
DP	Infeed angle as thread (incr.) – (alternatively for infeed angle as angle) DP $\alpha > 0$: Infeed along the rear thread DP $\alpha < 0$: Infeed along the front thread	
or αP	Infeed angle as angle – (alternatively for infeed angle as thread) $\alpha > 0$: Infeed along the rear thread. $\alpha < 0$: Infeed along the front thread. $\alpha = 0$: infeed at right angles to the cutting direction. If infeed along the threads, the absolute value of this parameter must be a maximum of half the tool thread angle.	degrees
	Infeed along the thread	
	Infeed with alternating thread (alternatively) Instead of along a thread, you can also infeed with alternating threads, so as not always to stress the same cutting edge of the tool. In this way, you can increase the working life of the tool. $\alpha > 0$: Start at the rear thread $\alpha < 0$: Start at the front thread	
D1 or ND (only for ∇ and $\nabla + \nabla \nabla \nabla$)	First infeed depth or number of roughing cuts. When switching between the number of roughing cuts and the first infeed, the corresponding value is shown in each case.	mm
U	Finishing pass in X and Z – (only for ∇ and $\nabla + \nabla \nabla \nabla$).	mm
NN	Number of empty cuts - (only for $\nabla \nabla \nabla$ and $\nabla + \nabla \nabla \nabla$)	
VR	Reverse distance (incremental)	mm

Parameter	Description	Unit
Multi-thread	<ul style="list-style-type: none"> • yes • no 	
$\alpha 0$	Start angle offset	
N	Number of threads The threads are distributed evenly along the rotating part, with the first thread always being placed at 0°.	
DA	Thread change depth (incr.) First machine all threads sequentially to the thread change depth, then machine all threads sequentially to depth 2 · machine DA etc. until the final depth is reached. DA = 0: Thread change depth is not included, i.e. every thread completely before machining the next thread.	
Machining	<ul style="list-style-type: none"> • Complete or • starting from thread N1 N1 (1...4) Start thread N1 = 1...N or <ul style="list-style-type: none"> • only thread NX NX (1...4) 1 from N threads	

Thread table

ISO_METRIC		WHITWORTH_BSW		WHITWORTH_BSP		UNC	
M 1	0,250	W 1/16"	60,000	G 1/16"	28.000	N 1 - 64 UNC	64.000
M 1.2	0.250	W 3/32"	48.000	G 1/8"	28.000	N 2 - 56 UNC	56.000
M 1.6	0.350	W 1/8"	40.000	G 1/4"	19.000	N 3 - 48 UNC	48.000
M 2	0.400	W 5/32"	32.000	G 3/8"	19.000	N 4 - 40 UNC	40.000
M 2.5	0.450	W 3/16"	24.000	G 1/2"	14.000	N 5 - 40 UNC	40.000
M 3	0.500	W 7/32"	24.000	G 5/8"	14.000	N 6 - 32 UNC	32.000
M 3.5	0.600	W 1/4"	20.000	G 3/4"	14.000	N 8 - 32 UNC	32.000
M 4	0.700	W 5/16"	18.000	G 7/8"	14.000	N 10 - 24 UNC	24.000
M 4.5	0.750	W 3/8"	16.000	G 1"	11.000	N 12 - 24 UNC	24.000
M 5	0.800	W 7/16"	14.000	G 1 1/8"	11.000	1/4" - 20 UNC	20.000
M 6	1.000	W 1/2"	12.000	G 1 1/4"	11.000	5/16" - 18 UNC	18.000
M 8	1.250	W 9/16"	12.000	G 1 3/8"	11.000	3/8" - 16 UNC	16.000
M 10	1.500	W 5/8"	11.000	G 1 1/2"	11.000	7/16" - 14 UNC	14.000
M 12	1.750	W 3/4"	10.000	G 1 3/4"	11.000	1/2" - 13 UNC	13.000
M 14	2.000	W 7/8"	9.000	G 2"	11.000	9/16" - 12 UNC	12.000
M 16	2.000	W 1"	8.000	G 2 1/4"	11.000	5/8" - 11 UNC	11.000
M 18	2.500	W 1 1/8"	7.000	G 2 1/2"	11.000	3/4" - 10 UNC	10.000
M 20	2.500	W 1 1/4"	7.000	G 2 3/4"	11.000	7/8" - 9 UNC	9.000
M 22	2.500	W 1 3/8"	6.000	G 3"	11.000	1" - 8 UNC	8.000
M 24	3.000	W 1 1/2"	6.000	G 3 1/4"	11.000	1 1/8" - 7 UNC	7.000
M 27	3.000	W 1 5/8"	5.000	G 3 1/2"	11.000	1 1/4" - 7 UNC	7.000
M 30	3.500	W 1 3/4"	5.000	G 3 3/4"	11.000	1 3/8" - 6 UNC	6.000
M 33	3.500	W 1 7/8"	4.500	G 4"	11.000	1 1/2" - 6 UNC	6.000
M 36	4.000	W 2"	4.500	G 5"	11.000	1 3/4" - 5 UNC	5.000
M 39	4.000	W 2 1/4"	4.000	G 6"	11.000	2" - 4 1/2 UNC	4.500
M 42	4.500	W 2 1/2"	4.000			2 1/4" - 4 1/2 UNC	4.500
M 45	4.500	W 2 3/4"	3.500			2 1/2" - 4 UNC	4.000
M 48	5.000	W 3"	3.500			2 3/4" - 4 UNC	4.000
M 52	5.000	W 3 1/4"	3.250			3" - 4 UNC	4.000
M 56	5.500	W 3 1/2"	3.250			3 1/4" - 4 UNC	4.000
M 60	5.500	W 3 3/4"	3.000			3 1/2" - 4 UNC	4.000
M 64	6.000	W 4"	3.000			3 3/4" - 4 UNC	4.000
M 68	6.000					4" - 4 UNC	4.000

Grooving cycle description

1. The tool moves in rapid traverse to the start-point calculated within the cycle.
2. Thread with advance:
The tool moves in rapid traverse to the first start position placed by the thread advance LW.
Thread with run-in:
The tool moves in rapid traverse to the start position placed by the thread advance LW2.
3. The first cut is finished with pitch P to the thread run-out LR.
4. Thread with advance:
The tool moves in rapid traverse to the withdrawal distance VR and then to the next start position.
Thread with run-in:
The tool moves in rapid traverse to the withdrawal distance VR and again to the start position.
5. Steps 3 to 4 are repeated until the thread is finished completely.
- 6 The tool withdraws in rapid traverse to the retraction plane.
The thread machining can be interrupted at any time with the "Fast lift" function. This guarantees that the tool does not damage the thread during lifting.



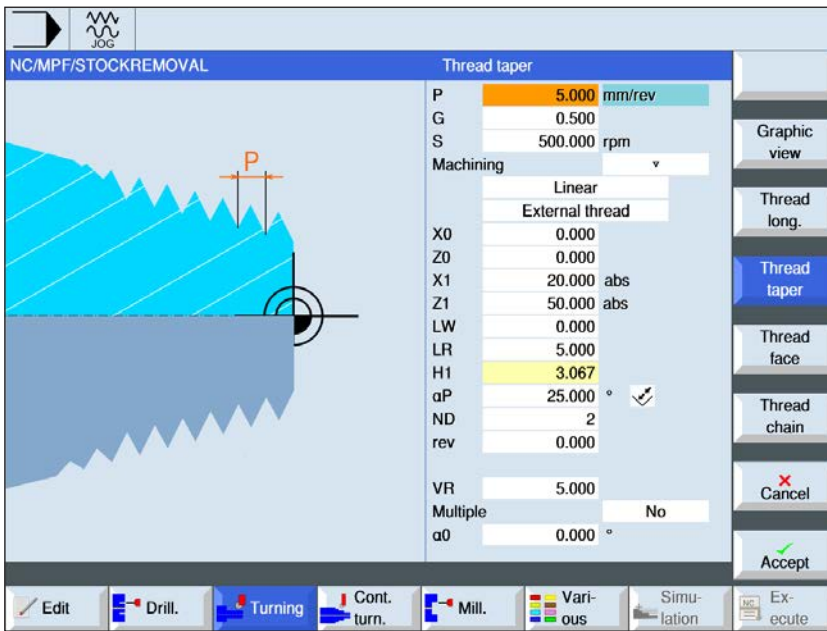

Tapered thread (CYCLE99)



The "Select" button gives you the option to change parameters and/or units. To do this move the cursor to the appropriate field and press button.

Parameter	Description	Unit
S / V	Spindle speed or constant cutting speed	rpm m/min
P	Selection of pitch/threads for "none" table or details of pitch/threads according to the thread table selection: <ul style="list-style-type: none"> • Pitch in mm/revolution • Pitch in inches/revolution • Threads per inch • Pitch in MODUL. 	Threads/" MODULE mm/rev inches/rev

Parameter	Description	Unit
G	<p>Change of pitch per revolution - (only for P = mm/rev or in/rev) G = 0: The pitch P is unchanged. G > 0: The pitch P is increased per revolution by the value G. G < 0: The pitch P is decreased per revolution by the value G. If the start and end pitch of the thread are known, the pitch change for programming can be calculated as follows:</p> $G = \frac{ P_{e^2} - P^2 }{2 * Z_1} \text{ [mm/U2]}$ <p>This also means: Pe: Final pitch [mm/rev] P: Initial pitch [mm/rev] Z₁: Thread length [mm] A large pitch results in a greater distance between threads on the workpiece.</p>	
Machining	<ul style="list-style-type: none"> ▽ Roughing ▽▽ Finishing ▽+▽▽ (Roughing and finishing) 	
Infeed (only for ▽ and ▽+▽▽▽)	<ul style="list-style-type: none"> Linear: infeed with constant cutting depth Degressive: infeed with constant chip cross-section 	
Thread	Internal thread and external thread	
X0	Reference point X from thread table Ø (absolute).	mm
Z0	Reference point in Z	mm
X1 or X1α	End point X Ø (abs) or end point relative to X0 (incr.) or thread angle Incremental dimension: The symbol is analyzed.	mm or degrees
Z1	End point of the thread (absolute) or thread length (incremental).	mm
LW	Thread run-in (incremental) Thread start point is the preset reference point (X0, Z0) around the thread run-in W. You can use the thread run-in if you want to begin the individual cuts somewhat earlier, in order also to finish the thread start exactly.	mm
or LW2	Thread run-in (incremental) You can use the thread run-in if you cannot approach the thread to be finished from the side, but must penetrate the material (Example: lubrication groove on a shaft).	mm
or LW2 = LR	Thread run-in = thread run-out (incremental)	mm

Parameter	Description	Unit
LR	Thread run-out (incremental) You can use the thread run-out if you want to move out at an angle at the end of the thread (Example: lubrication groove on a shaft).	mm
H1	Thread depth from thread table (incremental)	mm
DP	Infeed angle as thread (incr.) – (alternatively for infeed angle as angle) DP $\alpha > 0$: Infeed along the rear thread DP $\alpha < 0$: Infeed along the front thread	
or αP	Infeed angle as angle – (alternatively for infeed angle as thread) $\alpha > 0$: Infeed along the rear thread. $\alpha < 0$: Infeed along the front thread. $\alpha = 0$: infeed at right angles to the cutting direction. If infeed along the threads, the absolute value of this parameter must be a maximum of half the tool thread angle.	degrees
	Infeed along the thread	
	Infeed with alternating thread (alternatively) Instead of along a thread, you can also infeed with alternating threads, so as not always to stress the same cutting edge of the tool. In this way, you can increase the working life of the tool. $\alpha > 0$: Start at the rear thread $\alpha < 0$: Start at the front thread	
D1 or ND (only for ∇ and $\nabla + \nabla \nabla \nabla$)	First infeed depth or number of roughing cuts. When switching between the number of roughing cuts and the first infeed, the corresponding value is shown in each case.	mm
U	Finishing allowance in X and Z – (only for ∇ and $\nabla + \nabla \nabla \nabla$).	mm
NN	Number of empty cuts - (only for ∇ and $\nabla + \nabla \nabla \nabla$)	
VR	Reverse distance (incremental)	mm

Parameter	Description	Unit
Multi-thread	<ul style="list-style-type: none"> • yes • no 	
$\alpha 0$	Start angle offset	
N	Number of threads The threads are distributed evenly along the rotating part, with the first thread always being placed at 0°.	
DA	Thread change depth (incr.) First machine all threads sequentially to the thread change depth, then machine all threads sequentially to depth 2 · machine DA etc. until the final depth is reached. DA = 0: Thread change depth is not included, i.e. every thread completely before machining the next thread.	
Machining	<ul style="list-style-type: none"> • Complete or • starting from thread N1 N1 (1...4) Start thread N1 = 1...N or <ul style="list-style-type: none"> • only thread NX NX (1...4) 1 from N threads	

Cycle description - Tapered thread

1. The tool moves in rapid traverse to the start-point calculated within the cycle.
2. Thread with advance:
The tool moves in rapid traverse to the first start position placed by the thread advance LW.
Thread with run-in:
The tool moves in rapid traverse to the start position placed by the thread advance LW2.
3. The first cut is finished with pitch P to the thread run-out LR.
4. Thread with advance:
The tool moves in rapid traverse to the withdrawal distance VR and then to the next start position.
Thread with run-in:
The tool moves in rapid traverse to the withdrawal distance VR and again to the start position.
5. Steps 3 to 4 are repeated until the thread is finished completely.
6. The tool withdraws in rapid traverse to the retraction plane.
The thread machining can be interrupted at any time with the "Fast lift" function. This guarantees that the tool does not damage the thread during lifting.



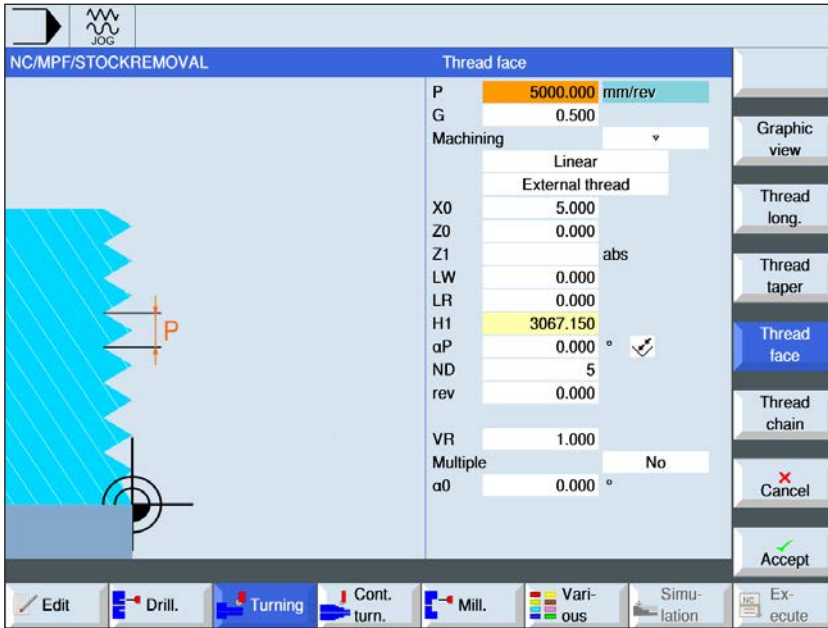

Transverse thread (CYCLE99)



The "Select" button gives you the option to change parameters and/or units. To do this move the cursor to the appropriate field and press button.

Parameter	Description	Unit
P	Selection of pitch/threads for "none" table or details of pitch/threads according to the thread table selection: <ul style="list-style-type: none"> • Pitch in mm/revolution • Pitch in inches/revolution • Threads per inch • Pitch in MODUL. 	Threads/" MODULE mm/rev inches/rev

Parameter	Description	Unit
G	<p>Change of pitch per revolution - (only for P = mm/rev or in/rev) G = 0: The pitch P is unchanged. G > 0: The pitch P is increased per revolution by the value G. G < 0: The pitch P is decreased per revolution by the value G. If the start and end pitch of the thread are known, the pitch change for programming can be calculated as follows:</p> $G = \frac{ P_e^2 - P^2 }{2 * Z_1} \text{ [mm/U2]}$ <p>This also means: Pe: Final pitch [mm/rev] P: Initial pitch [mm/rev] Z₁: Thread length [mm] A large pitch results in a greater distance between threads on the workpiece.</p>	
Machining	<ul style="list-style-type: none"> ▽ Roughing ▽▽ Finishing ▽+▽▽ ((Roughing and finishing)) 	
Infeed (only for ▽+▽▽)	<ul style="list-style-type: none"> Linear: infeed with constant cutting depth Degressive: infeed with constant chip cross-section 	
Thread	Internal thread and external thread	
X0	Reference point X from thread table Ø (absolute).	mm
Z0	Reference point in Z	mm
Z1	End point of the thread (absolute) or thread length (incremental).	mm
LW	Thread run-in (incremental) Thread start point is the preset reference point (X0, Z0) around the thread run-in W. You can use the thread run-in if you want to begin the individual cuts somewhat earlier, in order also to finish the thread start exactly.	mm
or LW2	Thread run-in (incremental) You can use the thread run-in if you cannot approach the thread to be finished from the side, but must penetrate the material (Example: lubrication groove on a shaft).	mm

Parameter	Description	Unit
or LW2 = LR	Thread run-in = thread run-out (incremental)	mm
LR	Thread run-out (incremental) You can use the thread run-out if you want to move out at an angle at the end of the thread (Example: lubrication groove on a shaft).	mm
H1	Thread depth from thread table (incremental)	mm
DP	Infeed angle as thread (incr.) – (alternatively for infeed angle as angle) DP $\alpha > 0$: Infeed along the rear thread DP $\alpha < 0$: Infeed along the front thread	
or αP	Infeed angle as angle – (alternatively for infeed angle as thread) $\alpha > 0$: Infeed along the rear thread. $\alpha < 0$: Infeed along the front thread. $\alpha = 0$: infeed at right angles to the cutting direction. If infeed along the threads, the absolute value of this parameter must be a maximum of half the tool thread angle.	degrees
	Infeed along the thread	
	Infeed with alternating thread (alternatively) Instead of along a thread, you can also infeed with alternating threads, so as not always to stress the same cutting edge of the tool. In this way, you can increase the working life of the tool. $\alpha > 0$: Start at the rear thread $\alpha < 0$: Start at the front thread	
D1 or ND (only for ∇ and $\nabla + \nabla \nabla \nabla$)	First infeed depth or number of roughing cuts. When switching between the number of roughing cuts and the first infeed, the corresponding value is shown in each case.	mm
U	Finishing allowance in X and Z – (only for ∇ and $\nabla + \nabla \nabla \nabla$).	mm
NN	Number of empty cuts - (only for ∇ and $\nabla + \nabla \nabla \nabla$)	
VR	Reverse distance (incremental)	mm
Multi-thread	<ul style="list-style-type: none"> • yes • no 	

Parameter	Description	Unit
$\alpha 0$	Start angle offset	
N	Number of threads The threads are distributed evenly along the rotating part, with the first thread always being placed at 0°.	
DA	Thread change depth (incr.) First machine all threads sequentially to the thread change depth, then machine all threads sequentially to depth 2 · machine DA etc. until the final depth is reached. DA = 0: Thread change depth is not included, i.e. every thread completely before machining the next thread.	
Machining	<ul style="list-style-type: none"> • Complete or • starting from thread N1 N1 (1...4) Start thread N1 = 1...N or • only thread NX NX (1...4) 1 from N threads 	

Cycle description - Tapered thread

1. The tool moves in rapid traverse to the start-point calculated within the cycle.
2. Thread with advance:
The tool moves in rapid traverse to the first start position placed by the thread advance LW.
Thread with run-in:
The tool moves in rapid traverse to the start position placed by the thread advance LW2.
3. The first cut is finished with pitch P to the thread run-out LR.
4. Thread with advance:
The tool moves in rapid traverse to the withdrawal distance VR and then to the next start position.
Thread with run-in:
The tool moves in rapid traverse to the withdrawal distance VR and again to the start position.
5. Steps 3 to 4 are repeated until the thread is finished completely.
6. The tool withdraws in rapid traverse to the retraction plane.
The thread machining can be interrupted at any time with the "Fast lift" function. This guarantees that the tool does not damage the thread during lifting.



Chain thread (CYCLE99)

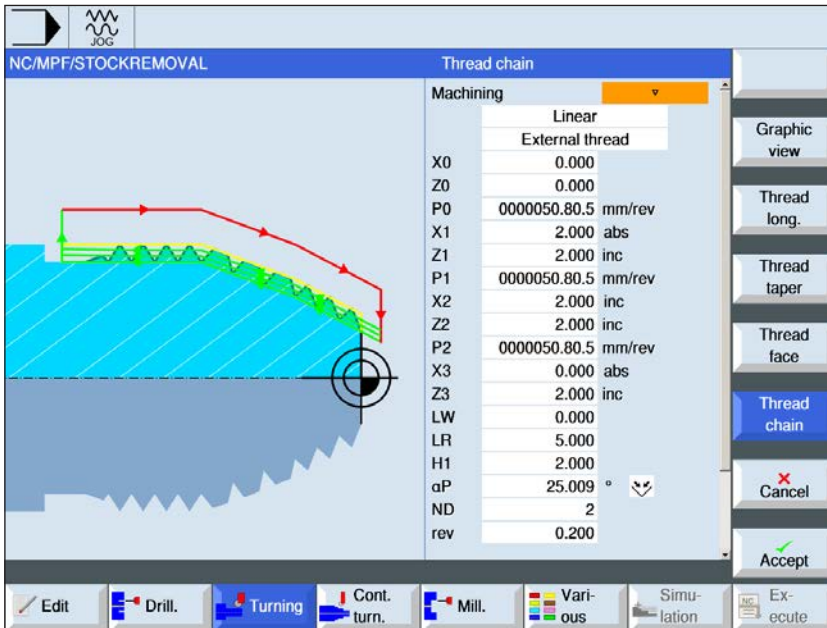

The "Select" button gives you the option to change parameters and/or units. To do this move the cursor to the appropriate field and press button.

Parameter	Description	Unit
Machining	<ul style="list-style-type: none"> ▾ Roughing ▾ ▾ Finishing ▾ + ▾ ▾ ▾ ((Roughing and finishing)) 	
Infeed (only for ▾ and ▾ + ▾ ▾ ▾)	<ul style="list-style-type: none"> Linear: infeed with constant cutting depth Degressive: infeed with constant chip cross-section 	
Thread	Internal thread and external thread	
X0	Reference point X from thread table Ø (absolute, always Ø).	mm
Z0	Reference point Z (absolute)	mm
P0	Thread pitch 1.	mm/rev in/rev Threads/" MODULE
X1 or X1α	<ul style="list-style-type: none"> Intermediate point 1 X Ø (abs) or Intermediate point 1 referred to X0 (incr.) or Oblique thread 1 Incremental dimension: The symbol is analyzed.	mm degrees
Z1	<ul style="list-style-type: none"> Intermediate point 1 Z (abs) or Intermediate point 1 referred to Z0 (incr.) 	
P1	Thread pitch 2 (Unit configured as for P0)	mm/rev in/rev Threads/" MODULE

Parameter	Description	Unit
X2 or X2 α	<ul style="list-style-type: none"> • Intermediate point 2 X \emptyset (abs) or • Intermediate point 2 referred to X1 (incr.) or • Oblique thread 2 (abs or incr.) Incremental dimension: The symbol is analyzed.	mm degrees
Z2	<ul style="list-style-type: none"> • Intermediate point 2 Z (abs) or • Intermediate point 2 referred to Z1 (incr.) 	
P2	Thread pitch 3 (Unit configured as for P0)	mm/rev in/rev Threads/" MODULE
X3	<ul style="list-style-type: none"> • End point X \emptyset (abs) or • End point 3 referred to X2 (incr.) or • Oblique thread 3 	
Z3	<ul style="list-style-type: none"> • End point Z \emptyset (abs) or • End point referred to Z2 (incr.) 	
LW	Thread course	
LR	Thread runout	
H1	Thread depth	
DP or αP	Oblique infeed (edge) or oblique infeed (angle)	
	<ul style="list-style-type: none"> • Infeed along an edge • Infeed with alternating edge 	
D1 or ND	First infeed depth or number of roughing steps - (only for ∇ and $\nabla + \nabla \nabla \nabla$)	
U	Finishing pass in X and Z – (only for ∇ and $\nabla + \nabla \nabla \nabla$)	
NN	Number of empty cuts - (only for $\nabla \nabla \nabla$ and $\nabla + \nabla \nabla \nabla$)	
VR	Reverse distance	
Multi-thread	<ul style="list-style-type: none"> • yes • no 	
$\alpha 0$	Start angle offset	
N	Number of threads The threads are distributed evenly along the rotating part, with the first thread always being placed at 0°.	
DA	Thread change depth (incr.)	

Thread chain cycle description

- 1** Approach the start point calculated in the cycle at the start of the run-in path for the first thread in rapid traverse (G0).
- 2** Infeed for roughing according to the set infeed type.
- 3** The thread cutting step is repeated according to the programmed number of roughing steps.
- 4** In the next cut, the finishing pass is machined with G33.
- 5** This cut is repeated according to the number of empty cuts
- 6** The entire movement process is repeated for each additional thread.



Cutoff (CYCLE92)

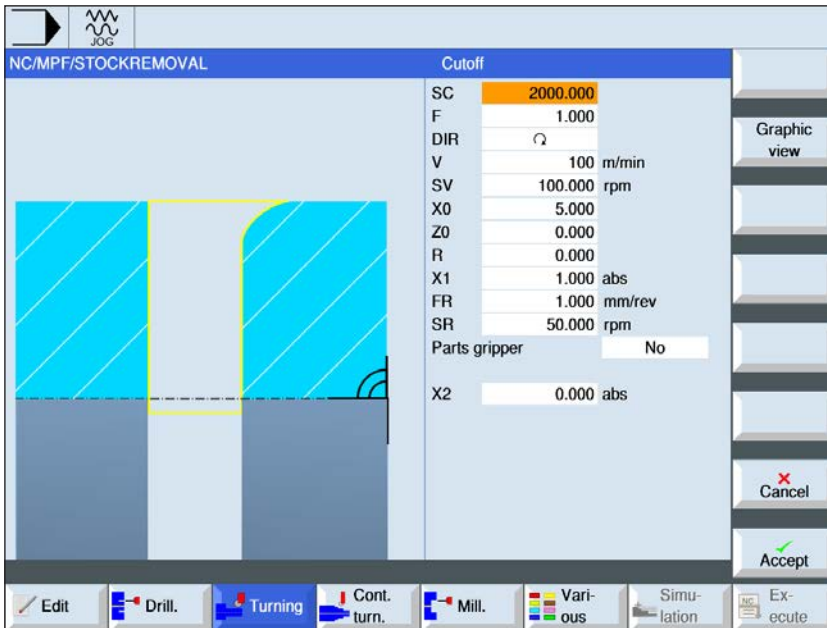

The "Select" button gives you the option to change parameters and/or units. To do this move the cursor to the appropriate field and press button.

Parameter	Description	Unit
SC	Safety distance	mm
F	Feed: the enabled feed type is retained	
S / V	Spindle speed	rpm
DIR	Spindle direction of rotation	
X0	Reference point in X Ø (absolute, always diameter)	mm
Z0	Reference point in Z (absolute)	mm
FS or R	Bevel width or rounding radius	mm
X1	Depth for speed reduction Ø (absolute) or depth for speed reduction relative to X0 (incremental)	mm
FR	reduced feed	in/rev
SR	reduced speed	rpm
Part catcher	<ul style="list-style-type: none"> • yes • no 	
XM	Move out to parts catcher depth in X	mm
X2	Final depth Ø (absolute) or final depth relative to X1 (incremental)	mm

Grooving cycle description

1. The tool moves in rapid traverse only to the startpoint calculated within the cycle.
2. The bevel or radius is finished with the machining feed.
3. The groove is made with machining feed up to depth X1.
4. The feed is continued with reduced feed FR and reduced speed SR to depth X2.
- 5 The tool withdraws to the safety distance in rapid traverse.

If your lathe is fitted appropriately, you can move out a workpiece housing (parts catcher) which accepts the grooved workpiece. The moving out of the workpiece housing must be approved in a machine datum.



Contour turning

- New contour
- Machine (CYCLE952)
- Groove (CYCLE952)
- Rotary groove (CYCLE952)

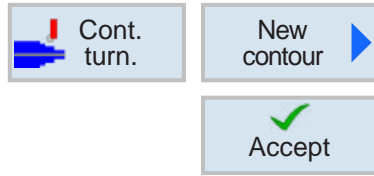

Create new contour

- Enter contour name and confirm with softkey. If the program name exists already, an error machine pops up with a prompt to enter a new name.

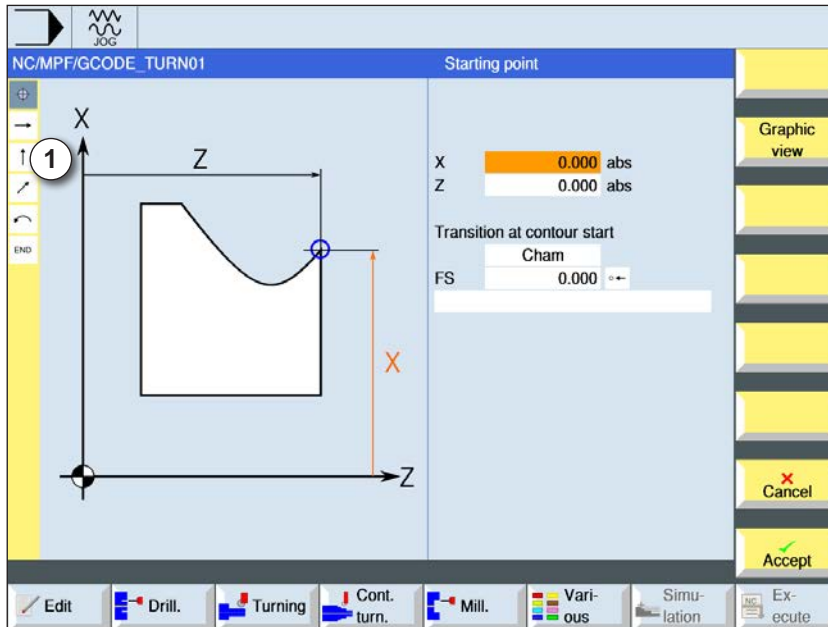

Instructions:
The individual contour elements of a contour will be shown symbolically in the indicated sequence on the left alongside the graphic window (1).

1 Contour element

- Then the start point of the contour will be entered.
- If applicable, enter additional commands in the form of G-Code.
- Press softkey to apply the cycle in the workpiece program.
- Enter individual contour elements and apply with softkey:

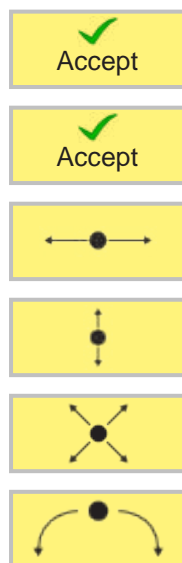

Straight line element in Z

Straight line element in X

Straight line element in ZX

Circular element



Contour element straight line Z

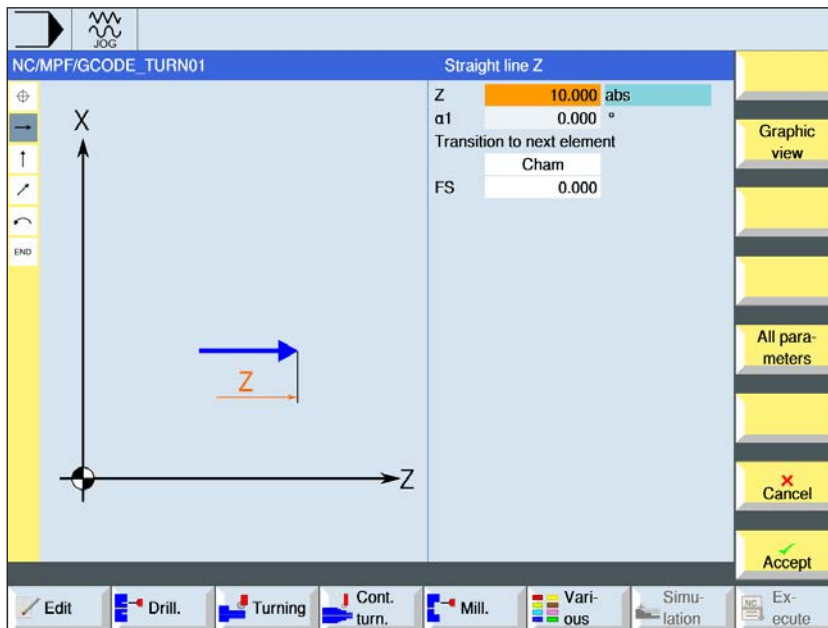

The "Select" button gives you the option to change parameters and/or units. To do this move the cursor to the appropriate field and press button.

Parameter	Description	Unit
Z	End point Z (absolute or incremental)	mm
α_1	Start angle e.g. to Z-axis	degrees
α_2	Angle to previous element	degrees
Transition to succeeding element	Type of transition <ul style="list-style-type: none"> • Radius • Bevel 	
R	Transition to succeeding element - Radius	mm
FS	Transition to succeeding element - Bevel	mm
Additional commands	Additional G-code commands	



Contour element straight line X

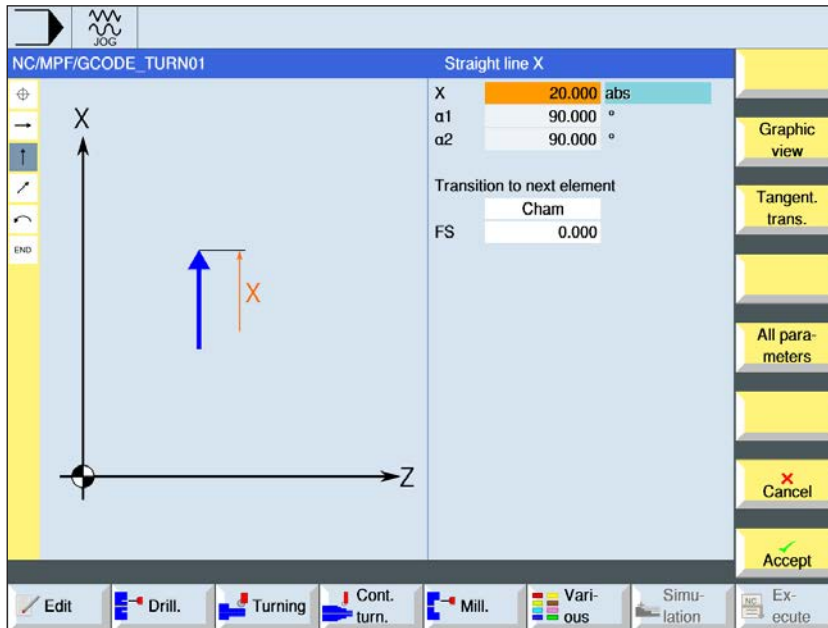

The "Select" button gives you the option to change parameters and/or units. To do this move the cursor to the appropriate field and press button.

Parameter	Description	Unit
X	End point X Ø (absolute) or X (incremental)	mm
$\alpha 1$	Start angle to Z-axis	degrees
$\alpha 2$	Angle to previous element	degrees
Transition to succeeding element	Type of transition • Radius • Bevel	
R	Transition to succeeding element - Radius	mm
FS	Transition to succeeding element - Bevel	mm
Additional commands	Additional G-code commands	



Contour element straight line ZX

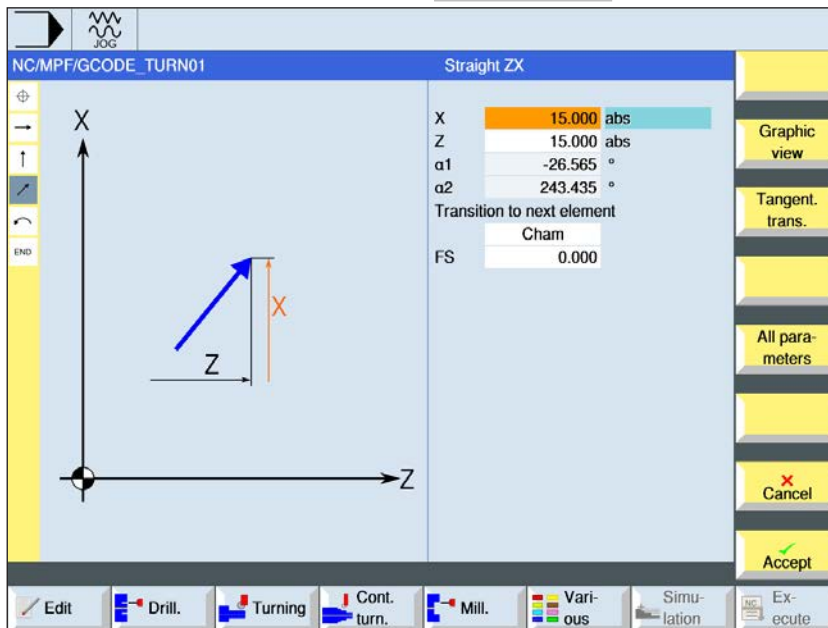

The "Select" button gives you the option to change parameters and/or units. To do this move the cursor to the appropriate field and press button.

Parameter	Description	Unit
X	End point X Ø (absolute) or end point X (incremental)	mm
Z	End point Z (absolute or incremental)	mm
L	Length	mm
α_1	Start angle to Z-axis	degrees
α_2	Angle to previous element	degrees
Transition to succeeding element	Type of transition <ul style="list-style-type: none"> • Radius • Bevel 	
R	Transition to succeeding element - Radius	mm
FS	Transition to succeeding element - Bevel	mm
Additional commands	Additional G-code commands	



Contour element circle

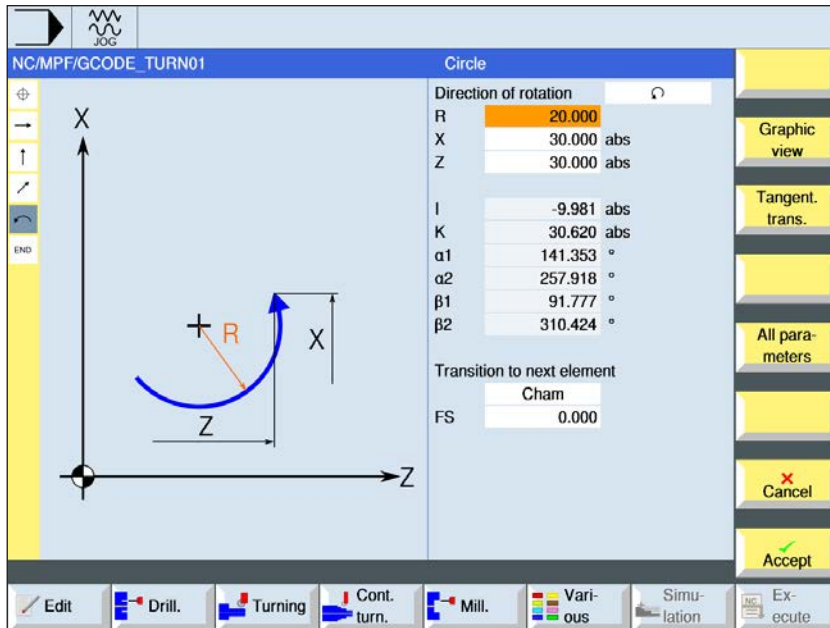

The "Select" button gives you the option to change parameters and/or units. To do this move the cursor to the appropriate field and press button.

Parameter	Description	Unit
Direction of rotation	<ul style="list-style-type: none"> Direction of rotation right Direction of rotation left 	
R	Radius	mm
Z	End point Z (absolute or incremental)	mm
X	End point X Ø (abs) or end point X (incr.)	mm
K	Circle center K (absolute or incremental)	mm
I	Circle center I Ø (absolute or circle center I (incremental))	mm
$\alpha 1$	Start angle to Z-axis	degrees
$\alpha 2$	Angle to previous element	degrees
$\beta 1$	End angle to Z-axis	degrees
$\beta 2$	Opening angle	degrees
Transition to succeeding element	Type of transition <ul style="list-style-type: none"> • Radius • Bevel 	
R	Transition to succeeding element - Radius	mm
FS	Transition to succeeding element - Bevel	mm
Additional commands	Additional G-code commands	

Graphic
view

Other functions:

- Change view
This softkey switches between the graphics window and the input screen.

Tangent.
trans.

- Tangent to previous element
Program the transition to the previous element as a tangent.

Dialog
select

- change dialog concerned
When a dialogue selection has already been made this softkey changes the selected solution again.

All para-
meters

- Show additional parameters
If additional parameters should be shown for individual contour elements, e.g. to enter additional commands.

Close
contour

- Close contour
The contour will be closed from the current position with a straight line to the start point.

Symbol representation of the contour elements:

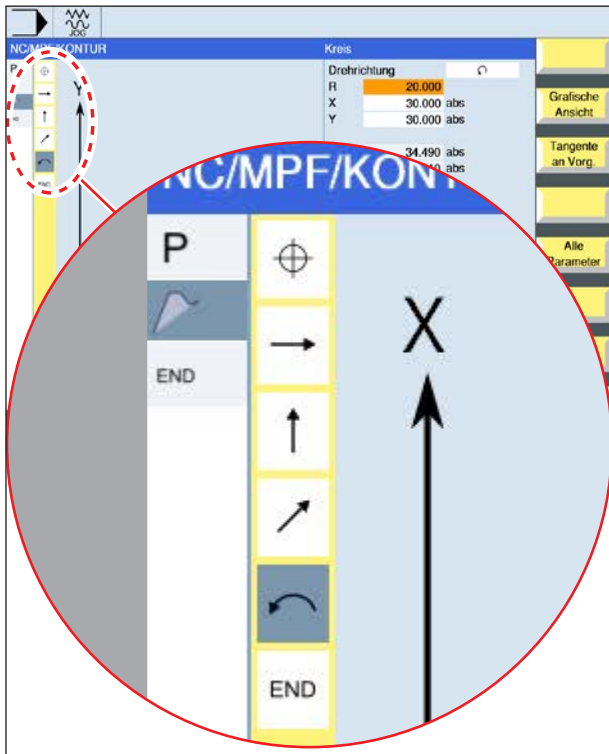

Contour element	Symbol	Meaning
Start point		Start point of the contour
Straight up Straight down		Straight line in 90° grid
Straight left Straight right		Straight line in 90° grid
Straight line anywhere		Straight line with arbitrary pitch
Curve right Curve left		Circle
Contour termination	END	End of the contour description

The contour element can accept different line types and colours:

- Black: Programmed contour
- Orange: Current contour element
- Line-dot-dot: Partially-defined element

The scaling of the coordinate system adapts to the change of the entire contour.

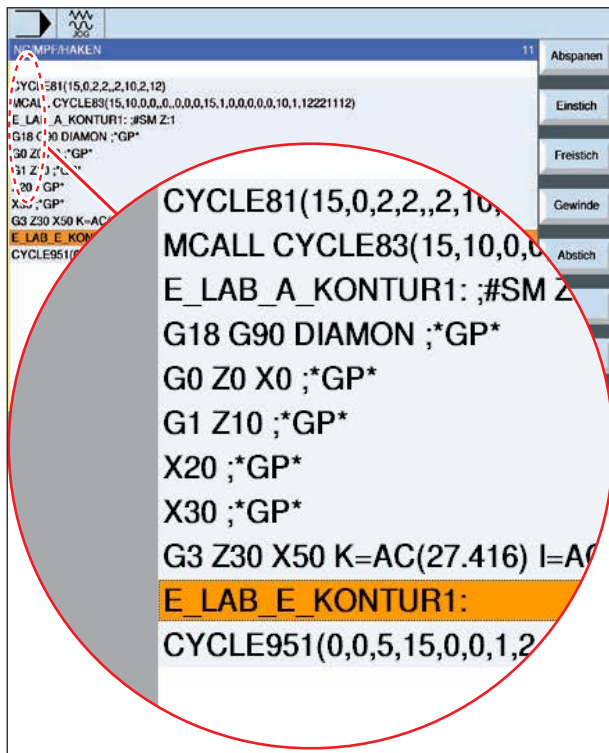

Link representation of contour elements with contour cycles:

A complete contour cycle consists of the associated contour (1) and the machining cycle (2). The programming sequence must be observed: The contour will be created first and the machining cycle afterwards (e.g.: path milling). The control system links both program parts with a symbolic bracket (3) in the cycle list.

Change contour

Change contour element

- Open the program to be processed.
- Use the cursor to select the program block in which the contour should be changed. The individual contour elements will be listed.
- Position cursor at the point to insert or change.
- Use the softkey to select the desired element.
- Enter parameter in the input screen or delete the element and select a new element.
- Press Softkey. The desired contour element will be inserted or changed on the contour.



Change
selection

✓
Accept

Delete contour element

- Open the program to be processed.
- Position cursor on the contour element that should be deleted.
- Press Softkey.
- Press Softkey.

Delete
element

✓
Delete



Machine (CYCLE952)

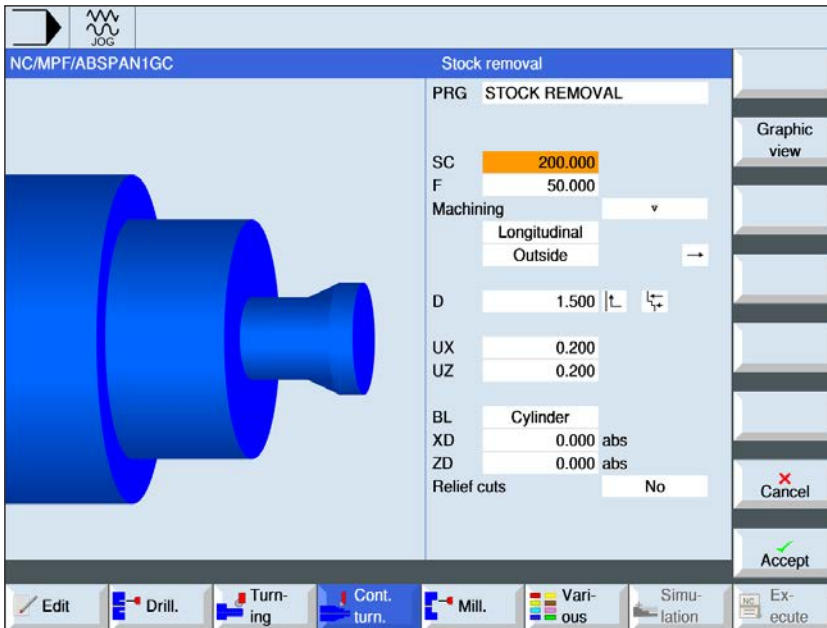



The "Select" button gives you the option to change parameters and/or units. To do this move the cursor to the appropriate field and press button.

Instructions:

In G-code programs, the programs or path information to be generated is stored in the directory in which the main program is found. It should also be noted that existing programs in the directory with the same names as the program to be generated will be overwritten.

Parameter	Description	Unit
PRG	Name of the program to be generated	
SC	Safety distance	mm
F	Feed	mm/min
RP	Retract plane	mm
Machining	<ul style="list-style-type: none"> ▾ Roughing ▾ ▾ ▾ Finishing 	
Machining direction	<ul style="list-style-type: none"> • Longitudinally • Plane 	
Position	<ul style="list-style-type: none"> • internal • external 	

Parameter	Description	Unit
	<ul style="list-style-type: none"> • from internal to external • from external to internal • from front to back side • from back to front side <p>The machining direction is dependent on the machining direction or choice of tool.</p>	
D	maximum infeed depth – (only for ▽)	mm
DX	maximum infeed depth - (only for contour parallel alternatively to D)	mm
UZ	Finishing allowance in Z– (not for finishing)	mm
	<ul style="list-style-type: none"> • Always track at the contour 	
	<ul style="list-style-type: none"> • Cut division even 	
UX or U	Finishing pass in X or finishing pass in X and Z – (only for ▽)	mm
UZ	Finishing pass in Z – (only for UX)	mm
DI	For zero: continuous cut - (only for ▽)	mm
BL	Unmachined part description <ul style="list-style-type: none"> • Cylinder 	
XD	only for unmachined part description cylinder <ul style="list-style-type: none"> • For unmachined part description cylinder Allowance or cylinder dimension Ø (abs) Allowance or cylinder dimension (incr.) 	mm
ZD	only for unmachined part description cylinder <ul style="list-style-type: none"> • For unmachined part description cylinder Allowance or cylinder dimension (absolute or incremental) 	mm
Allowance	Allowance for preliminary finishing - (only for ▽ ▽ ▽) <ul style="list-style-type: none"> • yes U1 contour allowance • no 	
U1	Correction allowance in X and Z directions (incremental) – (only for allowance) <ul style="list-style-type: none"> • positive value: Correction allowance is unchanged • negative value: Correction allowance is also removed for finishing allowance 	mm
Rear cuts	Machine rear cuts <ul style="list-style-type: none"> • yes • no 	mm
FR	Rear cuts entry feed	mm

Tracking the contour

To prevent residual corners remaining when roughing, select "Always track at the contour". This removes the noses that are left with every cut at the end (owing to the cutting geometry) on the contour. The setting "Track as far as the previous cutting point" speeds up the machining of the contour. However, residual corners are not detected and machined. It is therefore essential that you check the pattern before machining using simulation.

Alternating cut depth

So as not to stress the cutting tool constantly, you can also work with alternating cut depth instead of constant cut depth D. This can increase the working life of the tool. The percentage for alternating cut depth is set in a machine datum.

Cut division

If you want to avoid very thin cuts occurring through contour edges with cut division, you can align cut division to the contour edges. With this machining, the contour is then divided by the edges into individual cuts and the cut is divided for each cut separately.

Limit machining area

If you want to machine a given area of the contour with another tool, the machining area can be limited so that only the wanted part of the contour is machined. Between 1 and 4 limit lines can be defined.

Feed interruption

If you want to prevent excessively large chios while machining, a feed interruption can be programmed. The parameter DI gives the path after which the feed should be interrupted.

Name convention

In G-code programs with residual machining, you must ensure that the file name, which includes the updated residual contour, is given without the suffixed characters ("_C" and a two-digit number). In systems with a single channel, the cycles do not apply a name extension to the programs for generation.



Groove (CYCLE952)

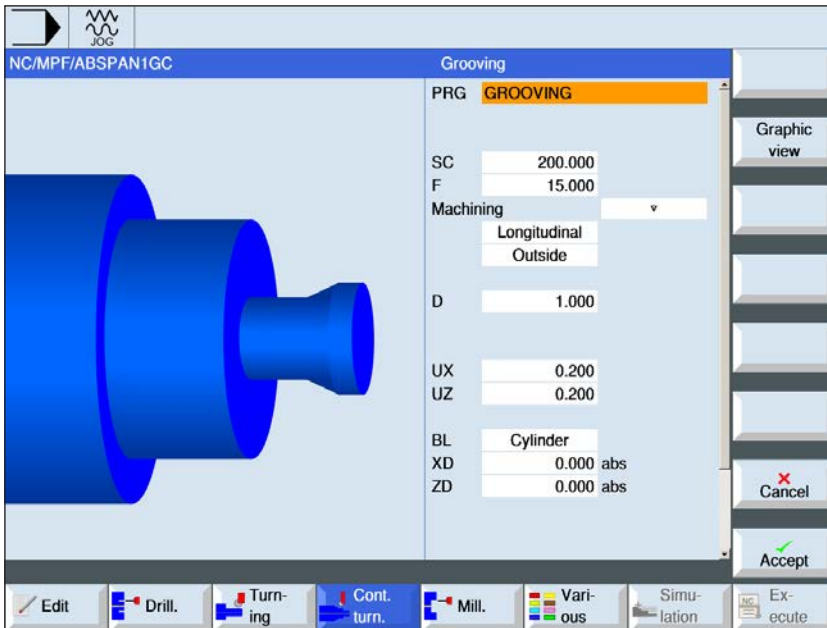

The "Select" button gives you the option to change parameters and/or units. To do this move the cursor to the appropriate field and press button.

Parameter	Description	Unit
PRG	Name of the program to be generated	
SC	Safety distance	mm
F	Feed	mm/min
Machining	<ul style="list-style-type: none"> ▾ Roughing ▾ ▾ Finishing 	
Machining direction	alternating machining direction <ul style="list-style-type: none"> • transverse • longitudinally 	
Position	<ul style="list-style-type: none"> • in front (for transverse machining direction) • behind (for transverse machining direction) • external (for machining direction longitudinally) • internal (for machining direction longitudinally) 	
D	Maximum infeed depth (only for ▾ roughing)	mm
XDA	1. Grooving limit tool (abs) – (only for transverse machining direction)	mm
XDB	2. Grooving limit tool (abs) – (only for transverse machining direction)	mm
UX or U	Finishing pass in X or finishing pass in X and Z – (only for ▾ roughing)	mm
UZ	Finishing pass in Z – (only for UX)	mm

Parameter	Description	Unit
BL	Unmachined part description • Cylinder	
XD	only for unmachined part description cylinder • For unmachined part description cylinder Allowance or cylinder dimension \varnothing (abs) Allowance or cylinder dimension (incr.)	mm
ZD	only for unmachined part description cylinder • For unmachined part description cylinder Allowance or cylinder dimension (absolute or incremental)	mm
Allowance	Pass for preliminary finishing - (only for ▽ ▽ ▽ finishing) • yes U1 contour allowance • no	mm
U1	Correction allowance in X and Z directions (incremental) – (only for allowance)	mm
N	Number of grooves	
DP	Groove spacing (incr.)	mm

Before the groove is programmed, its contour must first be entered.

If the groove is wider than the active tool, the width will be machined in several steps. The tool will also be offset in every groove by a (maximum) 80% of the tool width. When grooving, the cycle takes into account an unmachined part that can be from a cylinder, a pass on the finished part contour or any unmachined part contour.

For more information on grooving, see "Machining" cycle.



Rotary groove (CYCLE952)

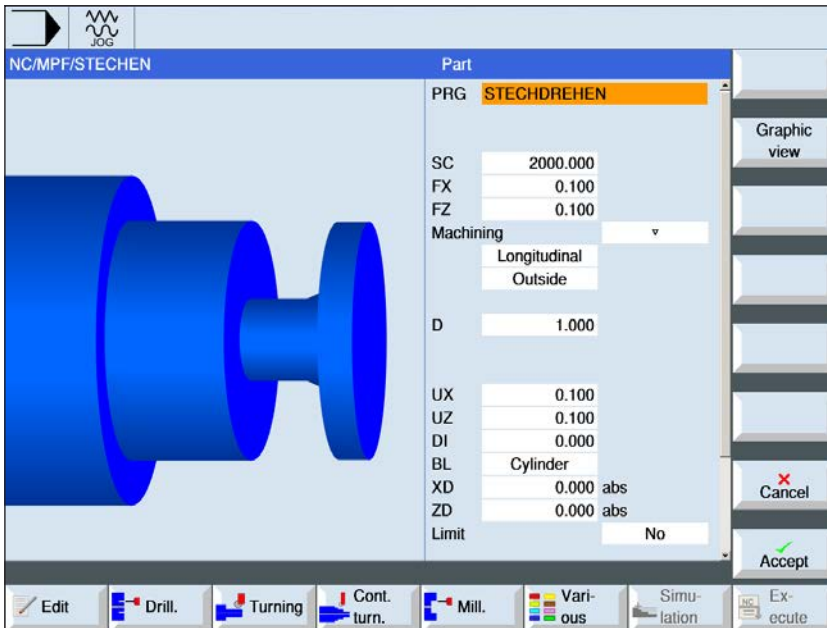

The "Select" button gives you the option to change parameters and/or units. To do this move the cursor to the appropriate field and press button.

Parameter	Description	Unit
PRG	Name of the program to be generated	
SC	Safety distance	mm
FX	Feed in X-direction	mm/min
FZ	Feed in Z-direction	mm/min
Machining	<ul style="list-style-type: none"> ▾ Roughing ▾ ▾ Finishing 	
Machining direction	alternating machining direction <ul style="list-style-type: none"> • transverse • longitudinally 	
Position	<ul style="list-style-type: none"> • in front • behind 	
D	Maximum infeed depth (only for ▾ roughing)	mm
XDA	1. Grooving limit tool (abs) – (only for transverse machining direction)	mm
XDB	2. Grooving limit tool (abs) – (only for transverse machining direction)	mm
UX or U	Finishing pass in X or finishing pass in X and Z – (only for ▾ roughing)	mm
UZ	Finishing pass in Z – (only for UX)	mm

Parameter	Description	Unit
DI	For zero: continuous cut - (only for ▽ roughing)	mm
BL	Unmachined part description <ul style="list-style-type: none"> • Cylinder • Allowance • Contour 	
XD	only for unmachined part description cylinder and allowance <ul style="list-style-type: none"> • For unmachined part description cylinder Allowance or cylinder dimension \varnothing (abs) Allowance or cylinder dimension (incr.) • For unmachined part description allowance Allowance on contour \varnothing (abs) Allowance on the contour (incremental) 	mm
ZD	only for unmachined part description cylinder and allowance <ul style="list-style-type: none"> • For unmachined part description cylinder Allowance or cylinder dimension (absolute or incremental) • For unmachined part description allowance Allowance on the contour (absolute or incremental) 	mm
Allowance	Pass for preliminary finishing - (only for ▽ ▽ ▽ finishing) <ul style="list-style-type: none"> • yes U1 contour allowance • no 	mm
U1	Correction allowance in X and Z directions (incremental) – (only for allowance) <ul style="list-style-type: none"> • positive value: Correction allowance is unchanged • negative value: orrection allowance is also removed for finishing allowance 	mm
Limit	Limit machining area <ul style="list-style-type: none"> • yes XA: 1. XA limit \varnothing XB: 2. XB limit \varnothing (absolute) or 2nd limit relative to XA (incremental) ZA: 1. ZA limit ZB: 2. ZB limit (absolute) or 2nd limit relative to ZA • no 	
N	Number of grooves	
DP	Groove spacing (incr.)	mm

Before the groove is programmed, its contour must first be entered.

If the groove is wider than the active tool, the width will be machined in several steps. The tool will also be offset in every groove by a (maximum) 80% of the tool width.

When grooving, the cycle takes into account an unmachined part that can be from a cylinder, a pass on the finished part contour or any unmachined part contour.

For more information on grooving, see "Machining" cycle.

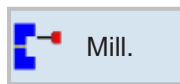

Milling

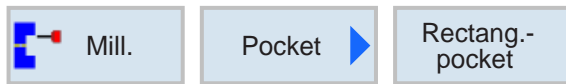

- Pocket (POCKET3, POCKET4)
- Spigot (CYCLE76, CYCLE77)
- Slot (SLOT1, SLOT2, CYCLE899)
- Thread milling (CYCLE70)
- Engraving (CYCLE60)

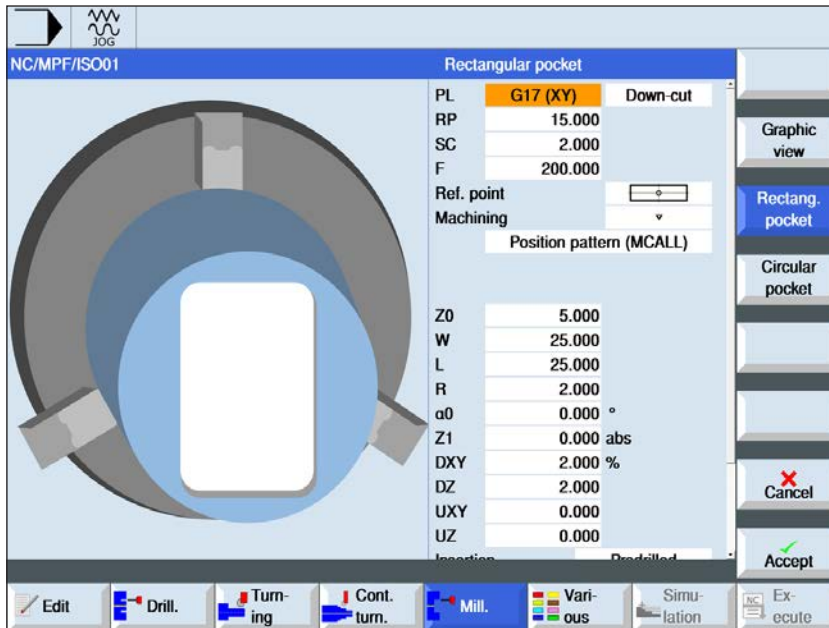

Elbow pocket (POCKET3)

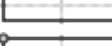
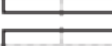
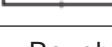

The "Select" button gives you the option to change parameters and/or units. To do this move the cursor to the appropriate field and press button.

Parameter	Description	Unit
PL	Machining plane: <ul style="list-style-type: none"> • G17 (XY) • G19 (YZ) if nothing is selected, the status of the last setting applies	
RP	Retract plane	mm
SC	Safety distance	mm
F	Feed	mm/min
Milling direction	<ul style="list-style-type: none"> • Up cut • Downcut 	
Reference point	<ul style="list-style-type: none"> •  (center) •  (bottom left) •  (bottom right) •  (top left) •  (top right) 	
Machining	<ul style="list-style-type: none"> • ▾ Roughing • ▾ ▾ Finishing • ▾ ▾ ▾ Edge finishing • Chamfering 	
Machining position	<ul style="list-style-type: none"> • Position template Mill rectangular pocket at the programmed position (X0, Y0, Z0). • Individual position Position with MCALL 	

Parameter	Description	Unit
X0 Y0 Z0	The positions are relative to the reference point: (only for "single position") Reference point in X, Y and Z	mm
W	Width of the pocket	mm
L	Length of the pocket	mm
R	Corner radius	mm
$\alpha 0$	Angle	degrees
Z1 X1	Depth relative to Z0 (incremental) or pocket depth (absolute) (only if ▽, ▽ ▽ ▽ or ▽ ▽ ▽ Edge)	mm
DX DYZ	<ul style="list-style-type: none"> • maximum plane infeed • Plane infeed %, as a proportion of the plane infeed (mm) to the mill diameter (mm); (only if ▽ or ▽ ▽ ▽) 	mm %
DZ DX	maximum depth infeed (only with roughing); (only if ▽, ▽ ▽ ▽ or ▽ ▽ ▽ Edge)	mm
UX UYZ	Finishing pass plane (only if ▽, ▽ ▽ ▽ or ▽ ▽ ▽ edge)	mm
UZ UX	Finishing pass depth; (only if ▽ or ▽ ▽ ▽)	mm
Plunge mode	<p>(only if ▽, ▽ ▽ ▽ or ▽ ▽ ▽ edge)</p> <ul style="list-style-type: none"> • pre-drilled: With G0 the pocket center, approach at retraction plane height and also approach this position with G0 at the reference point brought forward by the safety distance. The elbow pocket is machined with the selected plunge strategy, taking account of the programmed unmachined dimensions. • vertical: Plunge vertically on pocket center The calculated current infeed depth will be executed in the pocket center in one block. The milling cutting tool must cut via the center or it must be pre-drilled. • helical: Plunging on spiral path The center of the milling cutter moves on the spiral path defined by the radius and the depth per revolution (helical path). Once the depth for the infeed has been reached, another full circle will be executed, in order to overcome the angular path of the plunge. • swinging: Plunge swinging on center axis of the rectangular pocket axis The center of the mill swings on a straight line back and forth till the infeed depth is reached. Once the depth has been reached, the path will be executed again without the infeed, in order to overcome the angular path of the plunge. 	

Parameter	Description	Unit
FZ FX	Infeed depth (only when vertical)	mm/min mm/tooth
EP	Maximum pitch of the helix (only with helical plunging)	mm/rev
ER	Radius of the helix (only with helical plunging) The radius may not be larger than the milling cutting tool radius, as otherwise material remains.	mm
EW	Maximum plunge angle (only with swinging plunging)	degrees
Clearing	(only for roughing) <ul style="list-style-type: none"> • Complete machining The right corner pocket will be milled from the complete material. • Re-working A smaller right corner pocket or a drill hole is already available. This can be enlarged in one or more axes. Then the parameters AZ, W1 and L1 must be programmed. 	
AZ AX	Depth of the pre-machining (only when re-working)	mm
W1	Width of the pre-machining (only when re-working)	mm
L1	Length of the pre-machining (only when re-working)	mm
FS	Bevel width for chamfering - (only for chamfering)	mm
ZFS XFS	Tool tip plunge depth (absolute or incremental) (only for chamfering)	mm

Cycle description

- 1** The control system positions the tool in rapid traverse (G0) at the retract plane height on the elbow pocket center point and at the safety distance.
- 2** The tool mills into the material according to the selected strategy.
- 3a** Machining ▾ Roughing
During roughing the machining will be from the center out of the individual planes of the elbow pocket until the depth Z1 is reached.
- 3b** Machining ▾ ▾ Finishing
During finishing the edge will always be processed first. In the process the rectangular pocket edge will be approached in the quarter circle in which it joins the corner radius. In the last infeed the bottom will be finished from the center.
- 3c** Machining ▾ ▾ Edge finishing
Edge finishing takes place as with finishing. Only the last infeed (bottom finishing) is absent.
- 3d** Machining chamfering
During chamfering the edge on the top of the rectangular pocket will be breached.
- 4** The elbow pocket is always machined from inwards to outwards with the selected machining type.
- 5** The tool moves back to the safety distance in rapid traverse (G0).

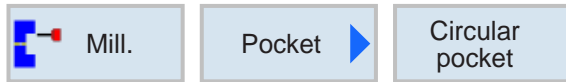

Circular pocket (POCKET4)

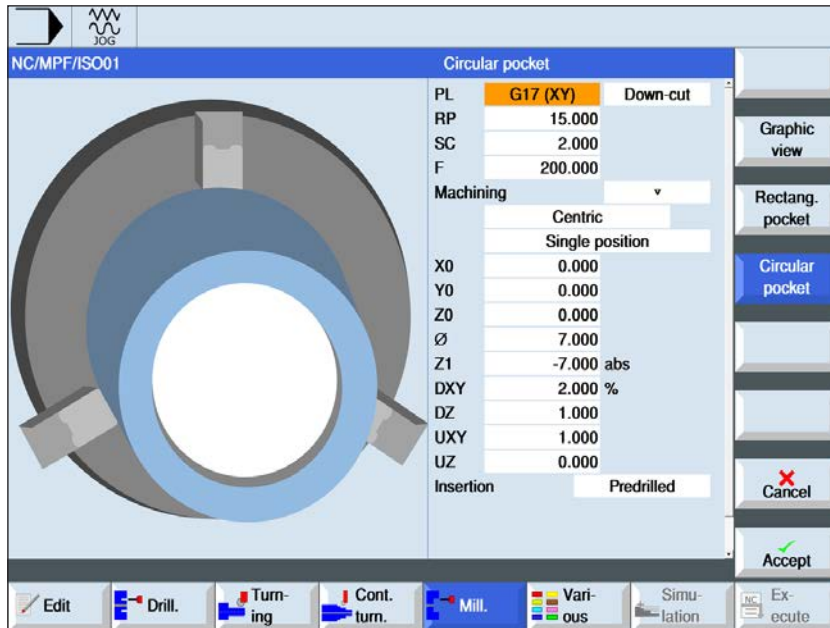

The "Select" button gives you the option to change parameters and/or units. To do this move the cursor to the appropriate field and press button.

Parameter	Description	Unit
PL	Machining plane: <ul style="list-style-type: none"> • G17 (XY) • G19 (YZ) if nothing is selected, the status of the last setting applies	
RP	Retract plane	mm
SC	Safety distance	mm
F	Feed	mm/min
Milling direction	<ul style="list-style-type: none"> • Up-cut milling • Down-cut milling 	
Machining	<ul style="list-style-type: none"> • ▾ Roughing • ▾ ▾ Finishing • ▾ ▾ ▾ Edge finishing • Chamfering 	
Machining type	<ul style="list-style-type: none"> • planar Planar machining of circular pocket • helical Helical machining of circular pocket 	
Machining position	<ul style="list-style-type: none"> • Individual position A circular pocket will be milled at the programmed position (X0, Y0, Z0). • Position template Several circular pockets will be milled on a position template (e.g. full circle, partial circle, grid, etc.). 	
X0 Y0 Z0	The positions are relative to the reference point = center point of the circular pocket: (only for "single position") Reference point in X, Y and Z	mm

Parameter	Description	Unit
∅	Diameter of the pocket	mm
Z1 X1	Pocket depth (absolute) or depth related to Z0 (incremental) (only if ▽, ▽ ▽ ▽ or ▽ ▽ ▽ edge)	mm
DXY DYZ	<ul style="list-style-type: none"> • maximum plane infeed • maximum plane infeed as a percentage of the mill diameter (only if ▽ or ▽ ▽ ▽) 	mm %
DZ DX	Maximum depth infeed (only if ▽, ▽ ▽ ▽ or ▽ ▽ ▽ edge)	mm
UXY UYZ	Finishing pass plane (only if ▽, ▽ ▽ ▽ or ▽ ▽ ▽ edge)	mm
UZ UX	Finishing pass depth; (only if ▽ or ▽ ▽ ▽)	mm
Plunging	<p>(only if "planar", ▽ or ▽ ▽ ▽)</p> <ul style="list-style-type: none"> • pre-drilled • vertical: Plunge vertically on pocket center The calculated infeed depth will be executed vertically in the pocket center. Feed: Infeed as programmed under FZ. When plunging vertically on the pocket center the milling cutting tool must cut via the center or it must be pre-drilled. • helical: Plunging on spiral path The center of the mill moves with the machining feed on the spiral path defined by the radius and the depth per revolution (helical path). Once the depth for the infeed has been reached, another full circle will be executed, in order to overcome the angular path of the plunge. 	
FZ FX	Infeed depth (only with vertical plunging)	mm/min mm/tooth
EP	Maximum pitch of the helix (only with helical plunging) The pitch of the helix can be less, based on the geometric relationships.	mm/rev
ER	Radius of the helix (only with helical plunging) The radius may not be larger than the milling cutting tool radius, as otherwise material remains.	mm
Clearing	<ul style="list-style-type: none"> • Complete machining The circular pocket should be milled from the whole material (e.g. cast part). • Re-working If a circular pocket or a drill hole already exists, it will be enlarged. The parameters AZ, and ∅1 must be programmed. 	
FS	Bevel width for chamfering (only for chamfering)	mm
ZFS XFS	Tool tip plunge depth (absolute or incremental) - (only for chamfering)	mm
AZ AX	Depth of the pre-machining (only when re-working)	mm
∅1	Diameter of the pre-machining (only when re-working)	mm

Cycle description**Planar plunge mode**

- 1 The control system positions the tool in rapid traverse (G0) at the retract plane height on the rectangular pocket center point and at the safety distance.
- 2 The tool mills into the material according to the selected strategy.
- 3a Machining ▾ Roughing
During roughing the machining will be from the center out of the individual planes of the circular pocket until the depth Z1 is reached.
- 3b Machining ▾ ▾ Finishing
During finishing the edge will always be processed first. In the process the pocket edge will be approached in the quarter circle in which it joins the corner radius. In the last infeed the bottom will be finished from the center.
- 3c Machining ▾ ▾ Edge finishing
Edge finishing is performed like the finishing. The last infeed (bottom finishing) is not applicable.
- 4 The circular pocket is always machined from inwards to outwards with the selected machining type. The material will be cleared away ("by plane").
- 5 The tool moves back to the safety distance in rapid traverse (G0).

Cycle description**Helical plunge mode**

- 1 The control system positions the tool in rapid traverse (G0) at the retract plane height on the rectangular pocket center point and at the safety distance.
- 2 The tool feeds in to the first machining diameter and mills into the material according to the selected strategy.
- 3a Machining ▾ Roughing
During roughing the circular pocket will be processed with top-down helical movements. A full circle will be executed at the pocket depth to remove the remaining material. The tool will be moved freely from the pocket edge and bottom in the quadrant and pulled back to the safety distance in rapid traverse. This sequence repeats in a shell-like way from inside to outside, until the circular pocket is fully processed.
- 3b Machining ▾ ▾ Finishing
When finishing the edge will be processed first with a helical movement to the bottom. A full circle will be executed at the pocket depth to remove the remaining material. The bottom will be milled out in a spiral shape from outside to inside. From the pocket centre there will be a pull-back in rapid traverse to the safety distance.
- 3c Machining ▾ ▾ Edge finishing
When finishing the edge will be processed first with a helical movement to the bottom. A full circle will be executed at the pocket depth to remove the remaining material. The tool will be moved freely from the pocket edge and bottom in the quadrant and pulled back to the safety distance in rapid traverse.
- 4 The circular pocket is machined with the selected machining type to the pocket depth or to the pocket depth with finishing pass.
- 5 The tool moves back to the safety distance in rapid traverse (G0).



Elbow spigot (CYCLE76)

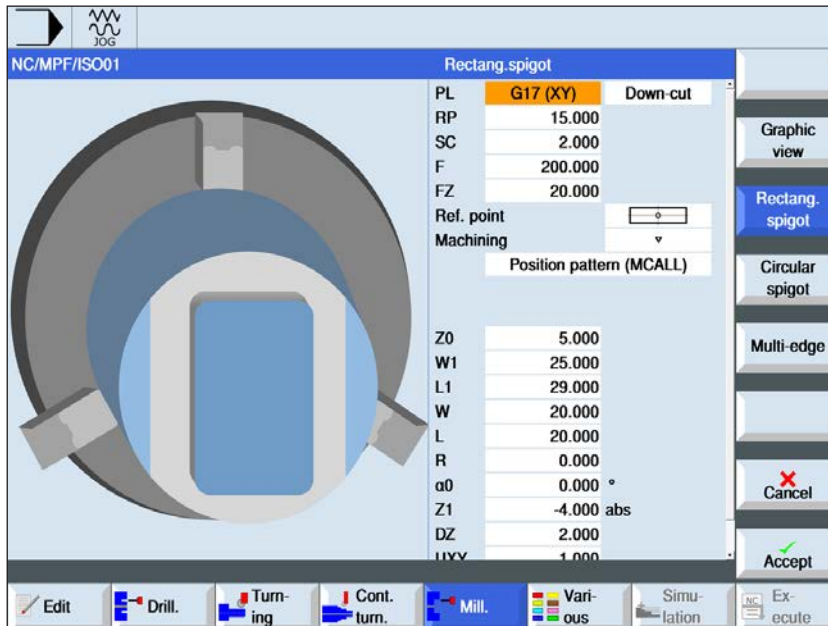

The "Select" button gives you the option to change parameters and/or units. To do this move the cursor to the appropriate field and press button.

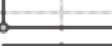
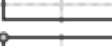
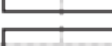
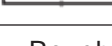
Parameter	Description	Unit
PL	Machining plane: <ul style="list-style-type: none"> • G17 (XY) • G19 (YZ) if nothing is selected, the status of the last setting applies	
RP	Retract plane	mm
Milling direction	<ul style="list-style-type: none"> • Up-cut milling • Down-cut milling 	
SC	Safety distance	mm
F	Feed	mm/min
FZ FX	Infeed depth	mm/min
Reference point	<ul style="list-style-type: none"> •  (center) •  (bottom left) •  (bottom right) •  (top left) •  (top right) 	
Machining	<ul style="list-style-type: none"> • ▾ Roughing • ▾ ▾ Finishing • Chamfering 	
Machining position	<ul style="list-style-type: none"> • Individual position Mill rectangular pocket at the programmed position (X0, Y0, Z0). • Position template Mill rectangular spigot on a position template. • Position with MCALL 	

Parameter	Description	Unit
X0 Y0 Z0	The positions are relative to the reference point: (only for "single position") Reference point in X, Y and Z	mm
W	Spigot width	mm
L	Spigot length	mm
R	Corner radius	mm
$\alpha 0$	Angle	degrees
Z1 X1	Spigot depth (absolute) or depth relative to Z0 (incremental) (only if ▽ or ▽ ▽ ▽)	mm
DZ DX	maximum infeed depth (only if ▽ or ▽ ▽ ▽)	mm
UXY UYZ	Finishing pass plane at the length (L) of the elbow spigot and the width (W) of the elbow spigot. Smaller elbow spigot dimensions will be achieved by calling the cycle again and programming it with reduced finishing pass. (only if ▽ or ▽ ▽ ▽)	mm
UZ UX	Finishing pass depth; (only if ▽ or ▽ ▽ ▽)	mm
W1	Width of the unmachined part of the spigot; Important for determining the approach position (only if ▽ or ▽ ▽ ▽)	mm
L1	Length of the unmachined spigot. Important for determining the approach position (only if ▽ or ▽ ▽ ▽)	mm
FS	Bevel width for chamfering (only for chamfering)	mm
ZFS XFS	Tool tip plunge depth (absolute or incremental) (only for chamfering)	mm

Cycle description

- 1 The control system positions the tool in rapid traverse (G0) at the retract plane height and at the safety distance. The start point lies on the positive X-axis rotated by $\alpha 0$.
- 2 The tool approaches the spigot contour in the semi-circle with machining feed. First the in-feed to the machining depth takes place, then the movement in the plane. The rectangular spigot will be machined in the clockwise or counter-clockwise direction according to the programmed direction of rotation for machining (up-cut milling/down-cut milling).
- 3a Machining ▽ Roughing
When roughing the rectangular spigot will be bypassed, until the programmed finishing pass is reached.
- 3b Machining ▽ ▽ ▽ Finishing
During finishing the rectangular spigot will be bypassed, until depth Z1 is reached.
- 3c Machining - chamfering
During chamfering the edge on the top of the elbow spigot will be breached.
- 4 Once the elbow spigot has been bypassed once, the tool leaves the contour in the semi-circle and the infeed to the next machining plane takes place.
- 5 The elbow spigot will again be approached in the semi-circle and bypassed once. This will be repeated until the programmed spigot depth is reached.
- 6 The tool moves back to the safety distance in rapid traverse (G0).



Circular spigot (CYCLE77)

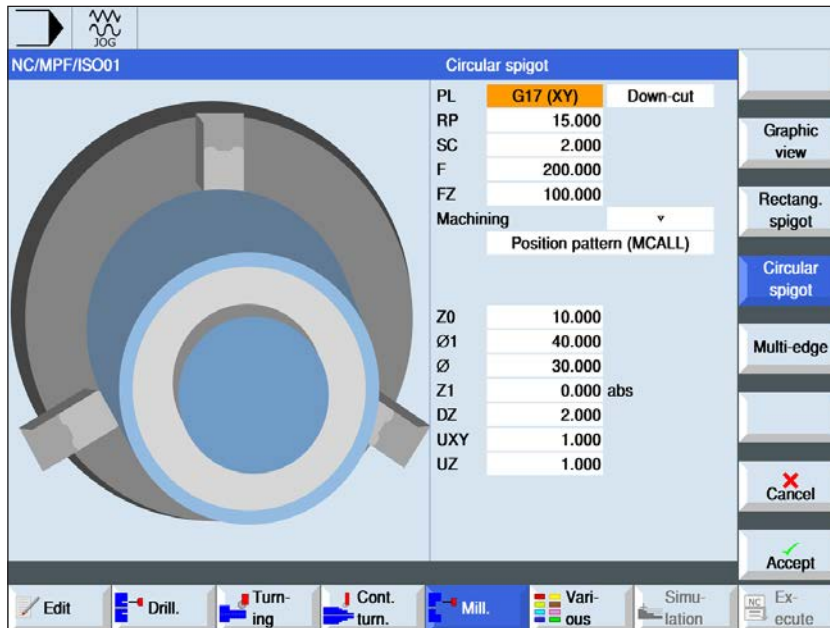

The "Select" button gives you the option to change parameters and/or units. To do this move the cursor to the appropriate field and press button.

Parameter	Description	Unit
PL	Machining plane: <ul style="list-style-type: none"> • G17 (XY) • G19 (YZ) if nothing is selected, the status of the last setting applies	
RP	Retract plane	mm
Milling direction	<ul style="list-style-type: none"> • Up-cut milling • Down-cut milling 	
SC	Safety distance	mm
F	Feed	mm/min
FZ FX	Infeed depth	mm/min
Machining	<ul style="list-style-type: none"> • ▾ Roughing • ▾ ▾ Finishing • Chamfering 	
Machining position	<ul style="list-style-type: none"> • Individual position Mill circular spigot at the programmed position (X0, Y0, Z0). • Position template Mill circular spigot on a position template. Position with MCALL 	
X0 Y0 Z0	The positions are relative to the reference point: (only for "single position") Reference point in X, Y and Z	mm
Ø	Spigot diameter	mm
Z1 X1	Spigot depth (absolute) or depth relative to Z0 (incremental) (only if ▾ or ▾ ▾ ▾)	mm

Parameter	Description	Unit
DZ DX	maximum infeed depth (only if ▽ or ▽ ▽ ▽)	mm
UXY UYZ	Finishing pass plane at the length (L) of the circular spigot and the width (W) of the circular spigot. Smaller circular spigot dimensions will be achieved by calling the cycle again and programming it with reduced finishing pass. (only if ▽ or ▽ ▽ ▽)	mm
UZ UX	Finishing pass depth; (only if ▽ or ▽ ▽ ▽)	mm
∅1	Diameter of the unmachined part of the spigot (Important for determining the approach position)	mm
FS	Bevel width for chamfering (only for chamfering)	mm
ZFS XFS	Tool tip plunge depth (absolute or incremental) (only if chamfering)	mm

Cycle description

1 The control system positions the tool in rapid traverse (G0) at the retract plane height and at the safety distance. The start point is always on the positive X-axis.

2 The tool approaches the spigot contour in the semi-circle with machining feed. First the infeed to the machining depth takes place, then the movement in the plane. The circular spigot will be machined in the clockwise or counter-clockwise direction according to the programmed direction of rotation for machining (up-cut milling/down-cut milling).

3a Machining ▽ Roughing

When roughing the rectangular spigot will be bypassed, until the programmed finishing pass is reached.

3b Machining ▽ ▽ ▽ Finishing

During finishing the rectangular spigot will be bypassed, until depth Z1 is reached.

3c Machining - chamfering

During chamfering the edge on the top of the rectangular spigot will be breached.

4 Once the circular spigot has been bypassed once, the tool leaves the contour in the semi-circle and the infeed to the next machining plane takes place.

5 The circular spigot will again be approached in the semi-circle and bypassed once. This will be repeated until the programmed spigot depth is reached.

6 The tool moves back to the safety distance in rapid traverse (G0).



Multiple edge (CYCLE79)



The "Select" button gives you the option to change parameters and/or units. To do this move the cursor to the appropriate field and press button.

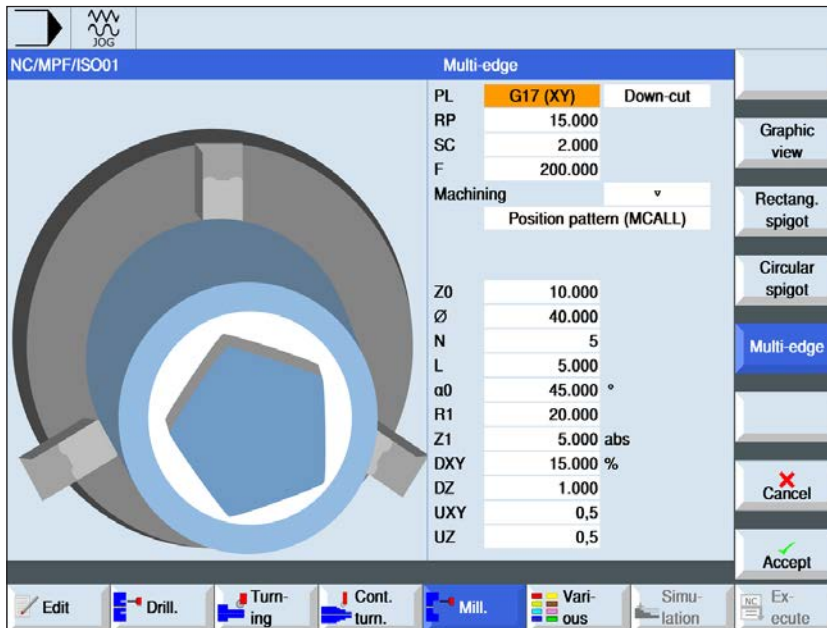

Parameter	Description	Unit
PL	Machining plane: <ul style="list-style-type: none"> • G17 (XY) • G19 (YZ) if nothing is selected, the status of the last setting applies	
RP	Retract plane	mm
Milling direction	<ul style="list-style-type: none"> • Up-cut milling • Down-cut milling 	
SC	Safety distance	mm
F	Feed	mm/min
Machining	<ul style="list-style-type: none"> • ▾ Roughing • ▾ ▾ Finishing • ▾ ▾ ▾ Edge • Chamfering 	
Machining position	<ul style="list-style-type: none"> • Individual position Mill multiple edge at the programmed position (X0, Y0, Z0). • Position template Mill multiple edge on a position template. Position with MCALL 	
X0 Y0 Z0	The positions are relative to the reference point: (only for "single position") Reference point in X, Y and Z	mm
Ø	Diameter of the unmachined part of the spigot	mm
N	Number of edges	

Parameter	Description	Unit
Key width or edge length	Key width or edge length Key width only if N = 1 or an exact number	mm
$\alpha 0$	Angle	degrees
R1 or FS1	Rounding radius or bevel width	
Z1	Groove depth (absolute) or depth relative to Z0 (incremental) (only if ∇ , $\nabla \nabla \nabla$, or $\nabla \nabla \nabla$ edge)	mm
DXY DYZ	<ul style="list-style-type: none"> • maximum plane infeed • maximum level infeed as a percentage of the mill diameter (only if ∇ or $\nabla \nabla \nabla$) 	mm %
DZ DX	maximum infeed depth (only if ∇ or $\nabla \nabla \nabla$)	mm
UXY UYZ	Finishing pass plane (only if ∇ , $\nabla \nabla \nabla$ or $\nabla \nabla \nabla$ edge)	mm
UZ UX	Finishing pass depth; (only if ∇ or $\nabla \nabla \nabla$)	mm
FS	Bevel width for chamfering (only for chamfering)	mm
ZFS XFS	Tool tip plunging depth absolute or incremental (only for chamfering)	mm

Cycle description

- 1 The control system positions the tool in rapid traverse (G0) at the retract plane height and at the safety distance.
- 2 The tool approaches to the multiple edge in the quadrant at machining speed. First the infeed to the machining depth takes place, then the movement in the plane. The multiple edge will be processed in the clockwise or counter-clockwise direction according to the programmed direction of rotation for machining (up-cut milling/down-cut milling).
- 4 Once the first plane has been machined, the tool leaves the contour in the quadrant and the infeed to the next machining plane takes place. Ein Mehrkant mit mehr als zwei Kanten wird spiralförmig umfahren, bei einem Ein- und Zweikant wird jede Kante einzeln bearbeitet.
- 5 The multiple edge is again approached in the quadrant. This will be repeated until the programmed multiple edge depth is reached.
- 6 The tool moves back to the safety distance in rapid traverse (G0).

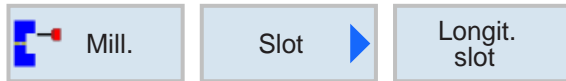

Longitudinal slot (SLOT1)

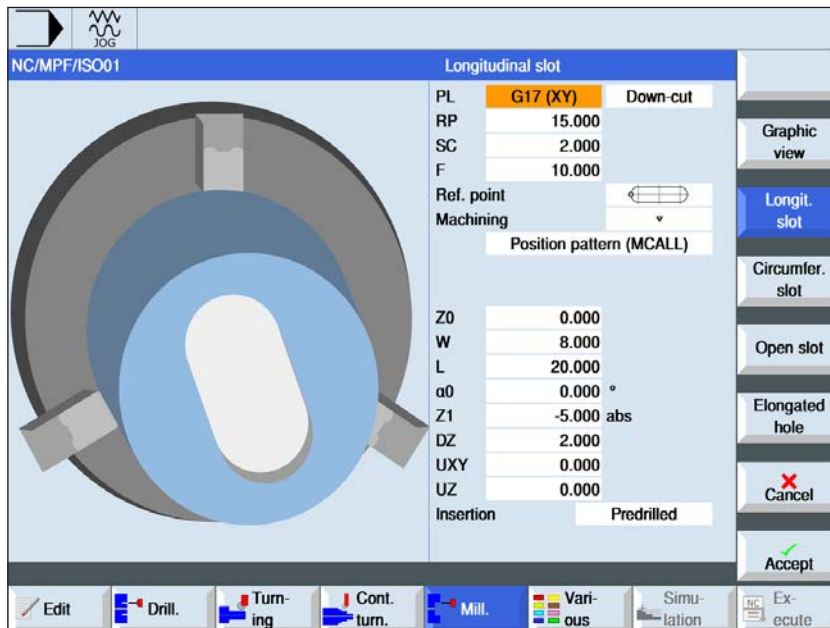

The "Select" button gives you the option to change parameters and/or units. To do this move the cursor to the appropriate field and press button.

Parameter	Description	Unit
PL	Machining plane: <ul style="list-style-type: none"> • G17 (XY) • G19 (YZ) if nothing is selected, the status of the last setting applies	
RP	Retract plane	mm
Milling direction	<ul style="list-style-type: none"> • Up-cut milling • Down-cut milling 	
SC	Safety distance	mm
F	Feed	mm/min
Reference point	<ul style="list-style-type: none"> • (left edge) • (inside left) • (center) • (inside right) • (right edge) 	
Machining	<ul style="list-style-type: none"> • ▾ Roughing • ▾ ▾ Finishing • ▾ ▾ ▾ Edge finishing • Chamfering 	
Machining position	<ul style="list-style-type: none"> • Individual position Mill groove at the programmed position (X0, Y0, Z0). • Position template Mill several grooves at the programmed position template (e.g. partial circle, grid, line). 	

Parameter	Description	Unit
X0 Y0 Z0	The positions are relative to the reference point: (only for "single position") Reference point in X, Y and Z	mm
W	Width of the slot	mm
L	Length of the slot	mm
$\alpha 0$	Angle	degrees
Z1 X1	Slot depth (absolute) or depth relative to Z0 (incremental) (only if ▽, ▽ ▽ ▽, or ▽ ▽ ▽ edge)	mm
DZ DX	Maximum infeed depth (only if ▽, ▽ ▽ ▽, or ▽ ▽ ▽ edge)	mm
UXY UYZ	Finishing pass plane at the length (L) of the slot and the width (W) of the slot. (only if ▽, ▽ ▽ ▽, or ▽ ▽ ▽ edge)	mm
UZ UX	Finishing pass depth; (only if ▽ or ▽ ▽ ▽)	mm
Plunging	(only if ▽ or ▽ ▽ ▽) <ul style="list-style-type: none"> • pre-drilled: Approach the reference point brought forward by the safety distance with G0. • vertical: Plunge vertically on longitudinal slot center: It will be moved to the center of the pocket at the infeed depth. With this setting the milling cutting tool must cut via the center. • helical: Plunging on spiral path: The center of the milling cutter moves on the spiral path defined by the radius and the depth per revolution (helical path). Once the depth for the infeed has been reached, another full longitudinal groove will be executed, in order to overcome the angular path of the plunge. • swinging: Plunge swinging on the center axis of the longitudinal groove: The center of the milling cutter swings on a straight line back and forth till it reaches the depth infeed. Once the depth has been reached, the path will be executed again without the depth infeed, in order to overcome the angular path of the plunge. 	
FZ FX	Infeed depth (only with vertical plunging)	mm/min
EP	Helix pitch	mm/rev
ER	Radius of the helix	mm
EW	Maximum plunge angle (only with swinging plunging)	degrees
FS	Bevel width for chamfering (only for chamfering)	mm
ZFS XFS	Tool tip plunge depth (only when chamfering)	mm

Cycle description

- 1** The control system positions the tool in rapid traverse (G0) at the retract plane height and at the safety distance. The start point lies on the positive X-axis rotated by $\alpha 0$.
- 2** The tool mills into the material according to the selected strategy.
- 3** The longitudinal groove is always machined with the selected machining type from inside to outside.
 - 3a** Machining ▽ Roughing
During roughing the machining will be from the centre out of the individual planes of the groove until the depth Z1 is reached.
 - 3b** Machining ▽ ▽ Finishing
During finishing the edge will always be processed first. In the process the slot edge will be approached in the quarter circle in which it joins the corner radius. In the last infeed the bottom will be finished from the center.
 - 3c** Machining ▽ ▽ Edge finishing
Edge finishing takes place as with finishing. Only the last infeed (bottom finishing) is absent.
 - 3d** Machining - chamfering
During chamfering the edge on the top of the longitudinal slot will be breached.
- 4** The tool moves back to the safety distance in rapid traverse (G0).

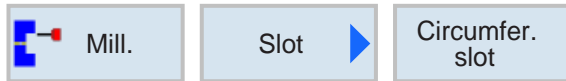

Circular slot (SLOT2)

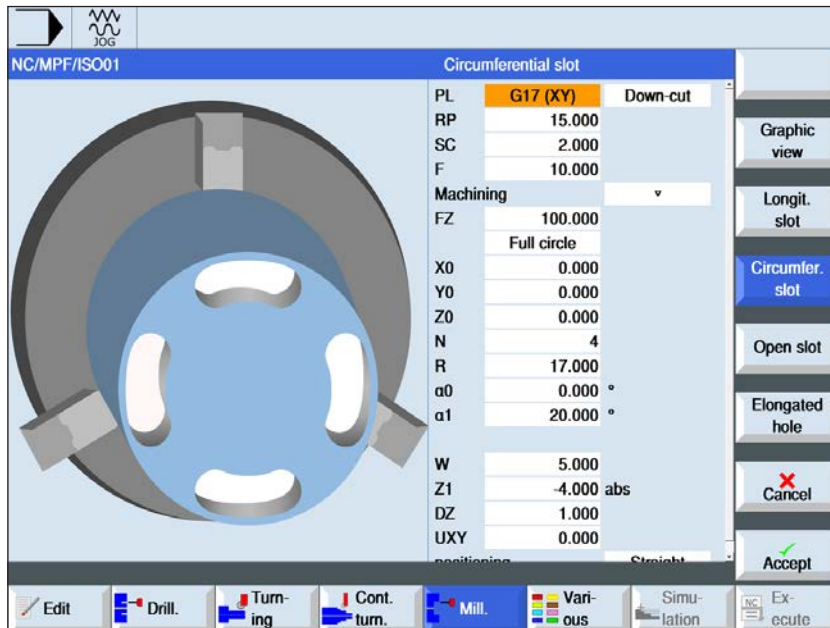

The "Select" button gives you the option to change parameters and/or units. To do this move the cursor to the appropriate field and press button.

Parameter	Description	Unit
PL	Machining plane: <ul style="list-style-type: none"> • G17 (XY) • G19 (YZ) if nothing is selected, the status of the last setting applies	
RP	Retract plane	mm
Milling direction	<ul style="list-style-type: none"> • Up-cut milling • Down-cut milling 	
SC	Safety distance	mm
F	Feed	mm/min
Machining	<ul style="list-style-type: none"> • ▾ Roughing • ▾ ▾ Finishing • ▾ ▾ ▾ Edge finishing • Chamfering 	
FZ FX	Infeed depth	mm/min
Circle template	<ul style="list-style-type: none"> • Full circle The circumferential slots will be positioned on a full circle. The distance from one circumferential slot to the next circumferential slot is always the same and will be calculated by the control system. • partial circle The circumferential slots will be positioned on a partial circle. The distance from one circumferential slot to the next circumferential slot is defined by the angle $\alpha 2$. 	

Parameter	Description	Unit
X0 Y0 Z0	The positions are relative to the reference point: Reference point in X, Y and Z. Only for individual position	mm
N	Number of slots	
R	Radius of the circumferential slot	mm
α_0	Start angle	degrees
α_1	Opening angle of the groove	degrees
α_2	Angle of advance (only with partial circle)	degrees
W	Width of the slot	mm
Z1	Slot depth (absolute) or depth relative to Z0 (incremental) (only if ∇ , $\nabla \nabla \nabla$, or $\nabla \nabla \nabla$ edge)	mm
DZ DX	Maximum infeed depth (only if ∇ , $\nabla \nabla \nabla$, or $\nabla \nabla \nabla$ edge)	mm
FS	Bevel width for chamfering (only for chamfering)	mm
ZFS XFS	Tool tip plunge depth (absolute or incremental) (only for chamfering)	mm
UXY UYZ	Finishing pass plane (only if ∇ , $\nabla \nabla \nabla$, or $\nabla \nabla \nabla$ edge)	mm
Positioning	Positioning movement between the slots: <ul style="list-style-type: none"> • Straight line: next position will be approached in rapid traverse in a straight line. • Circle: next position will be approached on a circular path with the programmed feed. 	

**Instructions:**

Enter to create a circumferential slot for number (N)=1 and opening angle (α_1) = 360°.

Cycle description

1 The control system positions the tool in rapid traverse (G0) at the retract plane height on the center point of the half circle at the slot end and at the safety distance. The start point lies on the positive X-axis rotated by α_0 .

2 The tool mills into the material with the machining feed according to the selected strategy. The max. infeed in the Z-direction as well as the finishing pass will be taken into account.

3a Machining ▽ ▽ ▽ Roughing

During roughing the individual planes of the slot will be processed from the centre point of the half circle at the slot end until the depth Z1 is reached.

Minimum diameter of the milling tool: $\frac{1}{2}$ Slot width W – Finishing pass $UXY \leq$ Milling cutting tool diameter

3b Machining ▽ ▽ ▽ Finishing

During finishing the edge will always be processed first, until depth Z1 is reached. In the process the slot edge will be approached in the quarter circle in which it joins the radius. With the last feed there will be finished from the center point of the semi-circle at the slot end from the center.

Minimum diameter of the milling tool: $\frac{1}{2}$ Slot width $W \leq$ milling cutter tool

3c Machining ▽ ▽ ▽ Edge finishing

Edge finishing takes place as with finishing. Only the last infeed (bottom finishing) is absent.

Minimum diameter of the milling tool: Finishing pass $UXY \leq$ milling cutter tool diameter

3d Machining - chamfering

During chamfering the edge on the top of the circular slot will be breached.

4 Once the first circumferential slot is finished, the tool moves in rapid traverse to the retract plane.

5 The following circumferential slot will be approached on a straight line or circular path and then milled.

6 The tool moves back to the safety distance in rapid traverse (G0).

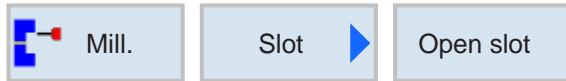

Open slot (CYCLE899)



The "Select" button gives you the option to change parameters and/or units. To do this move the cursor to the appropriate field and press button.

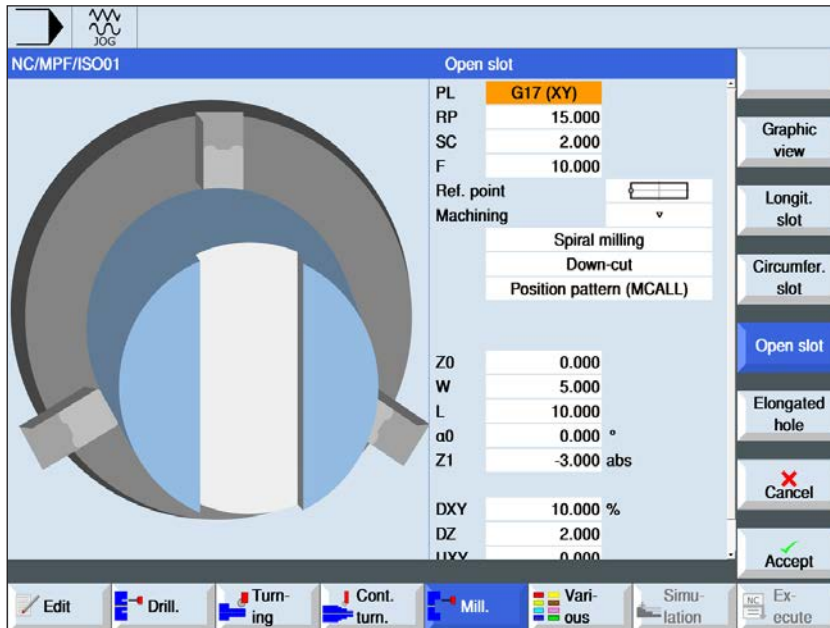

Parameter	Description	Unit
PL	Machining plane: <ul style="list-style-type: none"> G17 (XY) G19 (YZ) if nothing is selected, the status of the last setting applies	
RP	Retract plane	mm
SC	Safety distance	mm
Milling direction	Only trochoidal milling: <ul style="list-style-type: none"> Up-cut milling Down-cut milling Up-cut - down-cut milling 	
F	Feed	mm/min
Reference point	<ul style="list-style-type: none"> (left edge) (center) (right edge) 	
Machining	<ul style="list-style-type: none"> ▽ Roughing ▽▽ Pre-finishing ▽▽▽ Finishing ▽▽▽ Floor finishing ▽▽▽ Edge finishing Chamfering 	
Technology	<ul style="list-style-type: none"> Trochoidal milling Circular movement of the mill through the slot and back again. Plunge milling Sequential drilling movements along the tool axis. 	

Parameter	Description	Unit
Machining position	<ul style="list-style-type: none"> Individual position Mill slot at the programmed position (X0, Y0, Z0). Position template Mill several slots on a programmed position template (e.g.: full circle or grid). 	
X0 Y0 Z0	The positions are relative to the reference point: Reference point in X, Y and Z. Only for individual position	mm
W	Width of the slot	mm
L	Length of the slot	mm
α_0	Angle of the slot	degrees
Z1 X1	Slot depth (absolute) or depth relative to Z0 (incremental) (only if ∇ , $\nabla \nabla$, $\nabla \nabla \nabla$, $\nabla \nabla \nabla \nabla$ floor or $\nabla \nabla \nabla$ edge)	mm
DX DYZ	<ul style="list-style-type: none"> maximum plane infeed Position template maximum level infeed as a percentage of the mill diameter (only when ∇) 	mm %
DZ DX	Maximum infeed depth (only if ∇ , $\nabla \nabla$, $\nabla \nabla \nabla$, or $\nabla \nabla \nabla \nabla$ edge)	mm
UXY UYZ	Finishing pass plane (slot edge) - (only if ∇ , $\nabla \nabla$, or $\nabla \nabla \nabla$ floor)	mm
UZ UX	Finishing pass depth (slot floor) - (only if ∇ , $\nabla \nabla$, or $\nabla \nabla \nabla$ edge)	mm
FS	Tool tip plunge depth (absolute or incremental) - (only for chamfering)	mm
ZFS XFS	Tool tip plunge depth (absolute or incremental) - (only for chamfering)	mm

General limit conditions:

- Finishing 1/2 slot width $W \leq$ mill diameter
- Finishing edge finishing pass $UXY \leq$ mill diameter
- Chamfer tip angle must be registered in tool table.

Limit conditions for trochoidal milling:

- Roughing: 1/2 Slot width $W -$ Finishing pass $UXY \leq$ Milling cutting tool diameter
- Slot width: at least 1.15x mill diameter + finishing pass at most 2x mill diameter + 2x finishing pass
- Radial infeed: at least 0.02x mill diameter, at most 0.25x mill diameter
- Maximum infeed depth \leq Cutting height of the mill

Limit conditions for plunge milling:

- Roughing: 1/2 Slot width $W -$ Finishing pass $UXY \leq$ Milling cutting tool diameter
- Maximum radial infeed: The maximum infeed is dependent on the cutting width of the mill.
- Increment: The sideways increment results from the desired slot width, the milling cutting tool diameter and the finishing pass.
- Retraction: The retraction takes place with withdrawal at an angle of 45°, if the wrap angle is less than 180°. Otherwise a vertical retraction takes place as with drilling.
- Withdrawal: The withdrawal takes place vertically in relation to the wrapped surface.
- Safety distance: Move the safety distance beyond the end of the workpiece to avoid rounding of the slot walls at the ends.

The cutting width of the mill for the maximum radial infeed cannot be tested.

Cycle description**Trochoidal milling**

1 The control system positions the tool in rapid traverse (G0) at the start point in front of the groove and at the safety distance. The start point lies on the positive X-axis rotated by $\alpha 0$.

2 The tool feeds in to the cut depth.

3 The open slot is always machined with the selected machining type over the complete slot length.

3a Machining ▾ Roughing

The roughing is carried out with a circular movement of the mill cutting tool. During these movement the mill will be continually fed further into the plane. If the mill tool has traced the entire slot, the mill also moves back in a circular movement and in this way drops to the next level (infeed depth) in the Z-direction. This procedure repeats until the preset slot depth plus finishing pass is reached.

3b Machining ▾ ▾ Pre-finishing

If there is too much residual material on the slot walls, superfluous corners will be cleared away to the finishing pass.

3c Machining ▾ ▾ ▾ Finishing

When finishing the walls the mill moves along the slot walls, in which, as with roughing in the Z-direction, also against is feed in step by step. In this the mill moves over the slot start and slot end by the safety distance, in order to guarantee that the slot wall has an even surface over the entire length of the slot.

3d Machining ▾ ▾ ▾ Floor finishing

In bottom finishing the mill moves into the finished slot once and once back.

3e Machining ▾ ▾ ▾ Edge finishing

Edge finishing takes place as with finishing. Only the last infeed (bottom finishing) is absent.

3f Machining - chamfering

During chamfering the edge on the top of the slot will be breached.

4 The tool moves back to the safety distance in rapid traverse (G0).

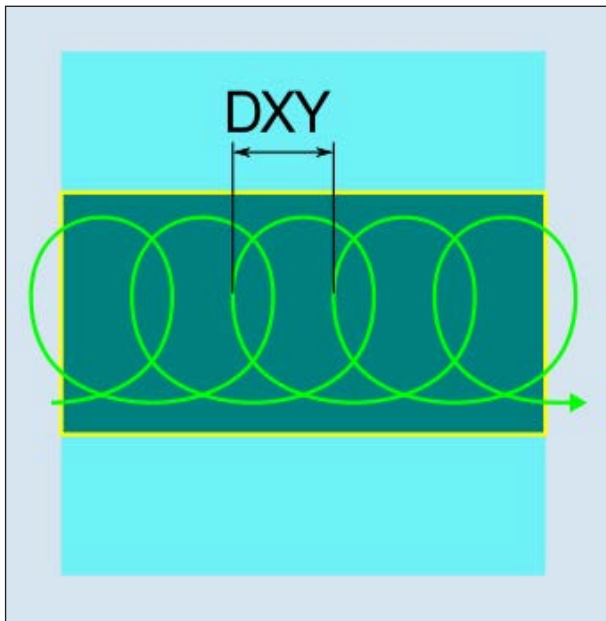

Down-cut or up-cut milling - plunge milling

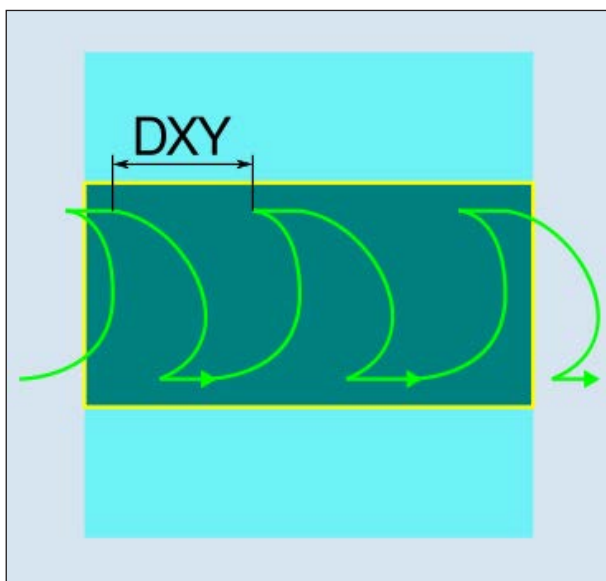

Down-cut milling/Up-cut milling - trochoidal milling

Cycle description**Plunge milling**

- 1 The control system positions the tool in rapid traverse (G0) at the start point in front of the groove and at the safety distance. The start point lies on the positive X-axis rotated by α_0 .
- 2 The open slot is always machined with the selected machining type over the complete slot length.

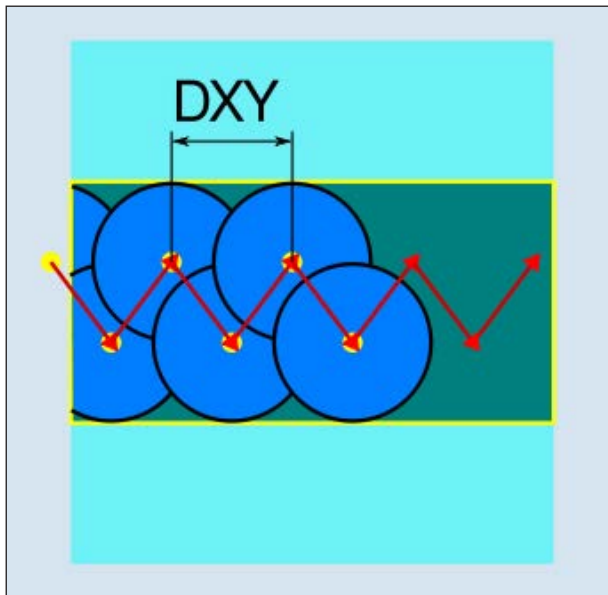

Down-cut or up-cut - plunge milling

3a Machining ▾ Roughing

The roughing of the slot takes place sequentially along the slot through vertical plunge movements of the mill with work feed. Afterwards there is a withdrawal and a position movement to the next plunge point. There will be alternate plunging on the left and right wall, along the slot, displaced by the infeed amount in each case. The first plunge movement takes place at the edge of the slot with a mill operation of a half infeed minus the safety distance. (Thus in the open air if the safety distance is larger than the infeed.) For this cycle the maximum width of the slot must be smaller than the double width of the mill + finishing pass. After each plunging movement the mill also lifts up by the safety distance at working feed. This happens according to possibility in the so-called retract procedure, i.e. when the mill has a contact angle of less than 180° it lifts under 45° in the opposite direction of the angle bisector of the contact angle from the bottom. Then the mill moves over the material.

3b Machining ▾ ▾ Pre-finishing

If there is too much residual material on the slot walls, superfluous corners will be cleared away to the finishing pass.

3c Machining ▾ ▾ ▾ Finishing

When finishing the walls the mill moves along the slot walls, in which, as with roughing in the Z-direction, also against its feed in step by step. In this the mill moves over the slot start and slot end by the safety distance, in order to guarantee that the slot wall has an even surface over the entire length of the slot.

3d Machining ▾ ▾ ▾ Floor finishing

In bottom finishing the mill moves into the finished slot once and once back.

3e Machining ▾ ▾ ▾ Edge finishing

Edge finishing takes place as with finishing. Only the last infeed (bottom finishing) is absent.

3f Machining - chamfering

During chamfering the edge on the top of the slot will be breached.

- 4 The tool moves back to the safety distance in rapid traverse (G0).

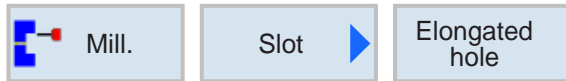

Long hole (LONGHOLE)

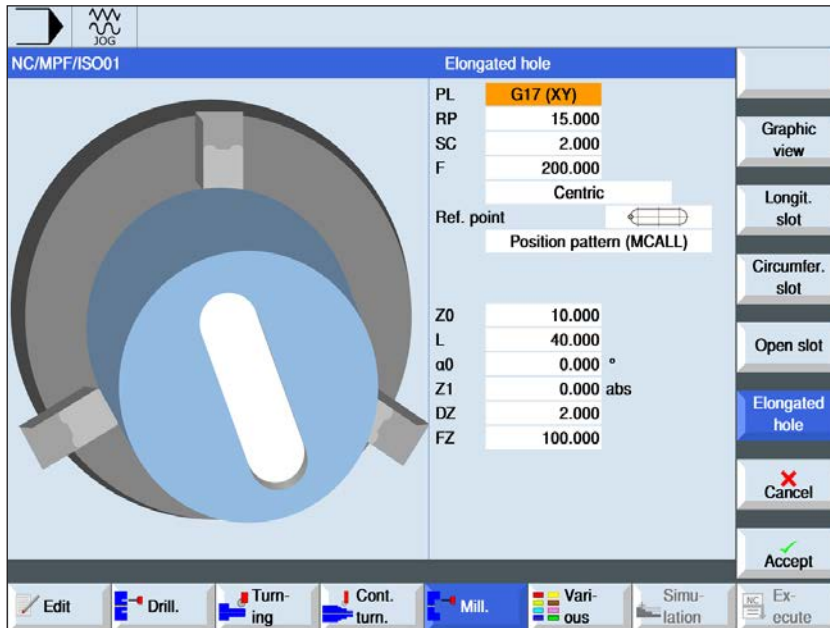

The "Select" button gives you the option to change parameters and/or units. To do this move the cursor to the appropriate field and press button.

Parameter	Description	Unit
PL	Machining plane: <ul style="list-style-type: none"> G17 (XY) G19 (YZ) if nothing is selected, the status of the last setting applies	
RP	Retract plane	mm
SC	Safety distance	mm
F	Feed	mm/min
Machining type	<ul style="list-style-type: none"> planar It will be moved to the center of the pocket at the infeed depth. With this setting the milling cutting tool must cut via the center. swinging Plunge swinging on the center axis of the longitudinal groove: The center of the milling cutter swings on a straight line back and forth till it reaches the depth infeed. Once the depth has been reached, the path will be executed again without the depth infeed, in order to overcome the angular path of the plunge. 	
Reference point	<ul style="list-style-type: none"> (left edge) (inside left) (center) (inside right) (right edge) 	

Parameter	Description	Unit
Machining position	<ul style="list-style-type: none"> Individual position Mill elongated hole at the programmed position (X0, Y0, Z0). Position template Mill several elongated holes at the programmed position template (e.g. partial circle, grid, line). 	
X0 Y0 Z0	The positions are relative to the reference point: (only for "single position") Reference point in X, Y and Z	mm
L	Length of the elongated hole	mm
$\alpha 0$	Angle	degrees
Z1 X1	Elongated hole depth (absolute) or depth related to Z0 (incremental)	mm
DZ DX	maximum depth infeed	mm
FZ FX	Infeed depth	mm/min

Instructions:

The cycle can only be processed with a milling tool that is fitted with an end tooth cutting via the center.

**Cycle description**

- 1 The control system positions the tool with rapid traverse (G0) at the start position for the cycle. In both axes of the current plane the next end point of the first longitudinal hole to be machined at the height of the retract plane (RC) will be approached in the tool axis. Afterwards there will be a drop to the reference point brought forward by the safety distance (SC).
- 2 Each longitudinal hole will be milled out in a swinging movement. The machining in the plane takes place with G1 and the programmed feed value. At each reversal point the infeed to the next machining depth calculated inside the cycle takes place with G1 and the feed, until the end depth is reached.
- 3 The tool moves back to the retract plane in rapid traverse (G0). The next longitudinal hole will be approached by the shortest path.
- 4 After the machining of the last longitudinal hole is finished, the tool will move to the position last reached in the machining plan to the retract plane with G0.



Thread milling (CYCLE70)

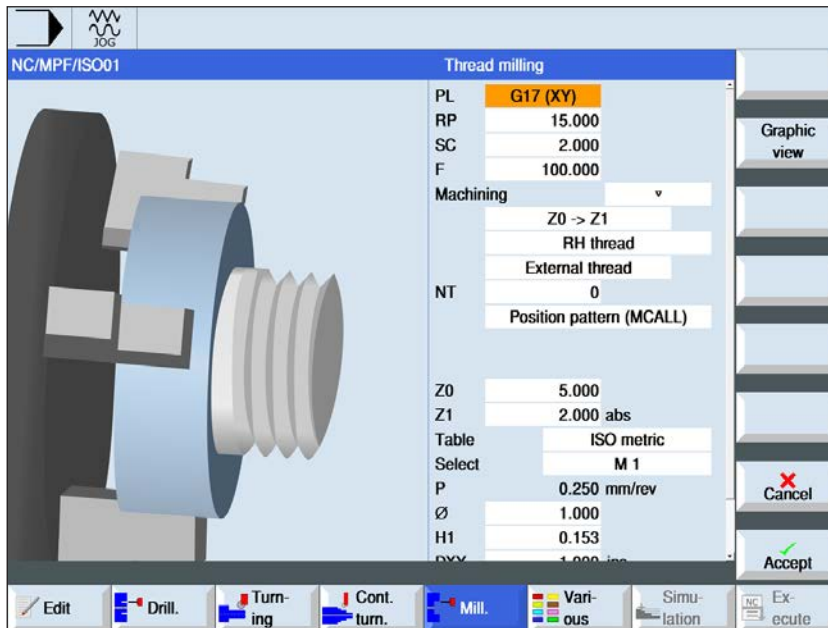

The "Select" button gives you the option to change parameters and/or units. To do this move the cursor to the appropriate field and press button.

Parameter	Description	Unit
PL	Machining plane: <ul style="list-style-type: none"> G17 (XY) G19 (YZ) if nothing is selected, the status of the last setting applies	
RP	Retract plane	mm
SC	Safety distance	mm
F	Feed	mm/min
Machining	<ul style="list-style-type: none"> ▾ Roughing ▾ ▾ ▾ Finishing 	
Machining direction	<ul style="list-style-type: none"> Z0 → Z1 Top-down machining Z1 → Z0 Bottom-up machining 	
Thread's direction of rotation	<ul style="list-style-type: none"> Right-hand thread A right-hand thread will be milled. Left-hand thread A left-hand thread will be milled. 	
Thread position	<ul style="list-style-type: none"> Internal thread An internal thread will be milled. External thread An external thread will be milled. 	

Parameter	Description	Unit
NT	Number of teeth per blade Single or multi-tooth milling inserts can be used. The required movements will be executed by the cycle internally in such a way that upon reaching the thread end position the tip of the lower tooth of a milling insert matches the programmed end position. Depending on the blade geometry a clearance path at the bottom of the workpiece has to be taken into account.	
Machining position	<ul style="list-style-type: none"> Individual position Mill elongated hole at the programmed position (X0, Y0, Z0). Position template Mill several elongated holes at the programmed position template (e.g. partial circle, grid, line). 	
X0 Y0 Z0	The positions are relative to the reference point: (only for "single position") Reference point in X, Y and Z	mm
Z1 X1	End point of the thread (absolute) or thread length (incremental)	mm
Table	Thread selection table: <ul style="list-style-type: none"> none ISO metric Whitworth BSW Whitworth BSP UNC 	
Selection	Selection of the table value e.g.: <ul style="list-style-type: none"> M1; M5; etc. (ISO metric) W1/8"; etc. (Whitworth BSW) G 1 3/4"; etc. (Whitworth BSP) N8 - 32 UNC; etc. (UNC) (also see thread table with respective pitches)	
P	Display of the thread lead (only with table selection "none") <ul style="list-style-type: none"> in MODULE: $MODULE = \text{pitch}/\pi$ in threads per inch: as is typical with pipe threads. With the per inch input, in the first parameter field the whole number before the decimal point is entered and in the second and third field the number after the decimal point is entered as a fraction. in mm/rev in inches/rev The thread lead is dependent on the tool used.	MODULE Threads/" mm/rev in/rev
∅	Nominal diameter, Example: Nominal diameter of M12 = 12 mm	mm
H1	Thread depth	mm
DXY DYZ	maximum plane infeed	mm
αS	Start angle	degrees
U	Finishing pass in X and T – (only for ▽ roughing)	mm

Thread table

ISO_METRIC		WHITWORTH_BSW		WHITWORTH_BSP		UNC	
M 1	0.250	W 1/16"	60.000	G 1/16"	28.000	N 1 - 64 UNC	64.000
M 1.2	0.250	W 3/32"	48.000	G 1/8"	28.000	N 2 - 56 UNC	56.000
M 1.6	0.350	W 1/8"	40.000	G 1/4"	19.000	N 3 - 48 UNC	48.000
M 2	0.400	W 5/32"	32.000	G 3/8"	19.000	N 4 - 40 UNC	40.000
M 2.5	0.450	W 3/16"	24.000	G 1/2"	14.000	N 5 - 40 UNC	40.000
M 3	0.500	W 7/32"	24.000	G 5/8"	14.000	N 6 - 32 UNC	32.000
M 3.5	0.600	W 1/4"	20.000	G 3/4"	14.000	N 8 - 32 UNC	32.000
M 4	0.700	W 5/16"	18.000	G 7/8"	14.000	N 10 - 24 UNC	24.000
M 4.5	0.750	W 3/8"	16.000	G 1"	11.000	N 12 - 24 UNC	24.000
M 5	0.800	W 7/16"	14.000	G 1 1/8"	11.000	1/4" - 20 UNC	20.000
M 6	1.000	W 1/2"	12.000	G 1 1/4"	11.000	5/16" - 18 UNC	18.000
M 8	1.250	W 9/16"	12.000	G 1 3/8"	11.000	3/8" - 16 UNC	16.000
M 10	1.500	W 5/8"	11.000	G 1 1/2"	11.000	7/16" - 14 UNC	14.000
M 12	1.750	W 3/4"	10.000	G 1 3/4"	11.000	1/2" - 13 UNC	13.000
M 14	2.000	W 7/8"	9.000	G 2"	11.000	9/16" - 12 UNC	12.000
M 16	2.000	W 1"	8.000	G 2 1/4"	11.000	5/8" - 11 UNC	11.000
M 18	2.500	W 1 1/8"	7.000	G 2 1/2"	11.000	3/4" - 10 UNC	10.000
M 20	2.500	W 1 1/4"	7.000	G 2 3/4"	11.000	7/8" - 9 UNC	9.000
M 22	2.500	W 1 3/8"	6.000	G 3"	11.000	1" - 8 UNC	8.000
M 24	3.000	W 1 1/2"	6.000	G 3 1/4"	11.000	1 1/8" - 7 UNC	7.000
M 27	3.000	W 1 5/8"	5.000	G 3 1/2"	11.000	1 1/4" - 7 UNC	7.000
M 30	3.500	W 1 3/4"	5.000	G 3 3/4"	11.000	1 3/8" - 6 UNC	6.000
M 33	3.500	W 1 7/8"	4.500	G 4"	11.000	1 1/2" - 6 UNC	6.000
M 36	4.000	W 2"	4.500	G 5"	11.000	1 3/4" - 5 UNC	5.000
M 39	4.000	W 2 1/4"	4.000	G 6"	11.000	2" - 4 1/2 UNC	4.500
M 42	4.500	W 2 1/2"	4.000			2 1/4" - 4 1/2 UNC	4.500
M 45	4.500	W 2 3/4"	3.500			2 1/2" - 4 UNC	4.000
M 48	5.000	W 3"	3.500			2 3/4" - 4 UNC	4.000
M 52	5.000	W 3 1/4"	3.250			3" - 4 UNC	4.000
M 56	5.500	W 3 1/2"	3.250			3 1/4" - 4 UNC	4.000
M 60	5.500	W 3 3/4"	3.000			3 1/2" - 4 UNC	4.000
M 64	6.000	W 4"	3.000			3 3/4" - 4 UNC	4.000
M 68	6.000					4" - 4 UNC	4.000

Thread table with pitches

Cycle description**Internal thread**

- 1 The control system positions the tool in the spindle axis in rapid traverse (G0) to the safety distance above the reference point.
- 2 Approach start point of the inward circular arc in the current plane with rapid traverse.
- 3 Infeed with rapid traverse to a start point in the tool axis calculated internally by the control system.
- 4 Inward arc movement at thread diameter at programmed feed to an inward arc calculated internally by the control system, taking into account the finishing pass and maximum infeed depth.
- 5 Thread milling on a spiral path in the clockwise direction or in the counter-clockwise direction (dependent on left-hand/right-hand thread, with number of blade teeth in a milling insert (NT) ≥ 2 only 1 revolution, displaced in the Z-direction).
- 6 Outward movement on a circular path with the same direction of rotation and the programmed feed.
- 7 With a programmed number of thread pitches per blade NT > 2 the tool will be infed by the number NT-1 in the Z-direction (offset). Repeat points 4 to 7 until the programmed thread depth is reached.
- 8 If the plane infeed is smaller than the thread depth, points 3 to 7 will be repeated until the thread depth + programmed extent is reached.
- 9 The tool moves back in rapid traverse (G0) to the coordinates of the thread center on the retraction plane.

Limit conditions for internal thread milling:

During internal thread milling the milling cutting tool diameter may not exceed the following value:
 mill diameter $<$ (Nominal diameter - 2x thread depth H1)

Cycle description**External thread**

- 1 The control system positions the tool in the spindle axis in rapid traverse (G0) to the safety distance above the reference point.
- 2 Approach start point of the inward circular arc in the current plane with rapid traverse.
- 3 Infeed with rapid traverse to a start point in the tool axis calculated internally by the control system.
- 4 Inward arc movement at thread diameter at programmed feed to an inward arc calculated internally by the control system, taking into account the finishing pass and maximum infeed depth.
- 5 Thread milling on a spiral path in the clockwise direction or in the counter-clockwise direction (dependent on left-hand/right-hand thread, with (NT) ≥ 2 only 1 revolution, displaced in the Z-direction).
- 6 Outward movement on a circular path in the direction opposite to that set for rotation and the programmed feed.
- 7 With a programmed number of thread pitches per blade NT > 2 the tool will be infed by the number NT-1 in the Z-direction (offset). Repeat points 4 to 7 until the programmed thread depth is reached.
- 8 If the plane infeed is smaller than the thread depth, points 3 to 7 will be repeated until the thread depth + programmed extent is reached.
- 9 The tool moves back in rapid traverse (G0) to the coordinates of the thread center on the retraction plane.



Engraving (CYCLE60)

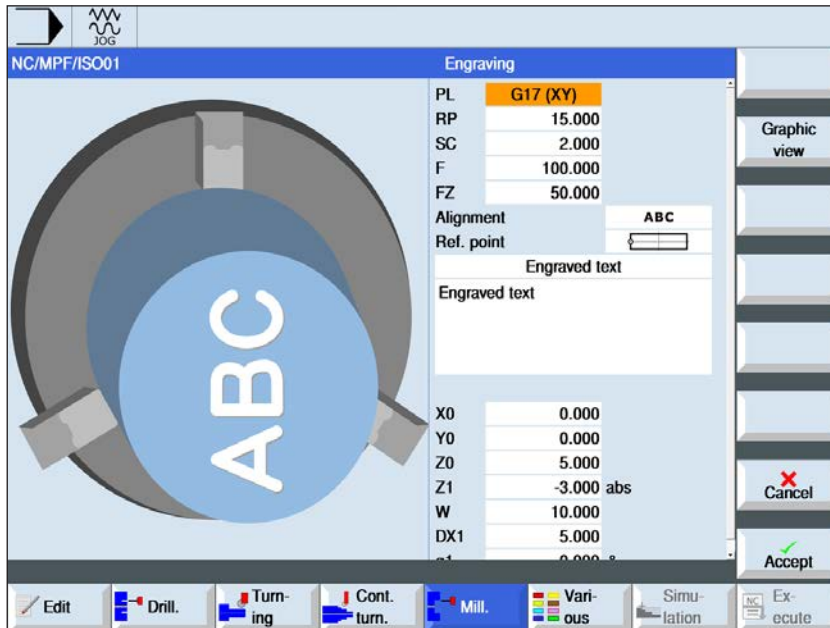

The "Select" button gives you the option to change parameters and/or units. To do this move the cursor to the appropriate field and press button.

Parameter	Description	Unit
PL	Machining plane: • G17 (XY) • G19 (YZ) if nothing is selected, the status of the last setting applies	
RP	Retract plane	mm
SC	Safety distance	mm
F	Feed	mm/min
FZ	Infeed depth	mm/min mm/tooth
Alignment	<ul style="list-style-type: none"> • (Linear alignment) • (Curved alignment) • (curved alignment) 	
Reference point	<ul style="list-style-type: none"> • (bottom left) • (bottom right) • (bottom center) • (top left) • (top right) • (top center) • (left edge) • (center) • (right edge) 	

Parameter	Description	Unit
X0 or R Y0 or α Z0	Reference point X or reference point polar length Y or reference point polar angle Reference point Z	mm mm or degrees mm
Engraving text Variable name	<ul style="list-style-type: none"> Engraved text (max. 100 characters) Variable name: <code>_TXT[1]</code>: string variable, in which the text is stored: has to be defined earlier in the program. 	
Z1 X1	Engraving depth (absolute) or depth related to Z0 or X0 (incremental)	mm
W	Symbol height	mm
DX1 or DX2 DY1 or DY2	Character spacing or total width (only for linear alignment)	mm degrees
DX1 or $\alpha 2$ DY1 or $\alpha 2$	Character spacing or opening angle (only for curved alignment)	mm degrees
$\alpha 1$	Text direction (only for linear alignment)	degrees
XM or LM	Center X (abs) or center polar length – (only for curved alignment)	mm
YM or αM	Center Y (abs) or center polar length – (only for curved alignment)	mm

Cycle description

- 1 The control system positions the tool in the spindle axis in rapid traverse (G0) to the safety distance above the start point.
- 2 The tool moves with infeed FZ to the machining depth Z1 and mills the symbol.
- 3 The tool withdraws to the safety distance in rapid traverse and moves in a straight line to the next symbol.
- 4 Steps 2 and 3 will be repeated until the whole text has been milled.
- 5 The tool moves back in rapid traverse (G0) to the coordinates of the thread center on the retraction plane.



Contour milling

- New contour
- Contour call-up (CYCLE62)
- Path milling (CYCLE72)
- Pre-drilling(CYCLE64)
- Pocket (CYCLE63)
- Spigot (CYCLE63)

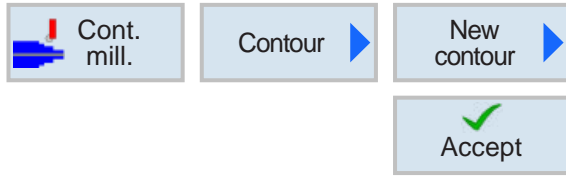

Create new contour

- Enter contour name and confirm with softkey. If the program name exists already, an error machine pops up with a prompt to enter a new name.

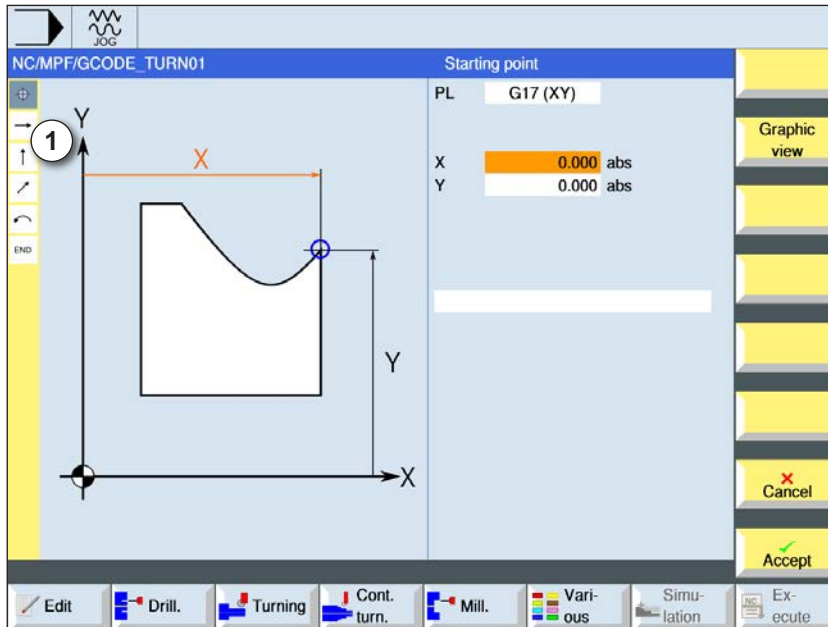

Instructions:
The individual contour elements of a contour will be shown symbolically in the indicated sequence on the left alongside the graphic window (1).

1 Contour element

- Then the start point of the contour will be entered.
- If applicable, enter additional commands in the form of G-Code.
- Press softkey to apply the cycle in the workpiece program.
- Enter individual contour elements and apply with softkey:

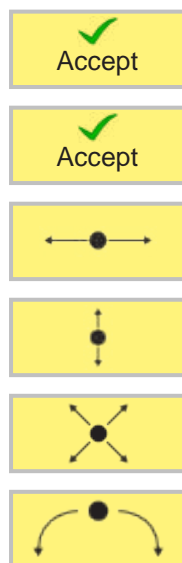

Straight line element in Z

Straight line element in Y

Straight line element in XY

Circular element



Contour element straight line X

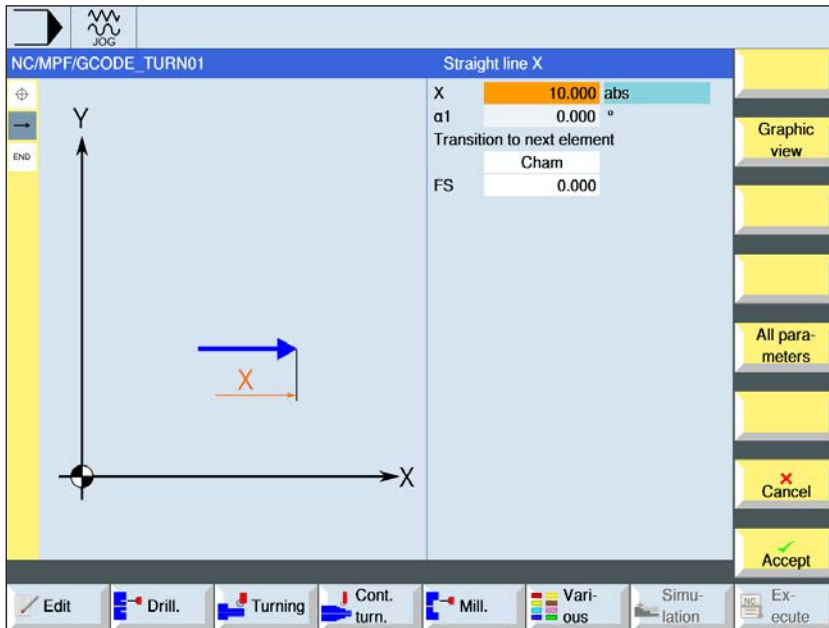

The "Select" button gives you the option to change parameters and/or units. To do this move the cursor to the appropriate field and press button.

Parameter	Description	Unit
X	End point X (absolute or incremental)	mm
$\alpha 1$	Start angle e.g. to X-axis	degrees
$\alpha 2$	Angle to previous element	degrees
Transition to succeeding element	Type of transition <ul style="list-style-type: none"> • Radius • Bevel 	
R	Transition to succeeding element - Radius	mm
FS	Transition to succeeding element - Bevel	mm
Additional commands	Additional G-code commands	



Contour element straight line Y

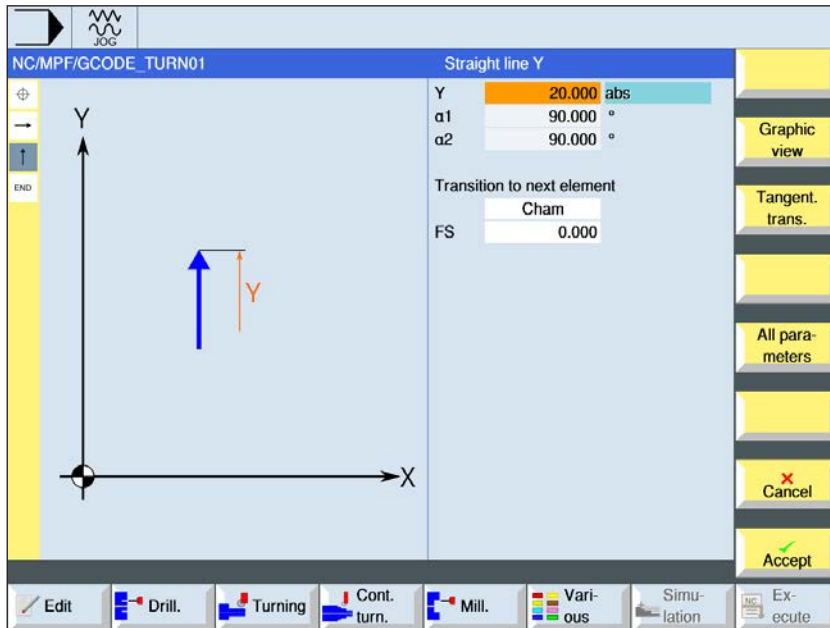

The "Select" button gives you the option to change parameters and/or units. To do this move the cursor to the appropriate field and press button.

Parameter	Description	Unit
Y	End point Y (absolute or incremental)	mm
$\alpha 1$	Start angle e.g. to X-axis	degrees
$\alpha 2$	Angle to previous element	degrees
Transition to succeeding element	Type of transition <ul style="list-style-type: none"> • Radius • Bevel 	
R	Transition to succeeding element - Radius	mm
FS	Transition to succeeding element - Bevel	mm
Additional commands	Additional G-code commands	



Contour element straight line XY

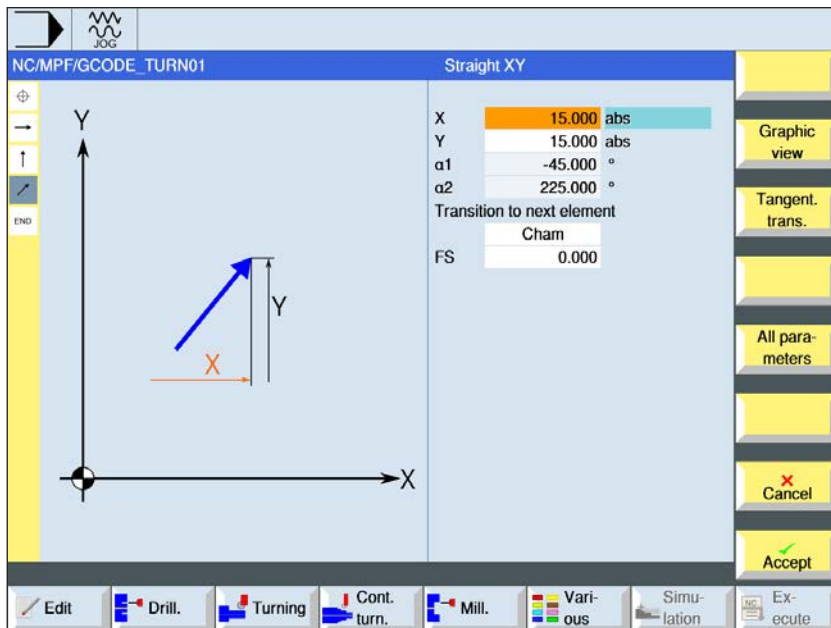

The "Select" button gives you the option to change parameters and/or units. To do this move the cursor to the appropriate field and press button.

Parameter	Description	Unit
X	End point X (absolute or incremental)	mm
Y	End point Y (absolute or incremental)	mm
L	Length	mm
$\alpha 1$	Start angle e.g. to X-axis	degrees
$\alpha 2$	Angle to previous element	degrees
Transition to succeeding element	Type of transition <ul style="list-style-type: none"> • Radius • Bevel 	
R	Transition to succeeding element - Radius	mm
FS	Transition to succeeding element - Bevel	mm
Additional commands	Additional G-code commands	



Contour element circle

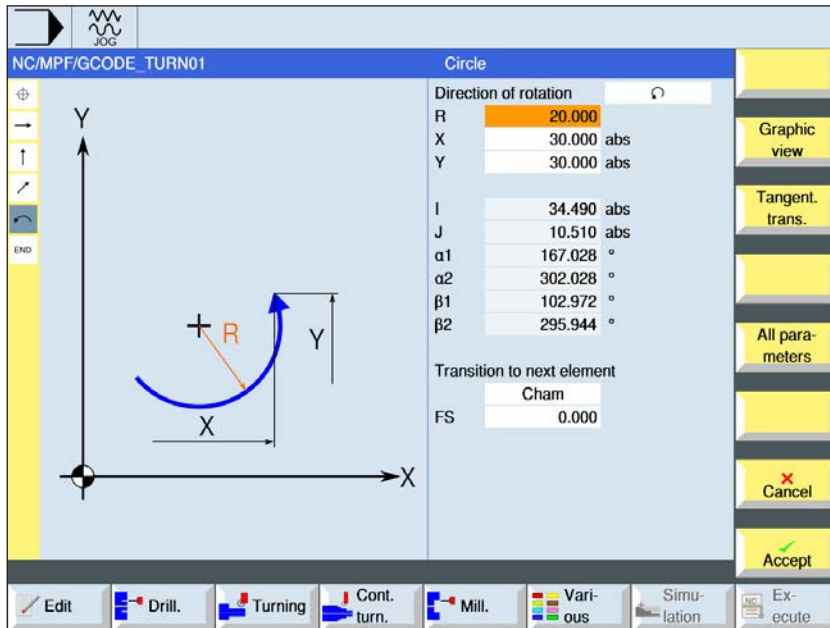

The "Select" button gives you the option to change parameters and/or units. To do this move the cursor to the appropriate field and press button.

Parameter	Description	Unit
Direction of rotation	<ul style="list-style-type: none"> Direction of rotation right Direction of rotation left 	
R	Radius	mm
X Y	Coordinates of the end points in X and Y (absolute or incremental)	mm
I J	Coordinates of the circle centre in I and J (absolute or incremental)	mm
$\alpha 1$	Start angle to X-axis	degrees
$\alpha 2$	Angle to previous element	degrees
$\beta 1$	End angle to Z-axis	degrees
$\beta 2$	Opening angle	degrees
Transition to succeeding element	Type of transition <ul style="list-style-type: none"> Radius Bevel 	
R	Transition to succeeding element - Radius	mm
FS	Transition to succeeding element - Bevel	mm
Additional commands	Additional G-code commands	

	Other functions:
Graphic view	<ul style="list-style-type: none">• Change view This softkey switches between the graphics window and the input screen.
Tangent. trans.	<ul style="list-style-type: none">• Tangent to previous element Program the transition to the previous element as a tangent.
Dialog select	<ul style="list-style-type: none">• Dialog selection If two different contour options result from previously entered parameters, one of them must be selected.
Dialog accept	<p>Apply the selection contour option with the softkey.</p>
Change selection	<ul style="list-style-type: none">• change dialog concerned When a dialogue selection has already been made this softkey changes the selected solution again.
all parameters	<ul style="list-style-type: none">• Show additional parameters If additional parameters should be shown for individual contour elements, e.g. to enter additional commands.
Close contour	<ul style="list-style-type: none">• Close contour The contour will be closed from the current position with a straight line to the start point.

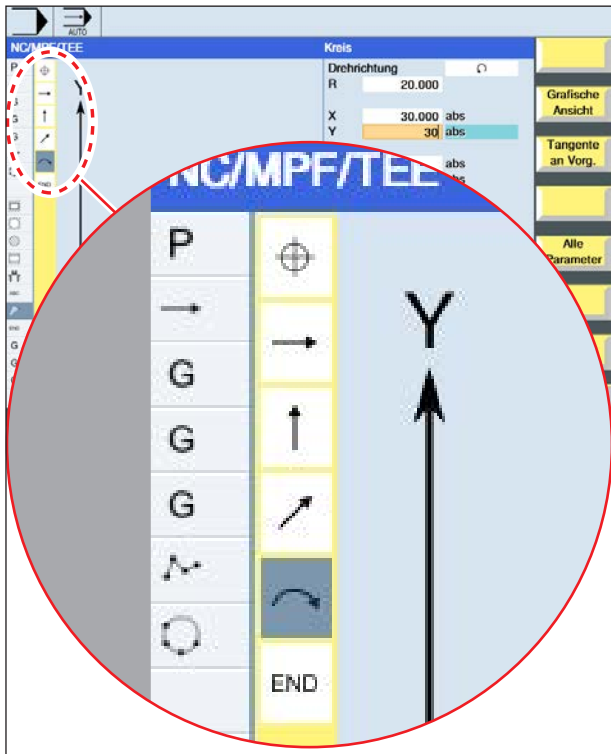

Symbol representation of the contour elements:

Contour element	Symbol	Meaning
Start point		Start point of the contour
Straight up Straight down		Straight line in 90° grid
Straight left Straight right		Straight line in 90° grid
Straight line anywhere		Straight line with arbitrary pitch
Curve right Curve left		Circle
Contour termination	END	End of the contour description

The contour element can accept different line types and colours:

- Black: Programmed contour
- Orange: Current contour element
- Line-dot-dot: Partially-defined element

The scaling of the coordinate system adapts to the change of the entire contour.

Change contour

Change contour element

- Open the program to be machined.
- Use the cursor to select the program block in which the contour should be changed. The individual contour elements will be listed.
- Position cursor at the point to insert or change.
- Use the softkey to select the desired element.
- Enter parameter in the input screen or delete the element and select a new element.
- Press Softkey. The desired contour element will be inserted or changed on the contour.



Change
selection

✓
Accept

Delete contour element

- Open the program to be machined.
- Position cursor on the contour element that should be deleted.
- Press Softkey.
- Press Softkey.

Delete
element

✓
Delete

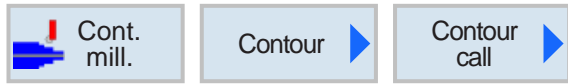

Contour call-up (CYCLE62)



The "Select" button gives you the option to change parameters and/or units. To do this move the cursor to the appropriate field and press button.

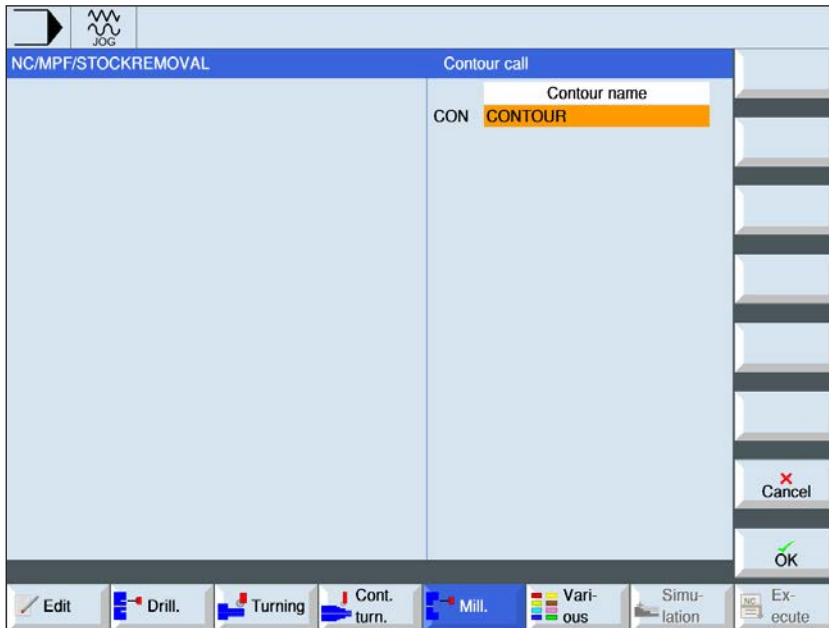

Parameter	Description	Unit
Contour selection	<ul style="list-style-type: none"> Contour name Labels Sub-routine Labels in the sub-routine 	
Contour name	CON: Contour name	
Labels	<ul style="list-style-type: none"> LAB1: Label 1 LAB2: Label 2 	
Sub-routine	PRG: Sub-routine	
Labels in the sub-routine	<ul style="list-style-type: none"> PRG: Sub-routine LAB1: Label 1 LAB2: Label 2 	

Cycle description

When a contour is called up, a reference to the selected contour is created. The following selection options exist for calling up the contour:

1 Contour name

The contour is in the main program to be called up.

2 Labels

The contour is in the main program to be called up and is restricted by the label entered.

3 Sub-routine

The contour is in a sub-routine in the same workpiece.

4 Labels in the sub-routine

The contour is in a sub-program and is restricted by the label entered.





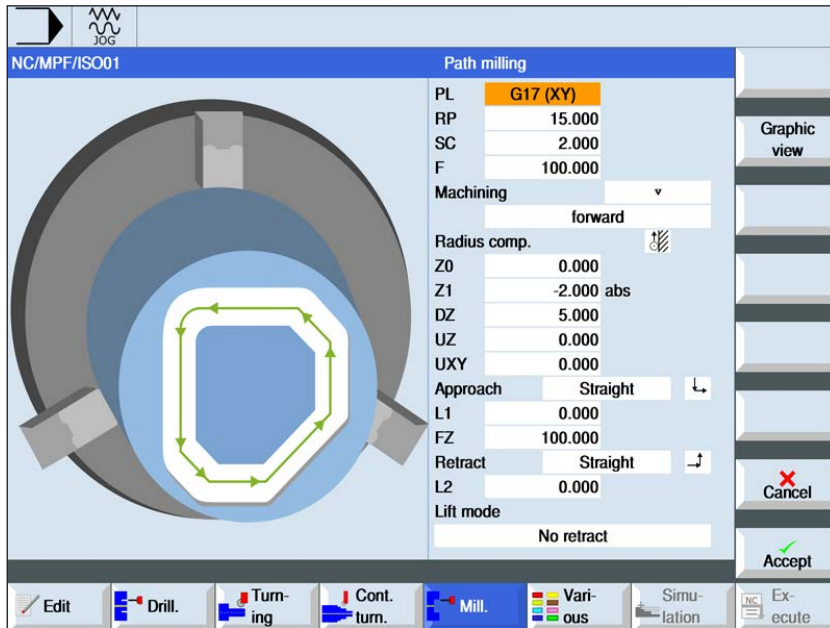

Path milling (CYCLE72)



The "Select" button gives you the option to change parameters and/or units. To do this move the cursor to the appropriate field and press button.

Parameter	Description	Unit
PL	Machining plane: <ul style="list-style-type: none"> • G17 (XY) • G19 (YZ) if nothing is selected, the status of the last setting applies	
RP	Retract plane	mm
SC	Safety distance	mm
F	Feed	mm/min
Machining	<ul style="list-style-type: none"> • ▾ Roughing • ▾ ▾ Finishing • Chamfering 	
Machining direction	<ul style="list-style-type: none"> • forwards: The processing takes place in the programmed contour direction. • backwards: The processing takes place against the programmed contour direction. 	
Radius correction	<ul style="list-style-type: none"> • left (machining left from the contour) • right (machining right from the contour) • off A programmed contour can also be programmed on the centre point path. In this, movement in or out is possible in a straight line or vertically. Moving in and out vertically can also, for example, be used with closed contours.	
X0 Z0	Reference point in Z or X	mm

Parameter	Description	Unit
Z1 X1	Final depth (absolute) or final depth relative to X0 or Z0 (incremental) (only if ▽, or ▽ ▽ ▽)	mm
DZ DX	maximum infeed depth (only if ▽, or ▽ ▽ ▽)	mm
UZ UX	Finishing pass plane (only when ▽)	mm
FS	Bevel width for chamfering - (only for machining chamfering)	mm
ZFS YFS XFS	Tool tip plunge depth (absolute or incremental) - (only for machining chamfering)	mm
UXY UYZ	Finishing pass plane (only if ▽)	mm
Approach mode	Approach mode level <ul style="list-style-type: none"> • Straight line: Slope in space • Quadrant: Part of a spiral (only when path milling left and right of the contour) • Semi-circle: Part of a spiral (only when path milling left and right of the contour) • Vertical: Vertical to path (only for path milling on the center point path) 	
Approach strategy	Only when approaching quadrant, semi-circle or straight line: <ul style="list-style-type: none"> •  axially •  three-dimensionally 	
R1	Approach radius: Only when approaching quadrant or semi-circle	mm
L1	Approach length: Only when approaching straight line	mm
FZ	Infeed depth	mm
Withdraw mode	Withdraw mode plane <ul style="list-style-type: none"> • Straight line: Slope in space • Quadrant: Part of a spiral (only when path milling left and right of the contour) • Semi-circle: Part of a spiral (only when path milling left and right of the contour) 	
Withdrawal strategy	<ul style="list-style-type: none"> •  axially •  three-dimensionally 	
R2	Withdraw radius: Only when withdrawing from quadrant or semi-circle	mm
L2	Withdraw length: Only when withdrawing from straight line	mm

Parameter	Description	Unit
Lift mode	When several depth infeeds are required, indicate retraction height to which the tool should pull back between the individual infeeds (during transition from end of the contour to the start). Lift mode before renewed infeed: <ul style="list-style-type: none"> • no retraction • on RP...retraction plane • Z0 + safety distance • by safety distance 	
FR	Retraction plan for interim positioning - (not during lifting mode "no retraction")	mm/min
FS	Bevel width for chamfering - (only for machining chamfering)	mm
ZFS	Tool tip plunge depth (absolute or incremental) (only for machining chamfering)	mm

Approach and withdrawal mode

The contour can be approached or withdrawn from in a quarter circle, semi-circle or straight line.

- For the quadrant or semi-circle the radius of the mill center point must be entered.
- With straight lines the distance from the external edge of the mill to the contour start point or contour end point must be given.

Mixed programming is also possible, e.g. approach in quarter circle.

Withdraw in semi-circle.

Strategy for approach/withdrawal

You can select between planar approach/withdrawal and three-dimensional approach/withdrawal:

- Planar approach:
first the depth and then the processing plane will be approached.
- Three-dimensional approach:
the depth and processing plane will be approached simultaneously.
- Withdrawal takes place in the reverse order.

Mixed programming is possible, e.g. approaching in the processing plane, withdrawing three-dimensionally.

Path milling on the center point path

A programmed contour can also be processed on the centre point path, if the radius correction was switched off. In this, movement in or out is possible in a straight line or vertically. Vertical approach/withdrawal can be used, for example, with closed contours.

Programming of the contour cycle with the associated contour:

A complete contour cycle consists of the associated contour and the processing cycle.

The programming sequence must be observed:

- 1 The contour will be created first and the processing cycle afterwards (e.g.: path milling). The control system links both program parts with a symbolic bracket (3) in the cycle list.
- 2 Program contour call-up (CYCLE62).
Select the contour to be processed.
- 3 Path milling (roughing)
The contour will be processed taking the indicated approach and withdrawal strategies into account.
- 4 Path milling (finishing)
If a finishing pass was programmed during roughing, the contour will be machined again.
- 5 Path milling (chamfering)
If an edge breach is anticipated, the workpiece will be milled with a special tool.



Pre-drill contour pocket (CYCLE64)

Alongside pre-drilling the centering option also exists with this cycle. For this centering or pre-drilling programs generated from the cycle are called up.

During clearing of contour pockets, when a mill cannot plunge in the center, it is necessary to pre-drill. The number and the positions of the pre-drillings required depends on special circumstances such as e.g. type of contours, tool, plane infeed, finishing pass.

Programming

- 1 Contour pocket 1
- 2 Centering
- 3 Contour pocket 2
- 4 Centering
- 5 Contour pocket 1
- 6 Preliminary drilling
- 7 Contour pocket 2
- 8 Preliminary drilling
- 9 Contour pocket 1
- 10 Clearing
- 11 Contour pocket 2
- 12 Clearing

When a pocket is being fully machined (centering, pre-drilling and clearing directly after one another), and the additional parameters for centering/pre-drilling have not been filled out, the cycle applies these parameter values from the Clearing processing step (roughing). In G-code programming, these values are to be entered again specially.



Centering (CYCLE64)

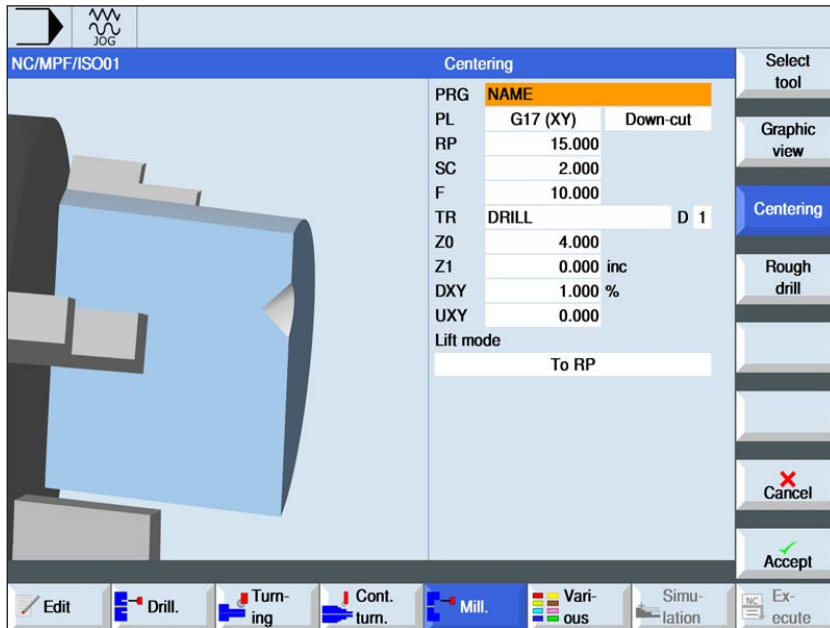

The "Select" button gives you the option to change parameters and/or units. To do this move the cursor to the appropriate field and press button.

Parameter	Description	Unit
PRG	Name for the program to be generated	
PL	Machining plane: <ul style="list-style-type: none"> • G17 (XY) • G19 (YZ) if nothing is selected, the status of the last setting applies	
RP	Retract plane	mm
Milling direction	<ul style="list-style-type: none"> • Up-cut milling • Down-cut milling 	
SC	Safety distance	mm
F	Feed	mm/min
TR	Reference tool. Tool used in the "clearing" processing step. Used to determine the plunge position.	
X0 Z0	Reference point Z or X	mm
Z1 X1	Pocket depth (absolute) or depth relative to Z0 or X0 (incremental)	mm

Parameter	Description	Unit
DXY DYZ	<ul style="list-style-type: none"> • maximum plane infeed • maximum plane infeed as a percentage of the milling cutting tool diameter 	mm %
UXY UYZ	Finishing pass plane	mm
Lift mode	<p>Lift mode before renewed infeed: If several plunge points are required during processing, the retraction height can be programmed.</p> <ul style="list-style-type: none"> • on RP • Z0 + safety distance <p>During the transition to the next plunge point the tool pulls back to this height. If there are no elements larger than Z0 in the pocket area, Z0 + safety distance can be programmed as lift mode.</p>	mm

Programming of the centering cycle with the associated contour:

A complete contour cycle consists of the associated contour and the processing cycle.

The programming sequence must be observed:

1 The contour will be created first and the machining cycle afterwards (e.g.: centering (CYCLE64)).

The control system links both program parts with a symbolic bracket (3) in the cycle list.

2 Program contour call-up (CYCLE62).
Select the contour to be processed.

3 Centering(CYCLE64)
The contour will be processed taking the indicated parameter into account.



Pre-drilling(CYCLE64)



The "Select" button gives you the option to change parameters and/or units. To do this move the cursor to the appropriate field and press button.

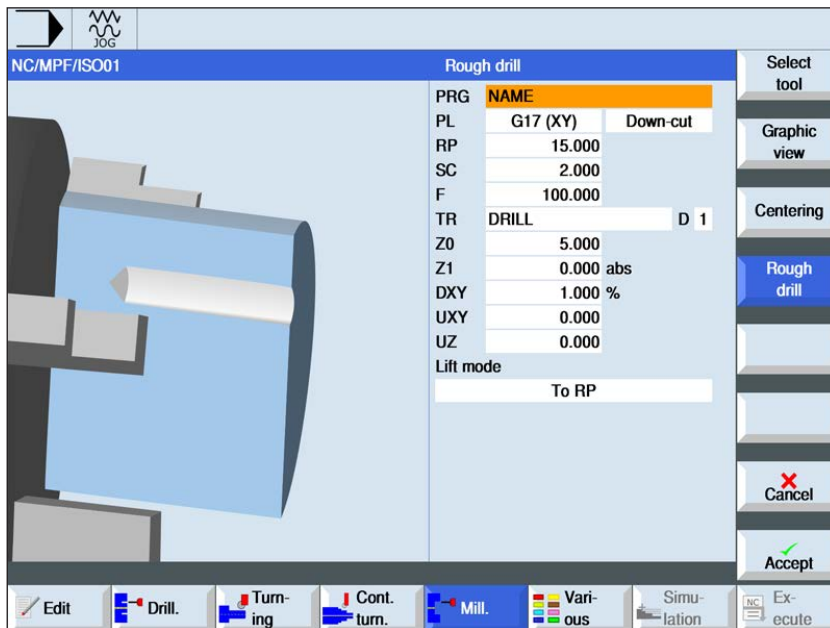

Parameter	Description	Unit
PRG	Name for the program to be generated	
PL	Machining plane: <ul style="list-style-type: none"> • G17 (XY) • G19 (YZ) if nothing is selected, the status of the last setting applies	
RP	Retract plane	mm
Milling direction	<ul style="list-style-type: none"> • Up-cut milling • Down-cut milling 	
SC	Safety distance	mm
F	Feed	mm/min
TR	Reference tool. Tool used in the "clearing" processing step. Used to determine the plunge position.	
X0 Z0	Reference point Z or X	mm
Z1 X1	Pocket depth (absolute) or depth relative to Z0 or X0 (incremental)	mm

Parameter	Description	Unit
DXY DYZ	<ul style="list-style-type: none"> • maximum plane infeed • maximum plane infeed as a percentage of the milling cutting tool diameter 	mm %
UXY UYZ	Finishing pass plane	mm
UZ UX	Finishing pass depth	mm
Lift mode	<p>Lift mode before renewed infeed: If several plunge points are required during processing, the retraction height can be programmed.</p> <ul style="list-style-type: none"> • on RP • Z0 + safety distance <p>During the transition to the next plunge point the tool pulls back to this height. If there are no elements larger than Z0 in the pocket area, Z0 + safety distance can be programmed as lift mode.</p>	mm

Programming of the pre-drilling cycle with the associated contour:

A complete contour cycle consists of the associated contour and the processing cycle.

The programming sequence must be observed:

1 The contour will be created first and the machining cycle afterwards (e.g.: pre-drilling (CYCLE64)).

The control system links both program parts with a symbolic bracket (3) in the cycle list.

2 Program contour call-up (CYCLE62).
Select the contour to be processed.

3 VPre-drilling(CYCLE64)
The contour will be processed taking the indicated parameter into account.



Mill pocket (CYCLE63)

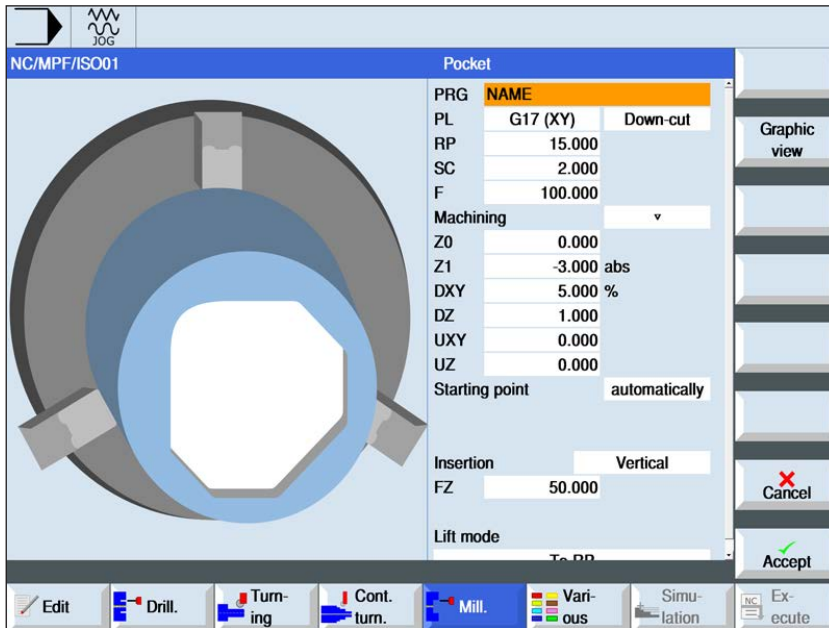

The "Select" button gives you the option to change parameters and/or units. To do this move the cursor to the appropriate field and press button.

Parameter	Description	Unit
PRG	Name for the program to be generated	
PL	Machining plane: <ul style="list-style-type: none"> • G17 (XY) • G19 (YZ) if nothing is selected, the status of the last setting applies	
RP	Retract plane	mm
Milling direction	<ul style="list-style-type: none"> • Up-cut milling • Down-cut milling 	
SC	Safety distance	mm
F	Feed	mm/min
Machining	<ul style="list-style-type: none"> • ▾ Roughing • ▾ ▾ ▾ Floor finishing • ▾ ▾ ▾ Edge finishing • Chamfering 	
X0 Z0	Reference point Z or X	mm
Z1 X1	Pocket depth (absolute) or depth relative to Z0 or X0 (incremental)	mm
DXY DYZ	<ul style="list-style-type: none"> • maximum plane infeed • maximum plane infeed as a percentage of the milling cutting tool diameter (only ▾, or ▾ ▾ ▾ floor) 	mm %

Parameter	Description	Unit
DZ DX	maximum infeed depth (only if ▽, or ▽ ▽ ▽ edge)	mm
UXY UYZ	Finishing pass plane	mm
UZ UX	Finishing pass depth	mm
Start point	<ul style="list-style-type: none"> manually Start point will be specified manually automatically Start point will be calculated automatically (only ▽, or ▽ ▽ ▽ floor) 	
ZS XS YS	Coordinates of the start point in X, Y and Z (only with start point "manual")	
Plunging	(only ▽, or ▽ ▽ ▽ bottom) <ul style="list-style-type: none"> vertical: Plunge vertically on pocket center: The calculated current infeed depth will be executed in the pocket center in one block. With this setting the milling cutting tool must cut via the center or it must be pre-drilled. helical: Plunging on spiral path: The center of the milling cutter moves on the spiral path defined by the radius and the depth per revolution (helical path). Once the depth for the infeed has been reached, another full circle will be executed, in order to overcome the angular path of the plunge. swinging: Plunge swinging on the center axis of the longitudinal groove: The center of the milling cutter swings on a straight line back and forth till the depth infeed is reached. Once the depth has been reached, the path will be executed again without the depth infeed, in order to overcome the angular path of the plunge. 	
FZ FX	Infeed depth (only if plunging vertically and if ▽, or ▽ ▽ ▽ floor)	mm/min
EP	Maximum pitch of the helix - (only with helical plunging)	mm/rev
ER	Radius of the helix (only with helical plunging) The radius may not be larger than the milling cutting tool radius, as otherwise material remains.	mm
EW	Maximum plunge angle (only with swinging plunging)	degrees

Parameter	Description	Unit
Lift mode before renewed infeed	<p>Lift mode before renewed infeed: If several plunge points are required during processing, the retraction height can be programmed.</p> <ul style="list-style-type: none"> • on RP • Z0 + safety distance <p>During the transition to the next plunge point the tool pulls back to this height. If there are no elements larger than Z0 in the pocket area, Z0 + safety distance can be programmed as lift mode. (only if ▽, ▽ ▽ ▽ floor, or ▽ ▽ ▽ edge)</p>	mm
FS	Bevel width for chamfering (only for chamfering)	mm
ZFS XFS	Tool tip plunge depth (absolute or incremental) (only if chamfering)	mm



Instructions:

With manual input the start point can also be outside the pocket. This can, for example, be sensible when clearing a pocket that is open at the side. The machining then begins without plunging with a straight line movement into the open side of the pocket.

Contours for pockets or islands

Contours for pockets or islands must be closed, i.e. start and end point of the contour are identical. Pockets can be milled that are contained inside one or more islands. The islands may also be partly outside the pocket or intersect with one another. The first indicated contour will be interpreted as a pocket contour, all the others as islands.

Calculate start point automatically / enter manually

The optimal point for plunging can be calculated automatically using "Start point automatic". "Start point manual" defines the plunge point in the parameter screen. If it emerges from the pocket contour, the islands and the milling cutting tool diameter that there must be plunging at various points, the manual input defines only the first plunge point. The others will be calculated automatically.

Machining

The processing of contour pockets with islands/raw part contour with spigots will be programmed as follows:

Example:

- 1 Enter pocket contour/unmachined part contour
2. Enter island/spigot contour
- 3 Program contour call for pocket contour/raw part contour or island/spigot contour.
- 4 Program centering (only possible with pocket contour)
- 5 Program pre-drilling (only possible with pocket contour)
- 6 Clear/machine pocket/spigot - roughing
- 7 Clear/machine remaining material - roughing.
- 8 Finishing (floor/edge)
- 9 Chamfering



Mill spigot (CYCLE63)

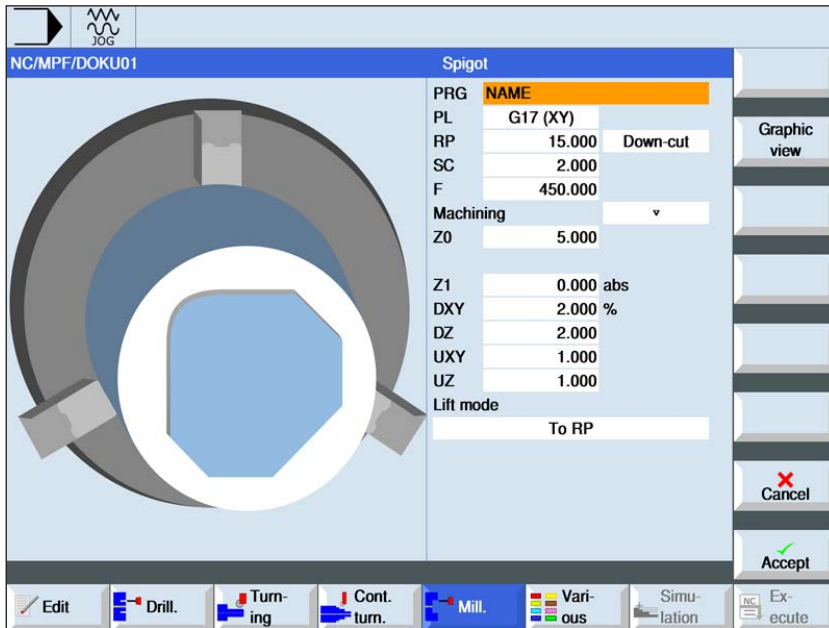

The "Select" button gives you the option to change parameters and/or units. To do this move the cursor to the appropriate field and press button.

Parameter	Description	Unit
PRG	Name for the program to be generated	
PL	Machining plane: • G17 (XY)	
RP	Retract plane	mm
Milling direction	• Up-cut milling • Down-cut milling	
SC	Safety distance	mm
F	Feed	mm/min
Machining	<ul style="list-style-type: none"> • ▾ Roughing • ▾ ▾ Floor finishing • ▾ ▾ ▾ Edge finishing • Chamfering 	
Z0	Reference point Z	mm
Z1	Pocket depth (absolute) or depth relative to Z0 (incremental)	mm
DXY	<ul style="list-style-type: none"> • maximum plane infeed • maximum plane infeed as a percentage of the milling cutting tool diameter (only ▾, or ▾ ▾ ▾ floor) 	mm %

Parameter	Description	Unit
DZ	maximum infeed depth (only if ▽, or ▽ ▽ ▽ edge)	mm
UXY	Finishing pass plane	mm
UZ	Finishing pass depth	mm
Lift mode before renewed infeed	<p>Lift mode before renewed infeed: If several plunge points are required during processing, the retraction height can be programmed.</p> <ul style="list-style-type: none"> • on RP • Z0 + safety distance <p>During the transition to the next plunge point the tool pulls back to this height. If there are no elements larger than Z0 in the pocket area, Z0 + safety distance can be programmed as lift mode. (only if ▽, ▽ ▽ ▽ floor, or ▽ ▽ ▽ edge)</p>	mm
FS	Bevel width for chamfering (only for chamfering)	mm
ZFS	Tool tip plunge depth (absolute or incremental) (only if chamfering)	mm

Contours for pockets or islands

Contours for pockets or islands must be closed, i.e. start and end point of the contour are identical. Pockets can be milled that are contained inside one or more islands. The islands may also be partly outside the pocket or intersect with one another. The first indicated contour will be interpreted as a pocket contour, all the others as islands.

Calculate start point automatically / enter manually

The optimal point for plunging can be calculated automatically using "Start point automatic". "Start point manual" defines the plunge point in the parameter screen. If it emerges from the pocket contour, the islands and the milling cutting tool diameter that there must be plunging at various points, the manual input defines only the first plunge point. The others will be calculated automatically.

Contours for spigots

Contours for spigots must be closed. The start and end point of the contour are identical. Several spigots can be defined that can also intersect with one another. The first indicated contour will be interpreted as a raw part contour, all the others as spigots.

Machining

The processing of contour pockets with islands/raw part contour with spigots will be programmed as follows:

Example:

1. Enter pocket contour/raw part contour
2. Enter island/spigot contour
3. Centering (only possible with pocket contour)
4. Pre-drilling (only possible with pocket contour)
5. Clear/process pocket/spigot - roughing
6. Clear/process remaining material - roughing
7. Finishing (floor/edge)
8. Chamfering

Cycle description**Chip crushing**

- 1** The control system positions the tool in the spindle axis in rapid traverse (G0) to the safety distance above the reference point. DThe start point will be calculated by the cycle.
- 2** The tool first feeds in to the machining depth and then approaches the spigot contour sideways in the quadrant with machining feed.
- 3** The spigot will be cleared in parallel with the contour from outside to in. The direction will be defined by the processing direction of rotation (up-cut milling or down-cut milling).
- 4** Once the spigot in one plane has been cleared, the tool leaves the contour in the quadrant and the infeed to the next machining depth takes place.
- 5** The spigot will again be approached in the quadrant cleared in parallel with the contour from outside to in.
- 6** Steps 4 to 5 will be repeated until the programmed spigot depth is reached.
- 7** The tool moves back to the safety distance in rapid traverse (G0).

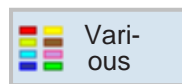

Various

- Unmachined part
- Transformations
- Sub-routine
- Bar loader interface



Unmachined part data

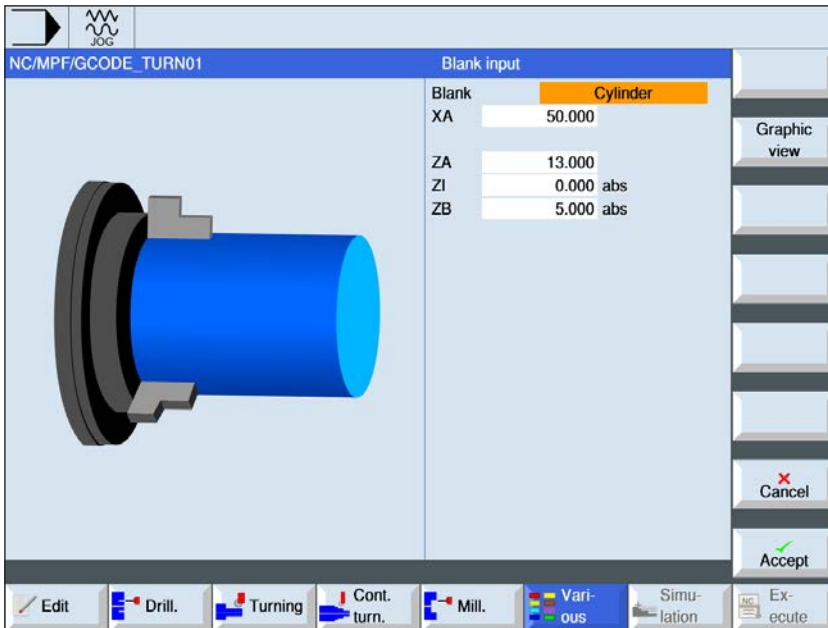

The "Select" button gives you the option to change parameters and/or units. To do this move the cursor to the appropriate field and press button.

Parameter	Description	Unit
Raw part	<ul style="list-style-type: none"> • Cuboid center • Tube • Cylinder • Polygon 	
W	Width of the raw part (only with cuboid center)	mm
L	Edge length (only with polygon)	mm
N	Number of edges (only with polygon)	
SW	Key width (only if N corner is an integer)	
L	Edge length (only with polygon)	
ZA	Start measurement	
ZI	End dimension depth (absolute) or end dimension relative to ZA (incrementally).	
ZB	Machining dimension depth (absolute) or machining dimension relative to ZA (incrementally)	
XA	External diameter (only for tube or cylinder)	mm
XI	Internal diameter (only for tube or cylinder)	mm

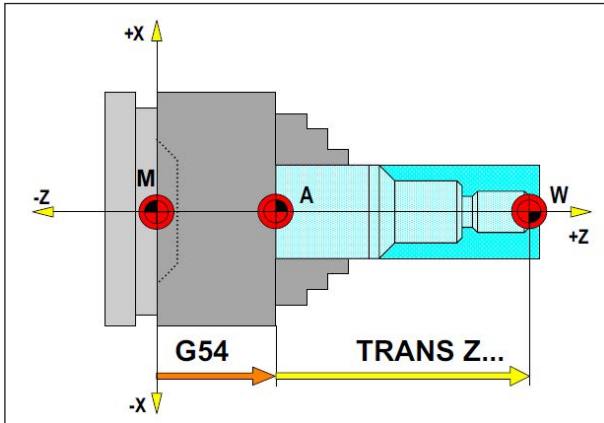

In the following situation the raw part must be described from the stop point A

Raw part definition

When a program with a stop point (e.g. G54) and a transformation (TRANS / ATRANS) is used to machine to the actual workpiece zero point, the raw part definition must be described from the stop point.

M= Machine zero point

A= Stop point

W= Workpiece zero point

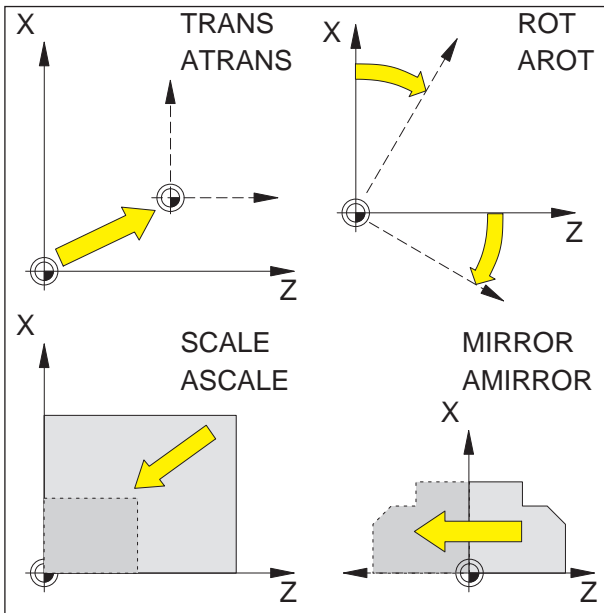

Frames

With Frames the current coordinate system can be changed.

- Shift coordinate system: TRANS, ATRANS
- Rotate coordinate system: ROT, AROT
- Scale or warp coordinate system: SCALE, ASCALE
- Mirror coordinate system: MIRROR, AMIRROR

The Frame instructions are each programmed in their own NC block and executed in the programmed sequence.

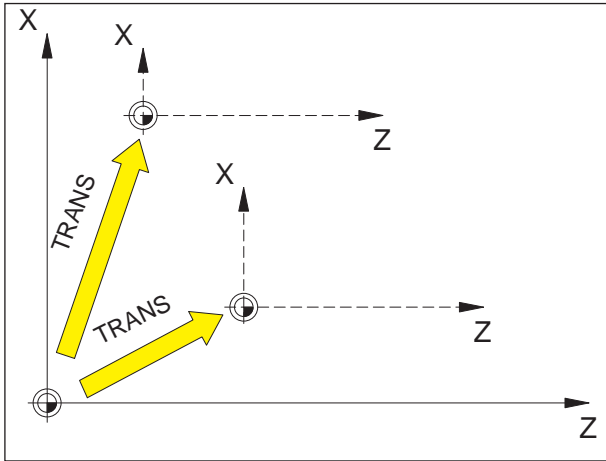

TRANS is always relative to the current zero point G54 - G599.

Zero point offset TRANS, ATRANS

Format:

TRANS/ATRANS X... Z...

TRANS Absolute zero point offset, relative to the current zero point G54-G599. (TRANS deletes all previously set programmable Frames (TRANS, ATRANS, ROT, AROT, ...)).

ATRANS Additive zero point offset, relative to the currently set (G54-G599) or programmable (TRANS/ATRANS) zero point.

You program a shift that builds on the already existing Frames (TRANS, ATRANS, ROT, AROT, ...) with ATRANS.

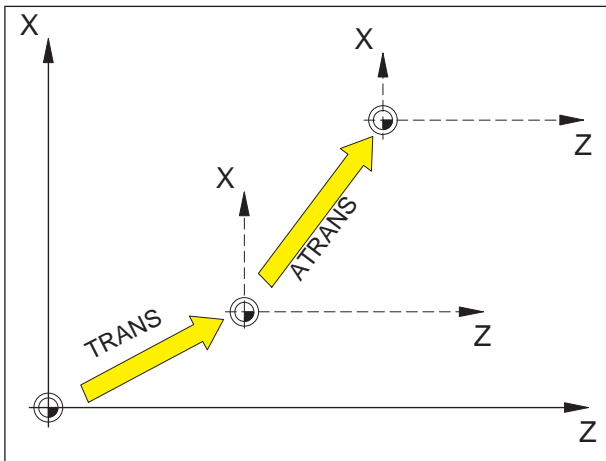

ATRANS is relative to the last valid zero point G54 - G599, TRANS.

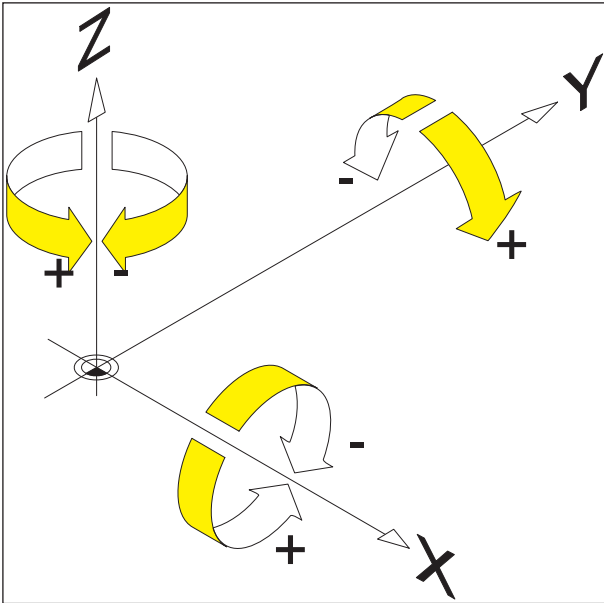

Rotate coordinate system ROT, AROT

With ROT/AROT the coordinate system will be rotated around the geometry axes X, Y, Z or in the current working plane G18.

For contours whose main axes are rotated in relation to the geometry axes, there are programming simplifications.

Format:

ROT/AROT X.. Z..

ROT/AROT RPL=..

ROT Absolute rotation, relative to the current zero point G54-G599.

ROT deletes all previously set programmable Frames (TRANS, ATRANS, ROT, AROT, ...).

AROT Additive rotation, relative to the currently set (G54-G599) or programmable (TRANS/ATRANS) zero point.

You program a rotation that builds on the already existing Frames (TRANS, ATRANS, ROT, AROT, ...) with AROT.

X, Z rotation in space (in degrees); geometry axis around which the rotation will occur.

RPL= Rotation in the current plane (G18) (in degrees).

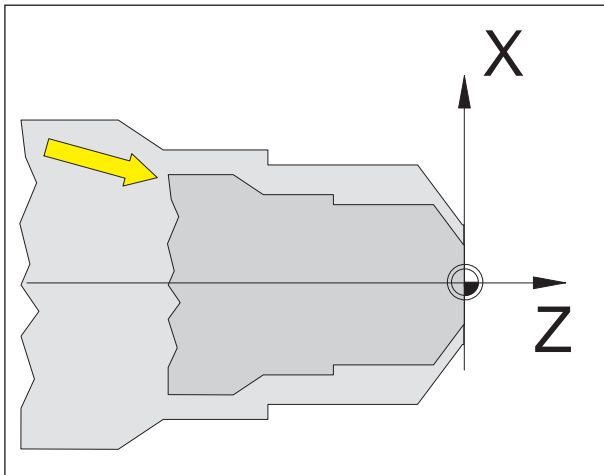

Scale SCALE, ASCALE

With SCALE/ASCALE each axis X, Z will have its own scale factor indicated.

The scale factor in the current work plane must be identical.

Format:

SCALE/ASCALE X.. Z..

If a shift is programmed with ATRANS after SCALE/ASCALE, this shift will also be scaled.

SCALE Absolute scale, relative to the current zero point G54-G599.

SCALE deletes all previously set programmable Frames (TRANS, ATRANS, ROT, AROT, ...).

With SCALE without axis input the mirroring (and all other Frames) will be deselected.

ASCALE Additive scale, relative to the currently set or programmed coordinate system. You program a scale factor change that builds on already existing Frames (TRANS, ATRANS, ROT, AROT, etc.) with ASCALE.

X, Z Scale factor for the relevant axis.

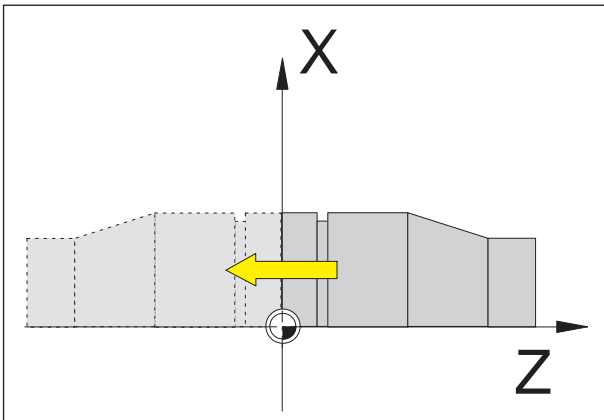

Mirror coordinate system MIRROR, AMIRROR

With MIRROR/AMIRROR the coordinate system will be mirrored around the geometry axes X, Z.

Format:

MIRROR/AMIRROR X.. Z..

If you mirror a contour, the circular direction of rotation G2/G3 and the tool radius correction G41/G42 will be converted automatically.

MIRROR Absolute mirroring, relative to the current zero point G54-G599.

MIRROR deletes all previously set programmable Frames (TRANS, ATRANS, ROT, AROT, ...).

With MIRROR without axis input the mirroring (and all other Frames) will be deselected.

AMIRROR Additive mirroring, relative to the currently set or programmed coordinate system.

You program a mirroring that builds on the already existing Frames (TRANS, ATRANS, ROT, AROT, ...) with AMIRROR.

X, Z Geometry axis data, about which is the mirroring. The value given here is freely selectable, e.g. X0, Z0

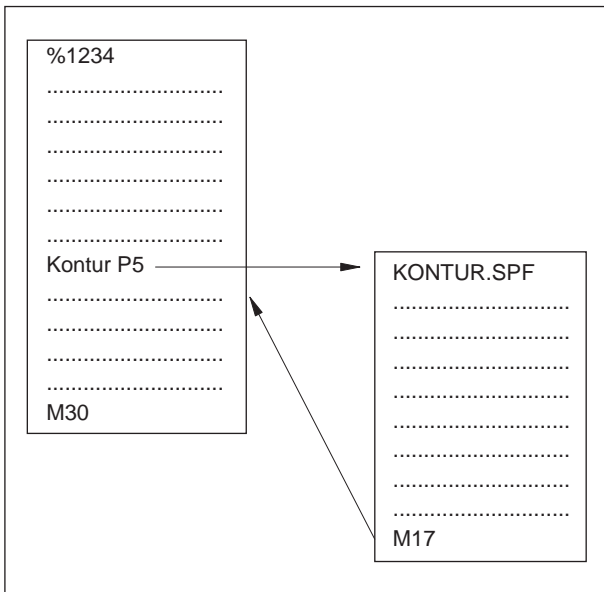

Program run with a sub-program

Sub-routines

Functional sequences to be repeated several times can be entered as sub-programs.

The sub-programs are invoked by name.

R-parameters can be passed to sub-programs.

Sub-routine end with M17

e.g.: N150 M17

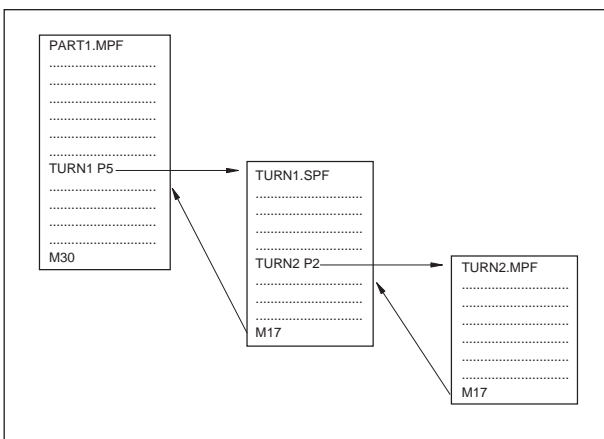

Nesting sub-programs

Sub-routine nesting

Sub-routines can be stacked 30-fold. The automatic block pre-run is possible up to the eleventh sub-program level.

Cycles also count like sub-programs, i.e. for example a drilling cycle can be called from the 29th sub-routine plane.

Instructions:
 Sub-routine calls must always be programmed in their own NC blocks.



Sub-routines with passing of parameters

Program start, PROC

A sub-program that when the program is running should be passed parameters from the calling program, will be identified with the keyword PROC.

Program end M17, RET

The command M17 identifies the sub-program end and the jump back to the main program. The command RET represents the sub-program end without interrupting the path control operation.

Sub-routine program with SAVE mechanism

This function saves current settings (operating data) when the sub-program is called. Upon return to the old program the old state is re-established automatically.

For this in the programming the command SAVE must be programmed in addition to PROC.

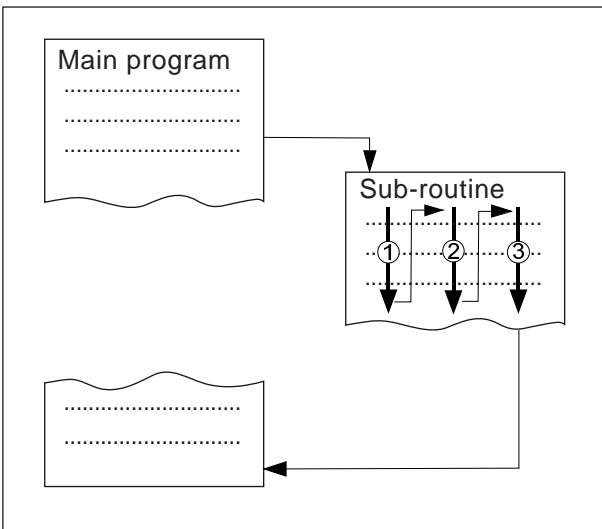

Sub-routine with program repetition, P

If a program should be executed several times in succession, the desired number of program repetitions can be programmed in address P in the block of the sub-program call.

Parameters will only be changed when the program is called. For later repetitions the parameters remain unchanged.

Sub-routine call in parts program

e.g.: TURN1 P1
 TURN1 Sub-routine number
 P1 Number of sub-routine cycles
 (max. 99)

Instructions:
 Only one MCALL call can be active at the same time in a program run. Parameters are only passed once in an MCALL call

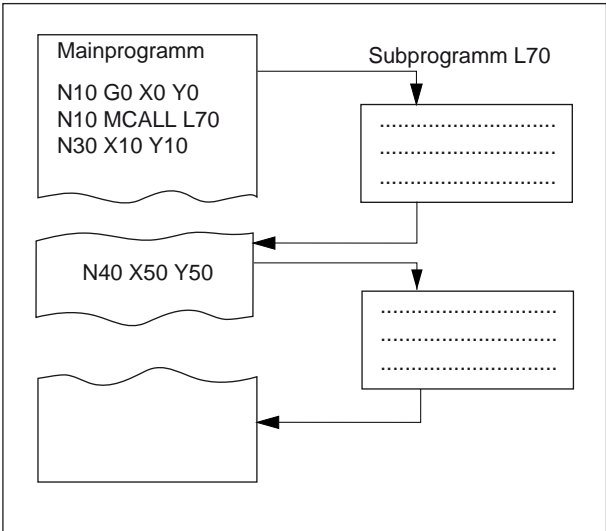

Modal sub-program MCALL

With this function the sub-program will be called automatically and executed after every block with path movement. For this reason the calling of sub-programs that can be executed in different workpiece positions may be automated. For example to create hole patterns.

Example

```
N10 G0 X0 Y0
N20 MCALL L70
N30 X10 Y10
N40 X50 Y50
```

Switch off modal sub-program calling

With MCALL without sub-program call or by programming a new modal sub-program call for a new sub-program.



Call up sub-routine

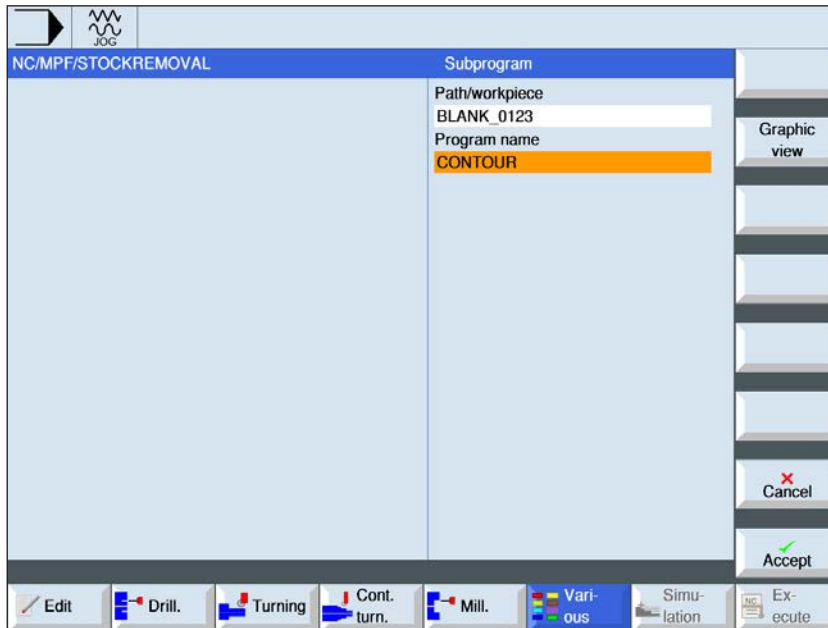

If the desired sub-program is not in the same directory as the main program, the sub-program's path must be indicated.

Parameter	Description
Path/workpiece	Sub-routine's path, if the desired sub-program is not in the same directory as the main program.
Program name	Name of the sub-program that should be inserted.

If the same processing steps are required when programming various workpieces, these processing steps can be defined as a separate sub-program. This sub-program can then be invoked in arbitrary programs. This prevents the need to program the same processing steps multiple times. The control system does not distinguish between main programs and sub-programs. This means that a "normal" work step or G-code program can be called in another work step program as a sub-program. In turn, a sub-program can be called from the sub-program.

It should be noted that the ShopTurn sub-routine analyzes the settings from the sub-routine program header when called up. These settings also remain effective once the sub-program has finished. If you want to reactivate the settings from the program header of the main program, you can perform the desired settings in the main program after calling the sub-program.

The sub-program must be stored in its own directory "XYZ" or in the directories "Part programs", "Sub-routines".

Program jumps

Unconditional program jumps

Format

Label:

GOTO LABEL

or

GOTOB LABEL

or

GOTOF LABEL

Label:

GOTO Jump instruction only forwards then backwards (direction only for program stop and then program start)

GOTOB Jump instruction with reverse jump target (in the direction of the program start)

GOTOF Jump instruction with forward jump target (in the direction of the program end)

LABEL Target (marking inside a program)

LABEL: Jump target

Instructions:

The unconditional / conditional jump must always be programmed in its own NC block.



The sequence of programs operating as standard (main program, sub-program, cycles, etc.) can be changed by program jumps. Jump targets can be approached within a program using GOTOF or GOTOB.

The program continues execution with the instruction that directly follows the jump target.

Conditional program jump

Format:

Label:

IF expression GOTO LABEL

or

IF expression GOTOB LABEL

or

IF expression GOTOF LABEL

LABEL:

IF Conditions

GOTO Jump instruction only forwards then backwards (direction only to program stop and then to program start)

GOTOB Jump instruction with reverse jump target (in the direction of the program start)

GOTOF Jump instruction with forward jump target (in the direction of the program end)

LABEL Target (marking inside a program)

LABEL: Jump target

Jump conditions can be formulated using the IF instruction. The jump to the jump target only takes place if the condition was fulfilled.

Programming messages MSG

Messages can be programmed to give the operator information about the current processing situation during program execution.

A message will be generated in an NC program by writing the keyword "MSG" in round brackets "()" and the message text inside quote marks.

A message can be deleted with "MSG()".



Instructions:

A message text may consist of a maximum of 130 characters and will be shown in 2 lines (2x 65 characters).

Example:

```
N10 MSG ("Contour roughing")
```

```
N20 X... Y...
```

```
N ...
```

```
N90 MSG ()
```

Alongside messages, alarms can also be set in an NC program. These will be shown in the screen display in a separate field. An alarm is always associated with a reaction from the control system, according to the alarm category.

Alarms are programmed by writing the keyword "SETAL" in round brackets following the alarm number. Alarms must always be programmed in a single block.

Example:

```
N100 SETAL (65000)..... ; Set alarm 65000
```

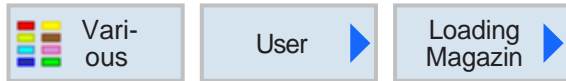

Bar Loading Interface



The "Select" button gives you the option to change parameters and/or units. To do this move the cursor to the appropriate field and press button.

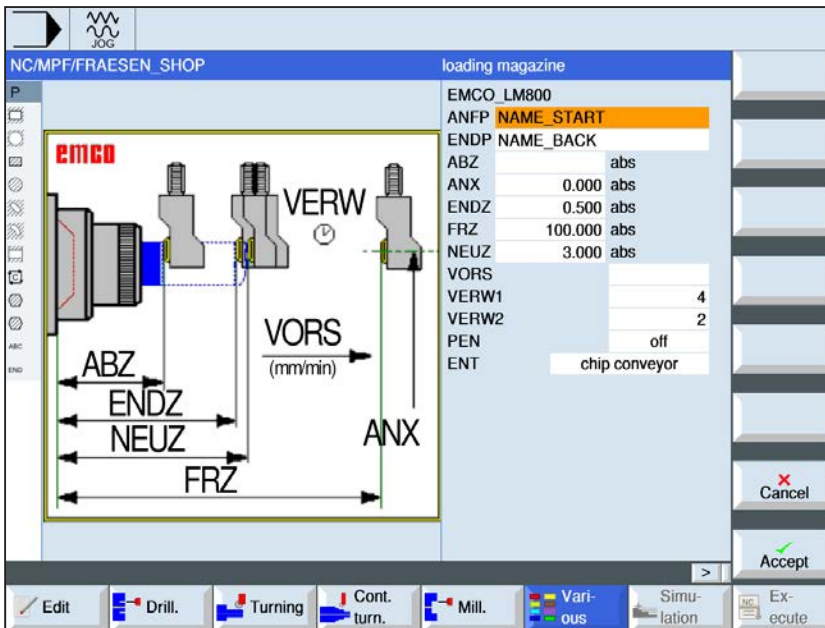

Parameter	Description	Unit
ANFP	Name of bar beginning program	
ENDP	Name remnant machining program	
ABZ	Stop pos. before bar feed in Z (absolute)	mm
ANX	Stop position in X (absolute)	mm
ENDZ	Stop pos. after bar feed in Z (absolute)	mm
FRZ	Release pos. of stop for remnant disposal (absolute)	mm
NEUZ	Stop pos. after feed new bar (absolute)	mm
VORS	Bar feed in [mm/min] with stop	mm/min
VERW1	Dwell time part catcher forward	s
VERW2	Dwell time for remnant disposal	s
PEN	Selection oscillation of the main spindle: • off • on	
ENT	Selection of the remnant disposal: • chip conveyor • parts catcher • remnant program	

Note:

The option bar loading interface is only available for those machines which can be equipped with a bar loading interface.



C-axis

To mill surfaces (quadrant, sextant etc.) the C-axis and the tool slots must be moved in a certain ratio to each other (=roll-off milling).

The "TMCON" ancillary software programs these surfaces with ease.

For description with programming example, see "Transmit" section.

Switch on and position the C-axis only when the main spindle is stationary

SPOS[1]=0	Enable C-axis and set to 0°
G0 C90	Set C-axis to 90°

Deselect C-axis

M3, M4, M5

C-axes in JOG mode

So that the C-axes can be operated in JOG mode, the following program must be run beforehand in MDA mode:

Main spindle	
SPOS[1]=0	(Enable C-axis and set to 0)

Set spindles SPOS, SPOSA

Instructions:

Spindle positioning commands must always be in a separate NC record.



SPOS=... or SPOS [n]=
SPOSA=... or SPOSA [n]=
WAITS or WAITS (n,n,n)

SPOS/SPOS[n]... Set master spindle or spindle n. NC record is only forwarded after setting.

SPOSA/SPOSA[n] Set master spindle or spindle n. NC record is also forwarded if the position is not reached.

WAITS/WAITS(n,n,n) Wait for the spindle to reach its position. WAITS applies for the master spindle, otherwise for the given spindles.

Use SPOS and SPOSA to set spindles to defined angles, e.g. for tool change. The spindle can also be moved under its defined address in the machine datum as a path axis.

Instructions:

If M3 or M4 are switched on, the spindle comes to a standstill in the programmed value.



Synchronize spindle movement:

WAITS, WAITS (n,n,n)

Use WAITS to mark a point in the NC program, at which there is a wait until one more spindles programmed in an earlier NC record have reached their positions.

Ex.: N10 SPOSA [2] =180 SPOSA [1]=0
N20...N30
N40 WAITS (1,2)

The dwell time in the record is until spindle 2 and spindle 1 have reached the positions given in record N10.

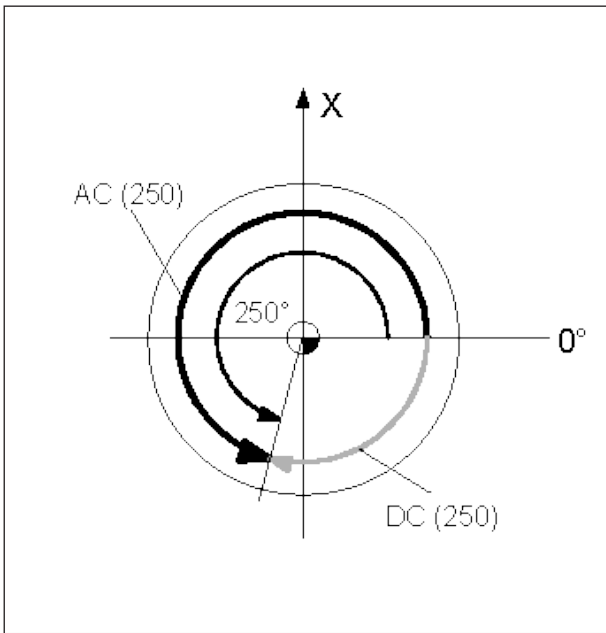

 Instructions:
 SPOS and SPOSA act only until next M3, M4, M5.
 If instead of SPOS the spindle is switched off with SPCON, this must be switched on again with SPCOF.

Give spindle position:

The spindle position is given in degrees. Because the G90/G91 commands do not work here, the following explicit data applies:

- AC(...) Absolute dimension data
- IC(...)..... Incremental dimension data
- DC(...) Approach direct path at absolute value.
- ACN(...)..... Absolute dimension data, Approach in negative direction.
- ACP(...)..... Absolute dimension data, Approach in positive direction.

Ex.: N10 SPOSA [2] =ACN (250)

Spindle 2 should be set to 250° with negative rotation.

Without data, movement is automatically as for DC data. 2 spindle position statements are possible per NC record.

- SPCON Toggle master spindle or spindle(s) from speed control to position control
- SPCOF Toggle master spindle or spindle(s) from position control to speed control

Extended addressing for spindle speed S and spindle rotations M3, M4, M5, SETMS

Spindle 1 = master spindle (= switched on state)

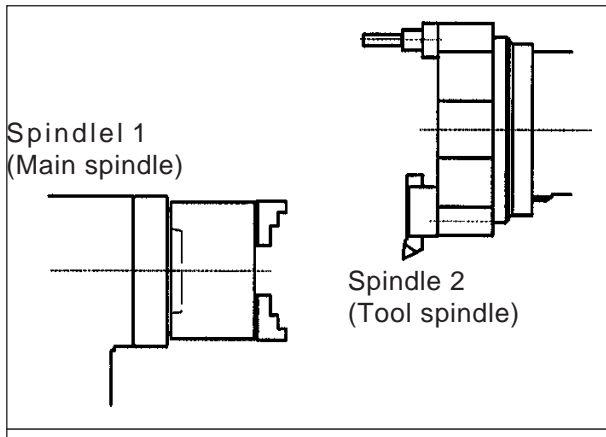

- S...M3 Main spindle right, speed S...
- S...M4 Main spindle left, speed S...
- M5 Main spindle stopped
- S2=...M2=3 Tool spindle right, speed S...
- S2=...M2=4 Tool spindle left, speed S...
- M2=5 Tool spindle stopped

Spindle 2 = master spindle

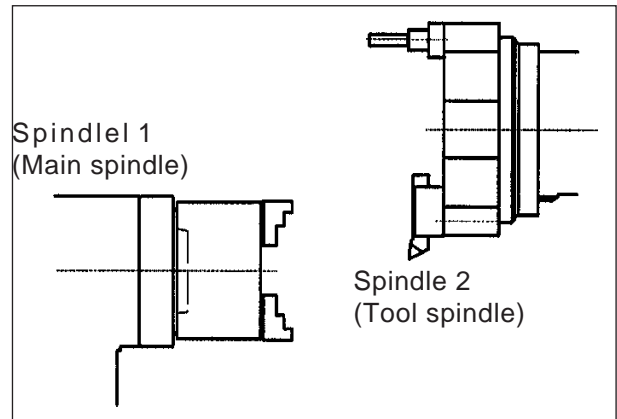

- S1=...M1=3 Main spindle right, speed S...
- S1=...M1=4 Main spindle left, speed S...
- M1=5 Main spindle stopped
- S...M3 Tool spindle right, speed S...
- S...M4 Tool spindle left, speed S...
- M5 Tool spindle stopped
- SETMS(2) Spindle 2 becomes master spindle
- SETMS Reset to switched on state

Example 1

The main spindle remains the master spindle:
The address (spindle number) for the driven tools must also be programmed.

```
S3000 M3      Main spindle on
T1 D1        Tool T1
G94 S2=1000 M2=3  Speed for AWZ
```



Only G94(mm/min) possible.
For G95(mm/rev) the feed would be related to the speed of the master spindle (=main spindle)

Example 2

The tool spindle is set for master spindle:
The driven tools are programmed as main spindles.

```
T1 D1      Tool T1 tool correction
SETMS(2)  Spindle 2 becomes master spindle
SPOS[1]=0  Enable C-axis
```

```
G95 S5000 M3  Speed for driven tool
```

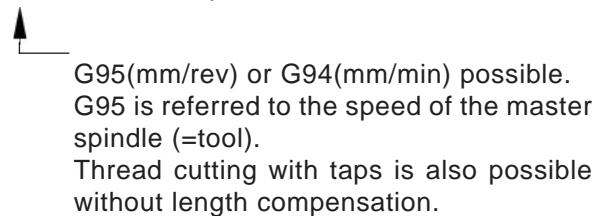

TRANSMIT - Cycle

TRANSMIT → **TRANS**form - Milling Into Turning

With Transmit you can programm any contours at the face of the part.

For cycles without support:

On the plane face of the turned part a Cartesian coordinate system is set with the X axis being a linear axis and the Y axis a theoretical one. The movement at the Y axis is converted into a synchronous movement in the X axis with the C axis.

Activation:

Main spindle **TMCON**

Deactivation (generally).....**TMCOFF**

Prior to the selection of TMCON there must be no traverse movement.



Notes:

- With the programming of TMCON automatically the right spindle will be activated as master-spindle.
The C-axis will be positioned at "0".
- You can use TRANSMIT with or without programming support.

Programming functions without cycle support

Face milling TRANSMIT

Example - hexagon ks30

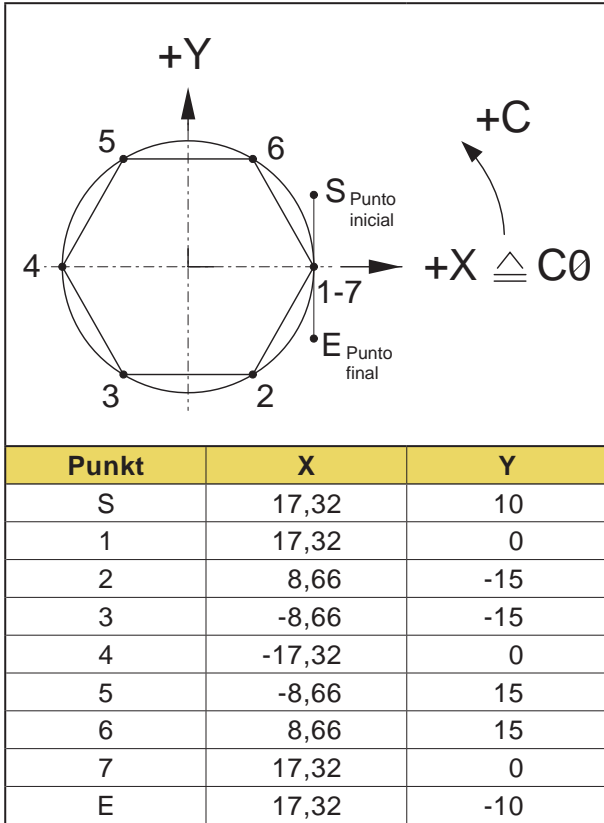

```
G54
G53 G0 X... Z... (Z2=...)
N1 T1 D1 ;axial end-mill cutter ø10
TMCON ;selection plane G17 for TRANSMIT at the main spindle
G95 S950 M4 F0,1 ;direction of rotation of tool dependent on toolholder!
G41 G0 X17.32 Y10 Z2 ; start point
G0 Z-2
G1 Y0 F0.12 ; point 1
X8.66 Y-15 ; point 2
X-8.66; ; point 3
X-17.32 Y0 ; point 4
X-8.66 Y15 ; point 5
X8.66 ; ; point 6
X17.32 Y0 ; point 7
Y-10 ; ; end point
G40 G0 X150 Z10 M5
TMCOFF ;reset to plane G18 by deselection of TRANSMIT
SETMS(1) ;possibly reset of the main spindle as master spindle
M30
```

Example - hexagon ks30 with polar coordinate interpolation

```
G54
G53 G0 X... Z... (Z2=...)
N1 T1 D1 ;end mill cutter dia 10
TMCON ;selection plane G17 for TRANSMIT at the main spindle
G95 S950 M4 F0,1 ;direction of rotation of tool dependent on toolholder!
G111 X0 Y0 ;set pole, absolutely in G54
G41 G0 AP=20 RP=20 ;AP=Polar angle, RP=Polar radius
G1 AP=0 RP=17.32;Area 1
AP=IC(-60) ;Area 2
AP=IC(-60) ;Area 3
AP=IC(-60) ;Area 4
AP=IC(-60) ;Area 5
AP=IC(-60) ;Area 6
G40 G0 AP=0 RP=30
Z10 M5
TMCOFF ;reset to plane G18 by deselection of TRANSMIT
SETMS(1) ;possibly reset of the main spindle as master spindle
M30
```

Notes:

- The coordinates X0/Y0 may not be programmed, because in this position it isn't possible to calculate a value for the C-axis.
- TMCOFF has to be programmed before tool changing.



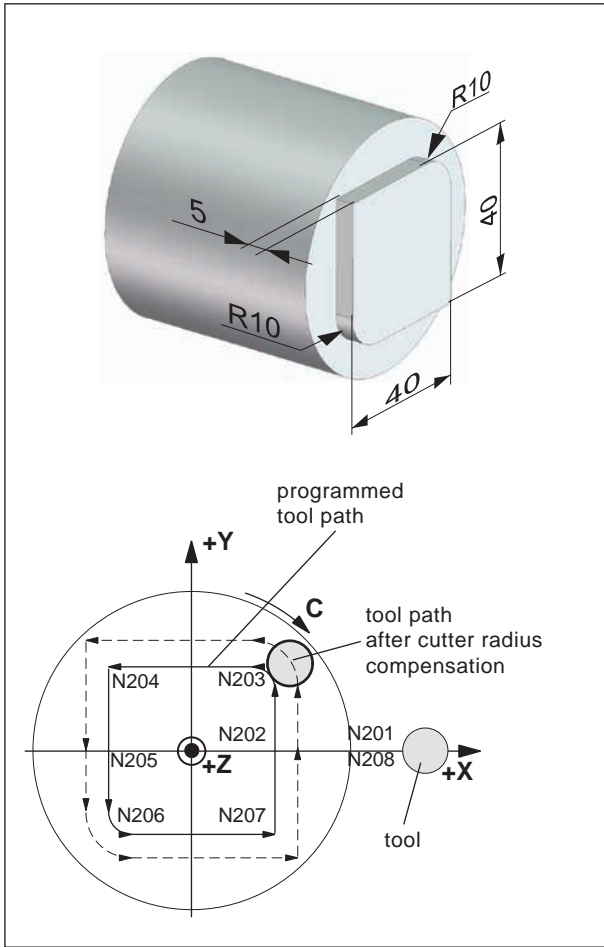

Example - Contour milling

```

G54
G53 G0 X... Z... (Z2=...)
N1 T1 D1 ;end mill cutter dia 10
TMCON ;selection plane G17 for TRANS-
MIT at the main spindle
G95 S950 M4 F0,1 ;direction of rotation of tool de-
pendent on toolholder!
N200 G42 G0 X40 Z5
G0 Z-5
N201 G1 X20
N202 Y10
N203 G3 X10 Y20 CR=10
N204 G1 X-20
N205 Y-10
N206 G3 X-10 Y-20 I10 J0
N207 G1 X20
N208 Y0
N209 X60
Y-10 ;end point
G40 G0 X120 Z10 M5
TMCOFF ;reset to plane G18 by deselection
of TRANSMIT
SETMS(1) ;possibly reset of the main spindle
as master spindle
M30
    
```

Cylinder interpolation TRACYL

TRACYL → TRANSform - CYLinder

TRACYL is used for contour milling at the cylinder surface. Therefore a surface of cylinder is transformed into a plane surface (surface development).

Selection:
main spindle TRCON(øsurface of cylinder)

Deselection:
general TMCOFF

Before the selection of TRCON there must be no traverse movement.

- Notes:**
- With the programming of TRCON automatically the right spindle will be activated as master-spindle.
 - TMCOFF has to be programmed before tool changing.

Example - Contour milling

```
G54
G53 G0 D0 X... Z... (Z2=...)
N1 T3 D1 ;radial driven tool,
end-mill cutter ø2
TRCON(30) ;activation of TRACYL at the main
spindle, workpiece ø30
G95 S1000 M3 ;sense of rotation of tool depen-
dent on toolholder!

G0 Y-1.5 Z-31.5
G1 X29 F0.08
G42 Y-1.5 Z-33
Y-20
G2 Y-20 Z-13 CR=10
G1 Y-6.5
G2 Y-6.5 Z-16 CR=1.5
Y-20
G3 Y-20 Z-30 CR=7
G1 Y0
Z-33
G40 Y-1.5 Z-31.5
G0 X32 Z2
TMCOFF ;deselection TRACYL
G0 X150 Z150 M5
SETMS(1) ;possibly reset of the main spindle
as master spindle

M30
```

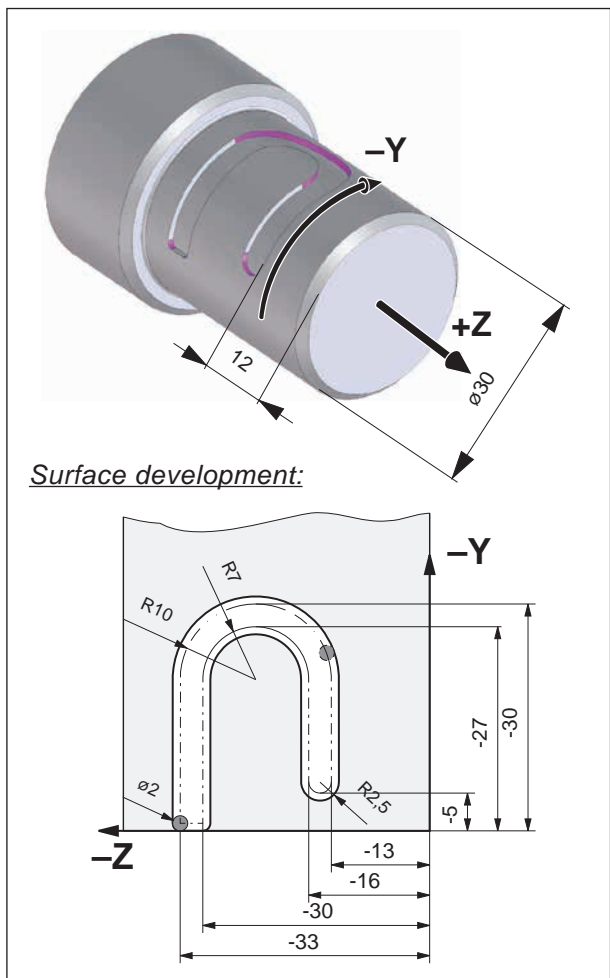

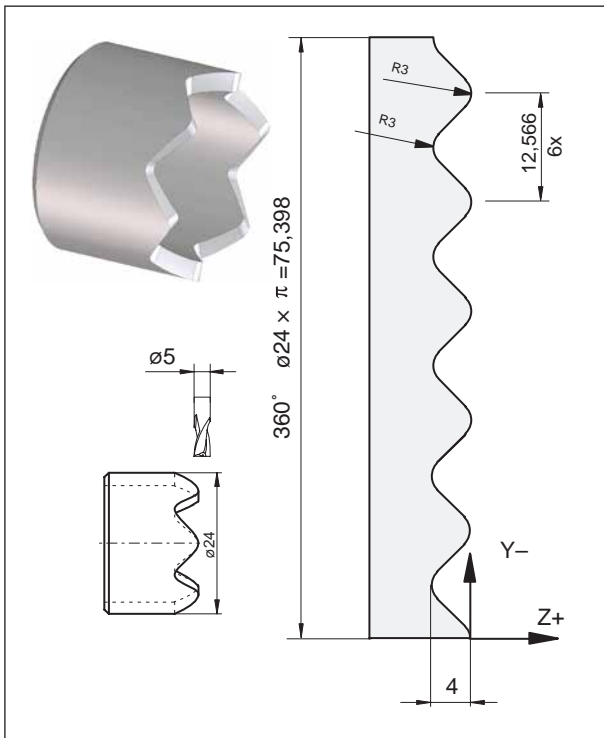

Example - Cam milling

```

G54
G53 G0 D0 X... Z... (Z2=...)
N1 T1 D1 ;radial driven tool, end-mill cutter
           ;ø5
TRCON(24) ;activation of TRACYL at the main
           ;spindle, workpiece ø24
G95 S1000 M3 ;sense of rotation of tool depen-
           ;dent on toolholder!

G42 G0 Y0 Z1
G1 Z0 F0.06
MARK1:
G91 G3 Y-2.224 Z-0.987 CR=3
G1 Y-4.059 Z-3.013
G2 Y-6.283 Z-3.013 CR=3
G1 Y8.507 Z-0.987
G3 Y-12.566 Z0 CR=3
ATRANS Y-12.566
MARK2:

REPEAT MARK1 MARK2 P5
           ;program part between jump inst-
           ;truction 1 and 2; repeat 5 times

G90 G40 G0 Z10
TMCOFF ;deselection TRACYL
G0 X150 Z150 M5
SETMS(1) ;possibly reset of the counter
           ;spindle as master spindle

M30
    
```

CFTCP, CFC, CFIN feed optimization

Default setting (CFC):

If tool radius compensation G41/42 is selected, the feed is related to the programmed contour.

With the default setting CFC, high or low feeds can occur if there are curvatures on the side of the contour away from the tool.

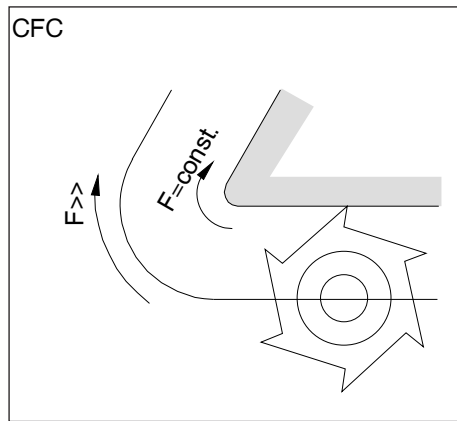

Tool outside the curvature

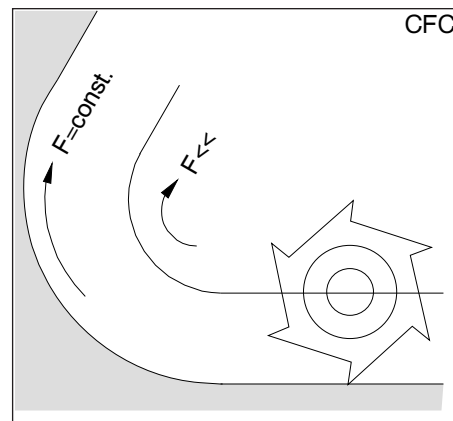

Tool inside the curvature

The feed pattern is determined with the following commands:

CFTCP

(Constant Feed in Tool Centre Point)

Constant feed in mill center point path.

The run of the contour does not affect the feed on the mill center point path.

Application:

Mill cuts to full diameter.

(e.g. roughing)

CFC

(Constant Feed at Contour)

Default setting.

Constant feed at the curvature.

The feed speed of the mill center path is increased if the tool is outside the curvature and reduced if the tool is inside the curvature.

Application:

Mill cuts only on the contour.

(e.g. finishing)

CFIN

(Constant Feed at Internal radius)

The feed speed is reduced if the tool is inside the curvature.

The feed speed is not increased on outside curves (important for executing from the full, front finishing, etc.).

F: Tool programming

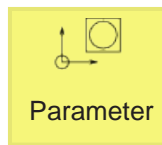

Tool management

All the tool data, the tool wear and the magazine places are shown here.

All lists show the same tools sorted in the same way. When switching between the lists the cursor remains on the same tool in the same image extract.

The lists differ in the parameters shown and the configuration of the softkey.

The following lists are available for selection:

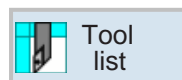

- Tool list
Here all parameters and functions for creating and setting up tools are shown.

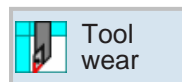

- Tool wear
All parameters and functions required during ongoing operations, e.g. wear and monitoring functions, are shown here.



- Magazine
This contains the parameters and functions related to the magazine or magazine place concerning the tools/magazine places.

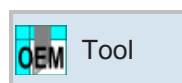

- OEM tool
You can store extra adapter lengths for X, Z here in a user-specific manner.

Symbol		Description
Tool type		
Red cross	✘	The tool is blocked from use. Block is selected in the tool wear in the "G" column.
Yellow triangle - Tip upwards	△	The tool is in a special state. Move cursor on to the identified tool. A tooltip gives a short description.
Green frame	□	The tool is pre-selected.
Magazine/place number		
Green double-arrow	↔	The magazine place is currently on the tool change point (loading position).
Red cross	✘	The magazine place is blocked. Block is selected in the magazine in the "G" column.

A light blue rectangular button with the text "Sort" and a blue right-pointing arrow.

Sorting function

When working with many tools with large magazines, or several, it can be helpful to show the tools sorted according to different criteria. This allows specific tools to be found in the list more quickly.

The following sorting functions are available for selection:

A light blue rectangular button with the text "Acc.to magazine".

- Sort according to magazine
This softkey sorts all tools by magazine place, with the remaining tools that are in the pool being sorted by their type.

A light blue rectangular button with the text "Acc.to name".

- Sort according to name
This softkey sorts all tools according to their names.

A light blue rectangular button with the text "Acc.to type".

- Sort according to type
This softkey sorts all tools according to their type.

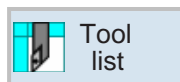
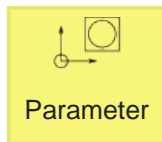

Tool list

The tool list shows all parameters and functions required to create and set up tools. Each tool is identified uniquely by the tool name.





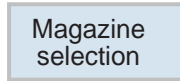

Loc.	Type	Tool name	D	Length X	Length Z	Radius		Loc. leng	Tool measure
1		ROUGHING_TOOL	1	0.000	0.000	0.000	93.0 ←	55	0.0
2		FINISHING_TOOL	1	0.000	0.000	0.000	93.0 →	55	0.0
3		PLUNGE CUTTER	1	0.000	0.000	0.000	0.000		0.0
4		THREADING_TOOL	1	0.000	0.000	0.000			
5		ROTARY_DRILL	1	0.000	0.000	0.000	0.000		
6									
7									
8									
9									
10									
11									
12		CUTTER	1	0.000	0.000	0.000		0	
		DRILL	1	0.000	0.000	0.000	0.0		
		TAP	1	0.000	0.000	0.000	0.000		
		STOP	1	0.000	0.000	0.000			

The tools with place numbers are assigned to the respective magazine places. Tools without place numbers are located in the tool pool below the consecutively numbered magazine places.



The softkey switches quickly between magazine place and tool pool.

Machine	Description
Place	Place number in magazine
Type	The <SELECT> button gives you the option to change tool position or tool type.
Tool name	The tool is identified by the name. The tool name can be entered as text or number.
D	Cutting number
Length X, length Z	Tool length Geometric data for length X and length Z
Radius	Tool radius
∅	Tool diameter

Machine	Description
Width/ Plate width/ Tip angle/  Pitch/ Drilling radius/	Cutting width with type 150 disk milling cutter Plate width with type 520 groover Tip angle with type 200 - spiral drill Cutting graphics: The cutting graphics repeat the positioning defined by holder angle and cutting direction. Pitch for type 240 - thread tap Drilling radius for type 560 - rotary drill. Holder angle and plate angle are fixed.
N/holder angle reference direction	Number of teeth
	Holder angle for type 500 - rougher and type 510 – finisher. The reference direction for the holder angle gives the cutting direction. Besides the holder angle, the plate angle is given as well. The reference direction for the holder angle is selected with the Select button.
Plate length	Plate length of a cutting tool or groover The plate length is needed for representing tools with program execution simulation.
	Spindle direction of rotation <ul style="list-style-type: none"> •  Spindle rotates right •  Spindle rotates left •  Spindle is switched off The direction in which the spindle rotates can be selected with the Select button.
	Coolant 1 and 2 can be switched on and off.

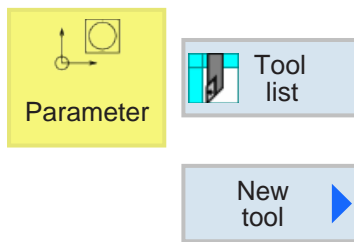

New tool		
Type	Identifier	Tool position
500	- Roughing tool	◀ [4 icons] ▶
510	- Finishing tool	◀ [4 icons] ▶
520	- Plunge cutter	◀ [4 icons] ▶
540	- Threading tool	◀ [4 icons] ▶
550	- Button tool	[4 icons]
560	- Rotary drill	[4 icons]
580	- 3D turning probe	[4 icons]
730	- Stop	[4 icons]
110	- Ball nose end mill	[4 icons]
120	- End mill	[4 icons]
140	- Facing tool	[4 icons]
145	- Thread cutter	[4 icons]
150	- Side mill	[4 icons]
200	- Twist drill	[4 icons]
240	- Tap	[4 icons]

Available tool types

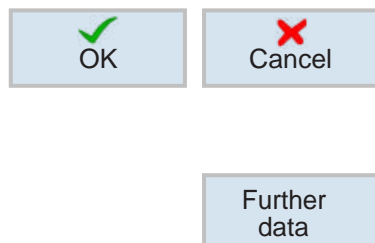

Create new tool

- 1 Position cursor on an empty magazine place or on a free line below the tool places.
- 2 Press softkey.
- 3 With the cursor at the desired tool position, select the desired tool from the list.

- 4 Confirm or cancel tool type selection with softkey.
- 5 **Define** unambiguous tool name (e.g.: Rougher 2).
- 6 When working with the surface mill, use the Further Data softkey to define the \emptyset , external radius and tool angle.

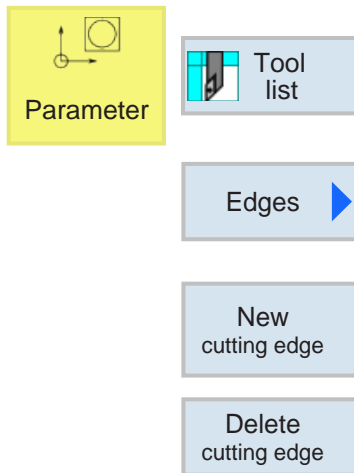

Create/Delete tool blades

- 1 Position cursor on the tool for which a blade should be created.
- 2 Press softkey.
- 3 Press softkey. The new blade will be stored with consecutive numbering below the tool.
- 4 To delete blades position the cursor on the blade and press softkey.

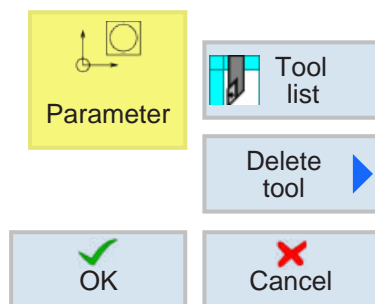

Delete tool

- 1 Position cursor on tool that should be deleted.
- 2 Press softkey.
- 3 Confirm or cancel deletion process with softkey.

Instructions:

If a tool is deleted, all associated blades will be deleted at the same time!



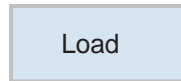

Load tool

Tools will be loaded or unloaded virtually from the tool pool of the tool list into or from the magazine.

- 1 Position cursor on an already created tool in the tool pool. The tool pool is in the tool list below the consecutively numbered magazine places.
- 3 Press softkey. An already loaded and thus occupied magazine place must first be unloaded before reloading.
- 4 The previously loaded tool list will be shown in the tool list on the selected place.

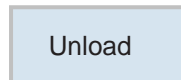

Unload the tool

During unloading the tool will be removed from the magazine and placed in the tool pool below the consecutively numbered magazine places.

- 1 Position cursor on the tool to be unloaded in the spindle or on the magazine place.
- 2 Press softkey.
- 3 The tool remains on the tool place physically and can be removed from there.
- 4 The tool's tool data will be transferred to the tool pool and will not be lost. If the tool is used again later, simply fit and load the tool again in the corresponding magazine place. This avoids the needs to create the tool data again. However, the tool data in the tool pool can be deleted at any time.

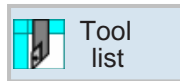
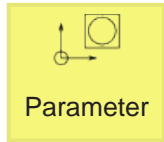

3D tool

3D tools from the tool manager can be imported into the tool list. An independent color assignment for the individual tools can be made.

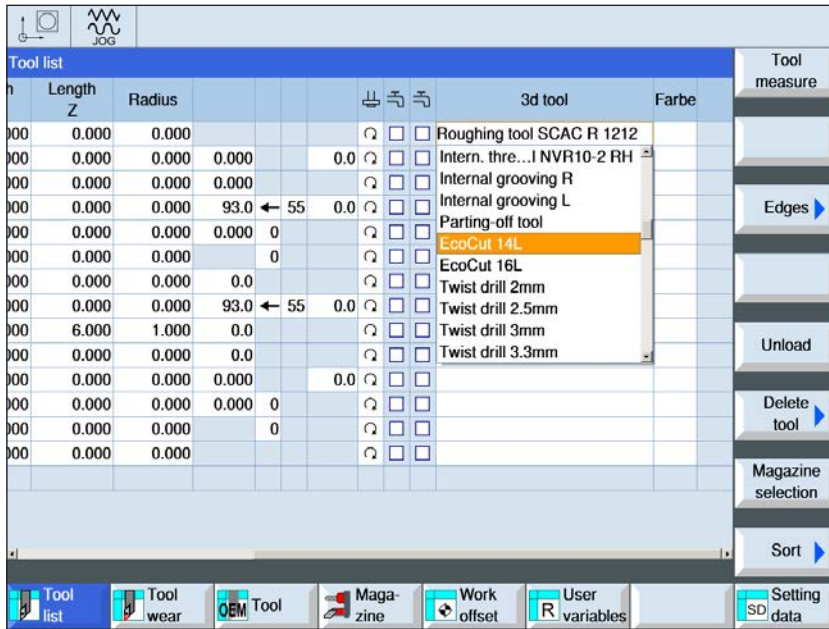

- 1 Move the scroll bar to the right to display the 3D tools.
- 2 Double-click the 3D tool to activate the tool selection (drop down menu). Press the space bar to scroll in the tool selection.
- 3 To deactivate a tool, the blank line (at the very top) must be selected in the drop down menu.



Color select

Colors can be assigned to tools in order to display them better in the simulation.

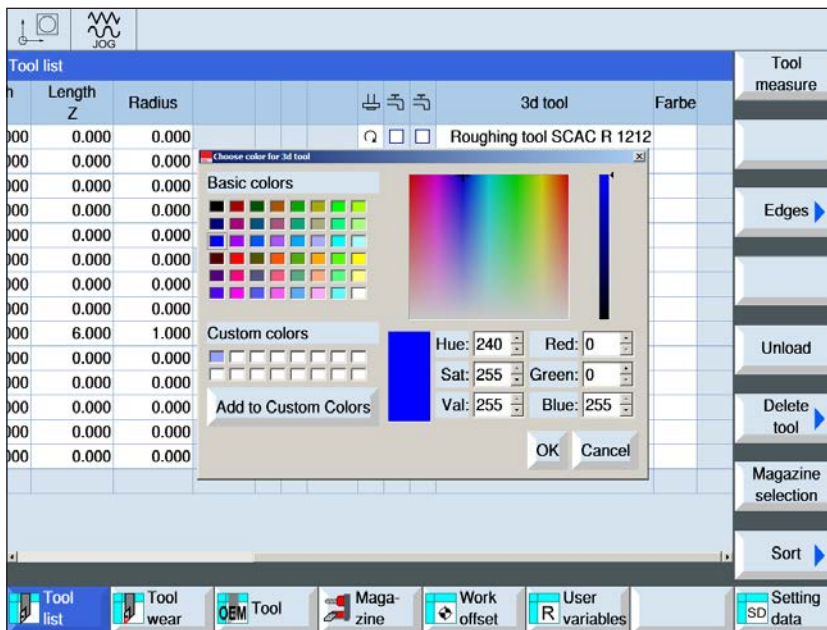

- 1 Move the scroll bar to the right to display the Color selection.
- 2 Double-click the color selection (alternatively use the space bar) to open the color selection window.
- 3 Predefined colors are stored as basic colors, user defined colors as custom colors.
 - Create Custom colors:
Move the mouse in the colored area to the required color and click to select. Alternatively the values for R,G,B can be entered manually.
 - By clicking "Add to Custom Colors" a new color is added.
- 4 To deselect a color, select black.
- 5 Confirm with OK or quit with Cancel.

Instructions:
If no color is selected, it is taken over from the 3D tool manager. Otherwise a selected color has priority.





Tool wear

Tools wear out when they are in use for a long time. This wear can be measured and recorded in the tool wear list. The control system then takes this data into account when calculating the tool length or radius correction. This ensures that the precision remains even during tool processing.

The tool's working life can be monitored automatically via piece count, shutdown time or wear. If tools should no longer be used, they can be blocked (Column "G").

Loc.	Type	Tool name	D	ΔLength X	ΔLength Z	ΔRadius	D
1	ROUGHING_TOOL		1	0.000	0.000	0.000	<input checked="" type="checkbox"/>
2	FINISHING_TOOL		1	0.000	0.000	0.000	<input type="checkbox"/>
3	PLUNGE CUTTER		1	0.000	0.000	0.000	<input type="checkbox"/>
4	THREADING_TOOL		1	0.000	0.000	0.000	<input type="checkbox"/>
5	ROTARY_DRILL		1	0.000	0.000	0.000	<input type="checkbox"/>
6							
7							
8							
9							
10							
11							
12							
	CUTTER		1	0.000	0.000	0.000	<input type="checkbox"/>
	DRILL		1	0.000	0.000	0.000	<input type="checkbox"/>
	TAP		1	0.000	0.000	0.000	<input type="checkbox"/>
	STOP		1	0.000	0.000	0.000	<input type="checkbox"/>

Machine	Description
Place	<ul style="list-style-type: none"> Place number in magazine Loading point in the loading magazine
Type	Tool type Depending on the tool type (represented as a symbol) certain tool correction data is released, e.g. Δ radius/Δ Ø
Tool name	The tool is identified by name.
D	Cutting number
Δ Length X	Wear at length X: This is only true for rotary tools: Display of length X in diameter or in radius is dependent on the setting in EMConfig. The default display set is diameter.
Δ Length Z	Wear at length Z
Δ Radius / Δ Ø	Radius wear or Ø WEAR
D	Tool disable The tool is blocked for use if the control box is active. At the same time the red cross will be shown in the "Tool type" column.

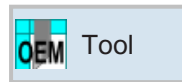
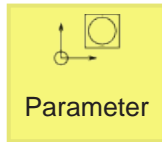

OEM tool

You can enter the adapter length X and the adapter length Z in the OEM tool data.

Tool data OEM					
Loc.	Type	Tool name	D	Adapter Lngth X	Adapter Lngth Z
1		ROUGHING_TOOL	1	0.000	0.000
2		FINISHING_TOOL	1	0.000	0.000
3		PLUNGE CUTTER	1	0.000	0.000
4		THREADING_TOOL	1	0.000	0.000
5		ROTARY_DRILL	1	0.000	0.000
6					
7					
8					
9					
10					
11					
12		CUTTER	1	0.000	0.000
		FACING TOOL	1	0.000	0.000
		DRILL	1	0.000	0.000
		TAP	1	0.000	0.000
		STOP	1	0.000	0.000

Sort ▶

Tool list
 Tool wear
 OEM Tool
 Maga-zine
 Work offset
 R User variables
 SD Setting data



Magazine



Tools with their magazine-related data will be shown in the magazine list.

Actions that relate to the magazine and magazine places can be carried out. Individual magazine places can be blocked for further use (Column "D").

Fixed places (column L) can only be selected in machines with random tool management.

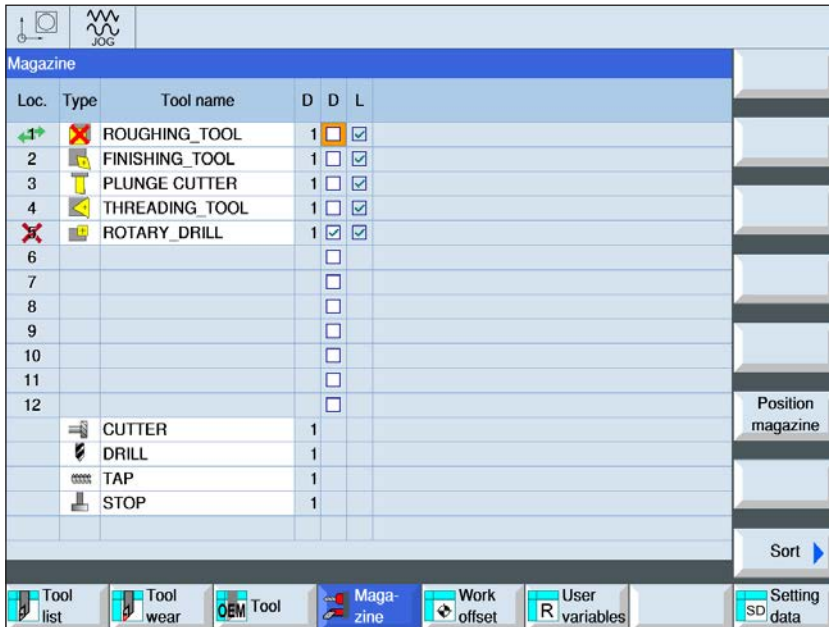
In general, all magazine spaces are simultaneously fixed places for all rotary machines.



Machine	Description
Place	Magazine/place number <ul style="list-style-type: none"> Magazine place numbers First the magazine number and then the place number in the magazine will be indicated. If only one magazine is available, only the place number will be shown.  <ul style="list-style-type: none"> Loading point in the loading magazine
Type	Tool type
Tool name	The tool is identified by the name.
D	Cutting number
D	Magazine place disable The magazine place is blocked when the control box is active. At the same time the red cross  will be shown in the "Magazine place" column.
L	Fixed location The tool is firmly assigned to this magazine place and cannot be processed.

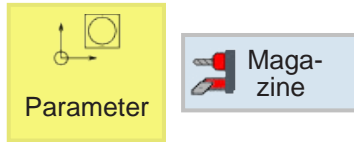

Position magazine

Magazine places can be positioned directly at the loading point.

- 1 Position cursor on the magazine place that can be swiveled directly on to the loading point.
- 2 Press softkey. The magazine place will be swiveled on to the loading point.
- 3 The green double arrow (1) on the magazine place shows that this magazine place is currently on this tool change point (loading position).

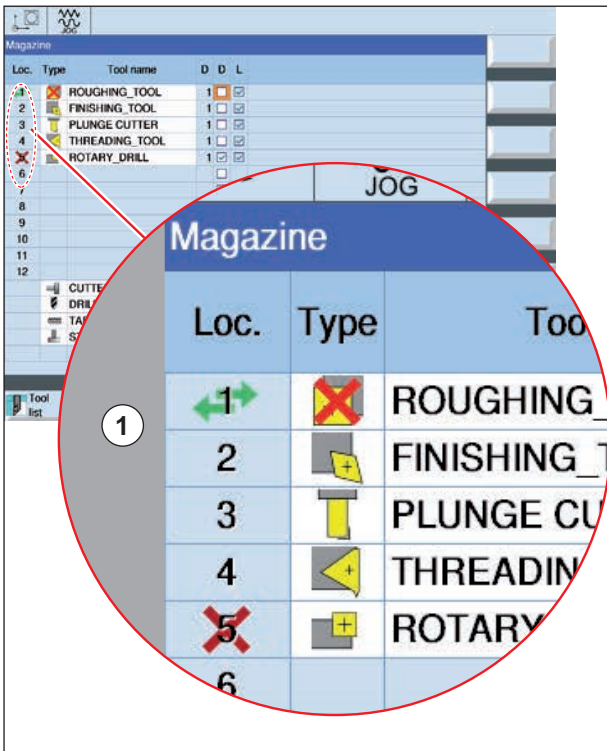

Magazine place is currently on the tool change point

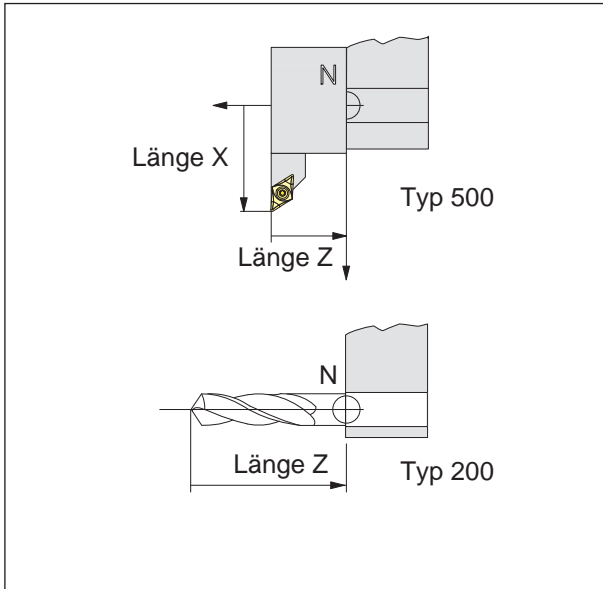

Direction of the length correction for tool types

Tool length correction

The tool length correction moves the tool zero point from the tool housing reference point N to the tool tip.

This is how all position details are related to the tool tip.

The tool housing reference point N in most machines is on the front face of the tool changer disk or the tool holder.

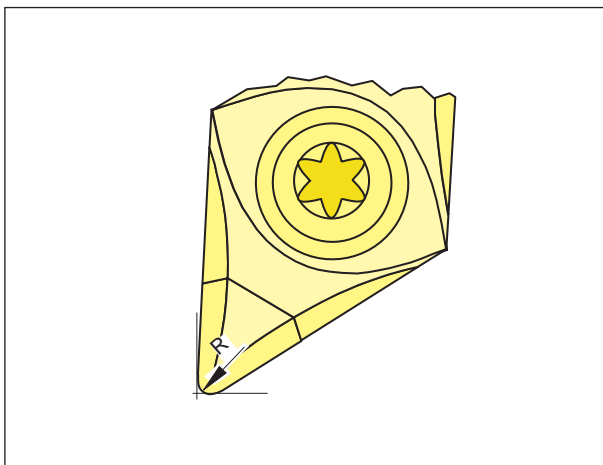

Cutting radius R

Cutting radius

The cutting radius data is needed only if a cutting radius compensation (G41, G42) is selected for the relevant tool.

Tool correction

Tool call-up for ISO programming:

1. Tool change:

The T command makes a direct tool change:

Syntax:

T = "Tool name"

T=1 ... number in magazine place

T1 ... tool

T0 deselects the tool.

2. Tool correction numbers D:

Each tool name can be assigned up to 9 tool correction numbers D.

The SINUMERIK Operate control system describes the correction data D as a cut.

A tool can have more than one correction number (e.g. a groover tool is measured on the right and left corners).

Depending on use, then the program calls up, say,

T = "GROOVER1" D1 or

T = "GROOVER1" D2.

The command D.. calls up the tool correction values D. The tools themselves are called up by name.

The data for the tool correction (tool, tool radius, etc.) will be read from the tool correction storage.

If no D is programmed, D1 is used automatically. D0 deselects tool correction.

The positions programmed below relate to the tool housing reference point N and not to the tool tip.

Tool call-up for shop programming: see cycle description "straight or circular machining" in chapter D.

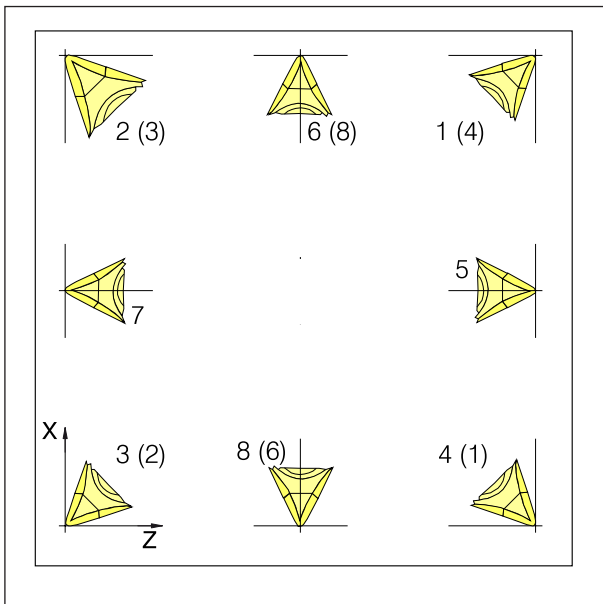

Cutting position of rotary tools

Cutting position of rotary tools

Consider the tool as if it is clamped to the machine to determine the type.

For machines, in which the tool is under (in front of) the rotary center (e.g. Concept Turn 55), the values in brackets must be used, owing to the reversal of the +X direction.

Rotary tools

- 500 Rough steel
- 510 Smooth steel
- 520 Groover steel
- 540 Thread steel
- 550 Mushroom
- 560 Rotary drill
- 580 3D turn measuring key
- 730 Stop

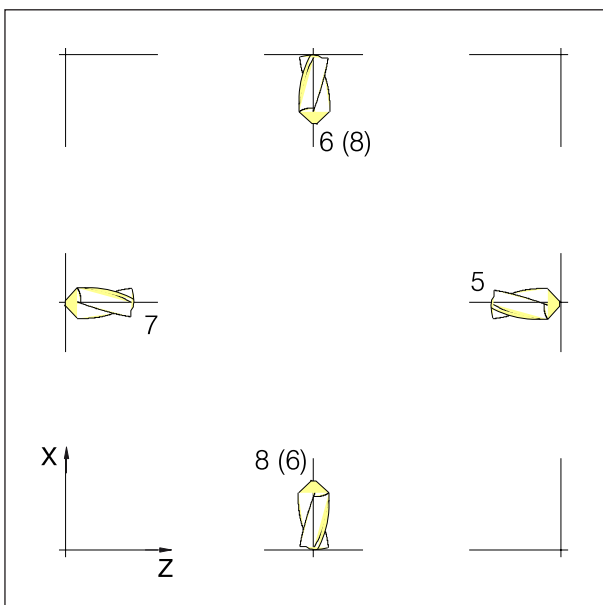

Cutting position of drilling and milling tools

Cutting position of milling and drilling tools

Tool types:

Drilling tools

- 200 Spiral drill
- 240 Tap control thread

Milling tools

- 110 Spherical head cylinder
- 120 Milling cutter
- 140 Surface milling cutter
- 145 Thread milling cutter
- 150 Disk milling cutter

Instructions:
Measuring tools is only possible with an active tool.

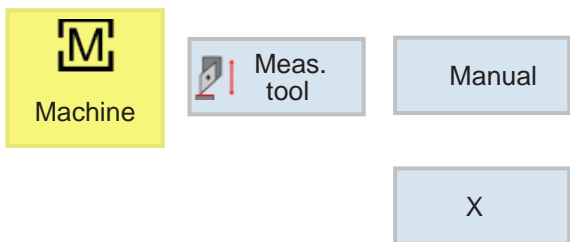
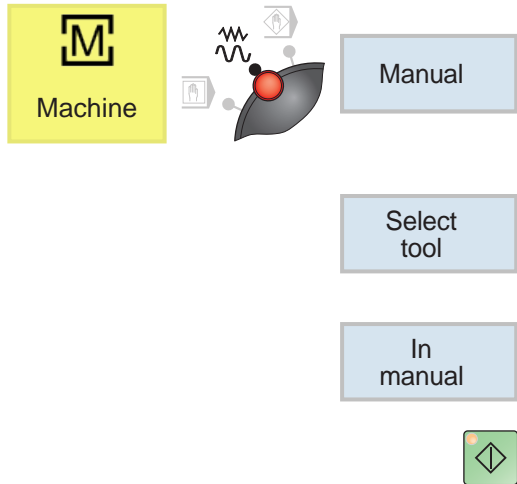

Measuring tool manually

Precondition:

The tool to be measured has already been created in the tool list and is physically located at the magazine place. The created tool should now be measured.

- 1 Switch to the TSM window.

For measuring tools, the workpiece for machining will be used.

- 2 Using the softkey, select the already created tool from the tool list.

- 3 Press softkey.

- 4 Press NC-Start button.

- 5 Surface turning

The workpiece should be clamped such that there is sufficient space to reach the front and lateral surfaces with any tool.

The workpiece will first be surface-turned manually,

for this, the speed will be set to 1000 rpm.

The front and side surfaces will be surface and longitudinally turned so as to create the prerequisite for as exact a measurement as possible.

- 6 Measuring tool manually.

- 7 Pressing softkeys

- 8 Press softkey

Enter the value measured at X0 with the slide gauge.

The measured value is the diameter of the workpiece.



Set up the tool changer in a way such that the length from the front to the changer can be measured.

Z

9 Press softkey

Instructions:

Note that no lengths should be entered for Z0 before measurement. The length entries must be set to 0 first.



Read the value for the length Z from the slide gauge.



10 Scratch the tool from the front in Jog mode.

Set length

11 Press softkey

For measuring tools, the workpiece for machining will be used.

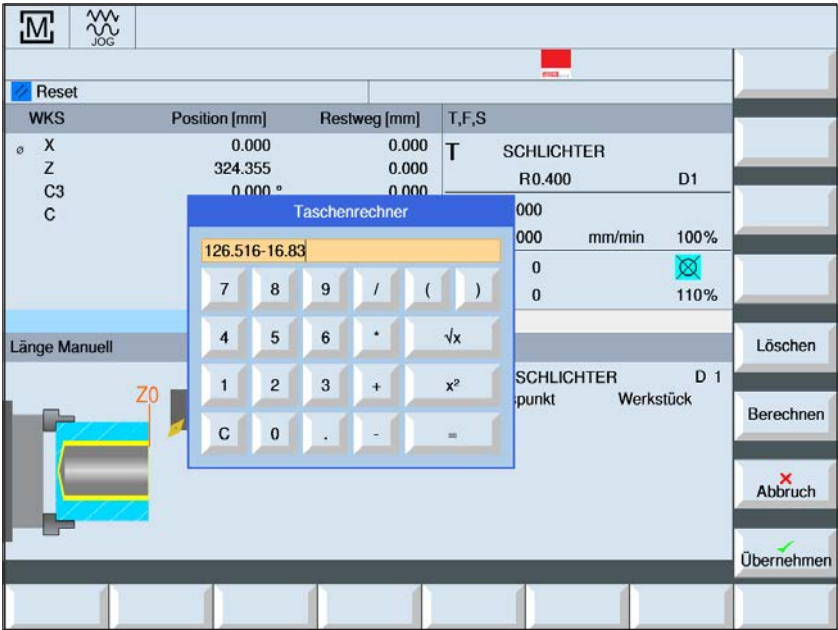

Setting
Reference point: Workpiece

The calculation produces for Z0:
 $126.516 - 16.83 = 109.686$

126.516 is the position of the Z-axis at the time of the measurement

For measuring tools, the workpiece for machining will be used.

X

Set length

12 Scratch the tool on the side, press the softkey X to switch to X and press the Set length softkey

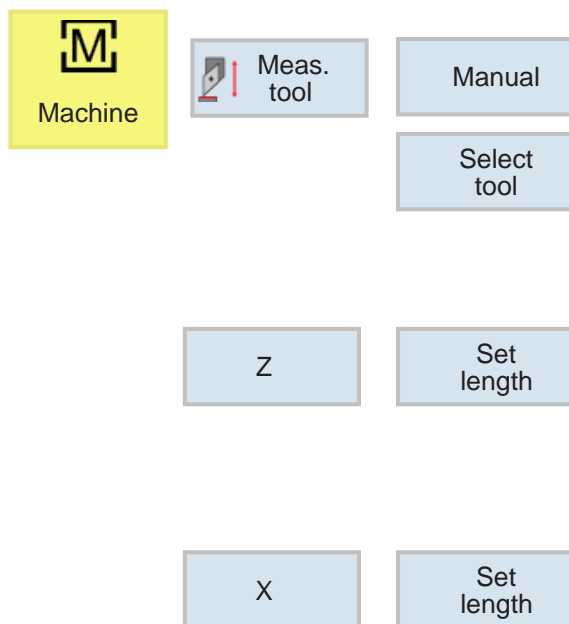

13 The following steps must be repeated for all tools:

Move the tool away

Place a new tool (if the machine is still unfitted)

- Bring the next tool into the working position
- Select tool
- Move the tool to the front
- Pressing softkeys
- Move the tool to the side
- Pressing softkeys

Measure the tool with the optical default setting device at the machine

Instructions:

While the reference tool is in use, no tool correction data and zero point offsets should be active.

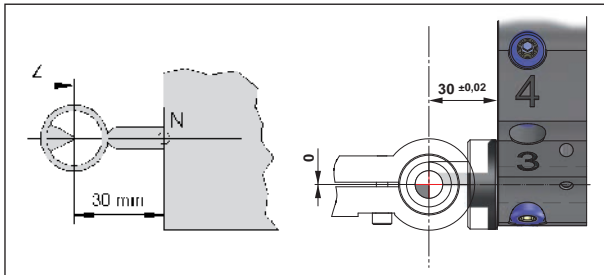

Reference tool measurement Concept Turn 55/60

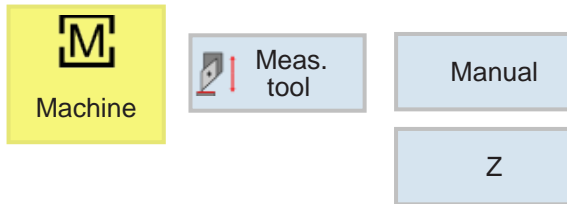

- 1 This method is more accurate, because contacts are avoided and the tool is shown magnified in the optics

The length must be observed for the reference tool. The exact length must be known.

The reference tool is used only to determine the position of the optic cross-hairs in the MKS

2 Procedure:

- Mount the reference tool and tilt it into the working position
- Move the reference tool behind the cross hairs
- Pressing softkeys

Setting

Reference point: Workpiece

Calculate Z0:
114.699 - Reference tool length

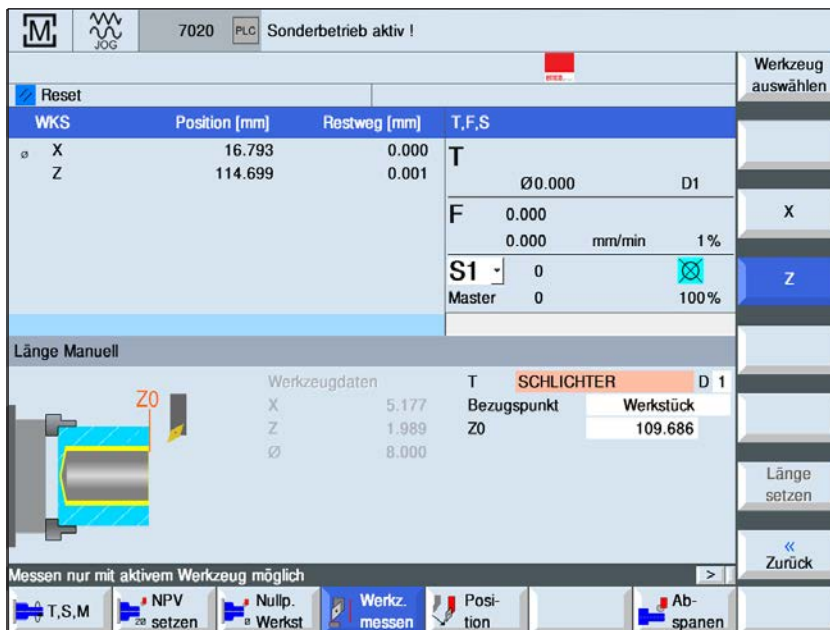

Z

- Press softkey

Enter X0 value from the position display under X0:
16.793

- the reference tool can now be removed from the machine.

3 Measure tool:

- tilt the tool to be measured into the working position
- Move the tool behind the cross hairs

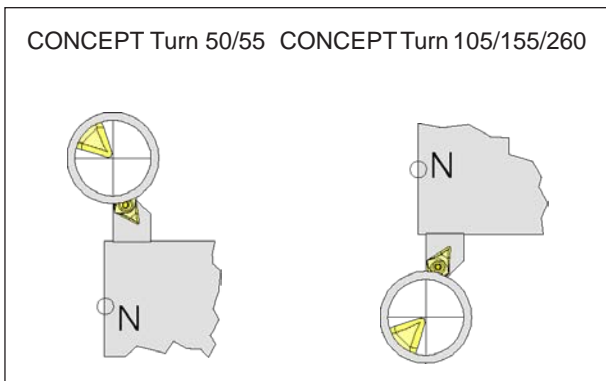

Move the tool behind the cross hairs

4 Select tool and set length

Select tool

- Select tool
select the current tool with the cursor

In manual

- Press softkey

X

- Press softkey

Set length

Z

- Press softkey

Set length

Now the tool is to measure

Tilt in the tool step until Set length is repeated for every tool (points 3 to 4)

G: Program sequence

Instructions:

During the program sequence the tool data for the tools used may not be changed.



Preconditions

Set zero points

The zero points used must be measured and entered.

Tools

The tools used must be measured and entered. The tools must be in the corresponding positions (t) in the tool changer.

Reference point

The reference point must be approached in all axes.

Machine

The machine must be ready for operation. The workpiece must be securely clamped. Loose parts (spanners, etc.) must be removed from the work area to avoid collisions. The machine doors must be closed at the start of the program.

Alarms

There must be no alarms pending.



NC start

This button switches from "JOG" mode to "AUTO" mode and starts the NC program run.

For the NC program run to be started, a Sinumerik Operate program must be open. The file name of the currently open Sinumerik Operate program is shown in the center of the simulation window.



NC reset

This button switches from "AUTO" mode to "JOG" mode, cancels the NC program run and resets to the start state.



NC Stop

This button stops the NC program run. The simulation can be continued with this "NC-Start" button.

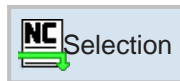

Program start, program stop

- Select a program for execution.
- Press the "NC start" button.
- Stop program with "NC stop", continue with "NC start".
- Cancel program with "NC reset".



Repositioning



If a program interruption occurs in automatic mode, e.g. after a tool break, then the tool can be moved away from the contour in manual mode.

To avoid later collisions the axes must be moved to a safe position.

The coordinates of the interruption position will be saved.

The travel difference between the axes that has been brought about in manual mode is shown in the current values window. This travel difference is called "Repos shift".

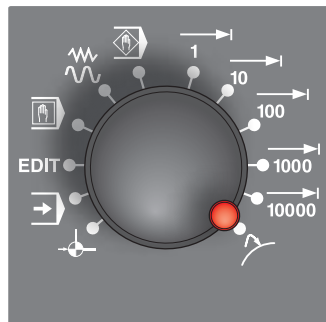

Continue program execution:

- Select REPOS mode. Thus the tool can again be brought to the contour of the workpiece.

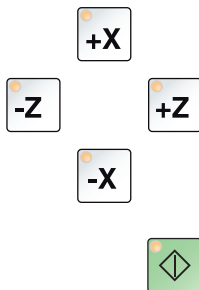

- Select each axis to be moved one after the other and move to the cancellation position.

- Continue the processing in automatic mode again with "NC start".

H: Alarms and Messages

Machine Alarms 6000 - 7999

These alarms will be triggered by the machines. There are different alarms for the different machines. The alarms 6000 - 6999 normally must be confirmed with RESET. The alarms 7000 - 7999 are messages which normally will disappear when the releasing situation is finished.

PC MILL 50 / 55 / 100 / 105 / 125 / 155 Concept MILL 55 / 105 / 155

6000: EMERGENCY OFF

The EMERGENCY OFF key was pressed. Remove the endangering situation and restart machine and software.

6001: PLC-CYCLE TIME EXCEEDING

Contact EMCO Service.

6002: PLC - NO PROGRAM CHARGED

Contact EMCO Service.

6003: PLC - NO DATA UNIT

Contact EMCO Service.

6004: PLC - RAM MEMORY FAILURE

Contact EMCO Service.

6005: OVERHEAT BRAKEMODUL

Main drive was braked too often, large changes of speed within a short time. E4.2 active

6006: OVERLOAD BRAKE RESISTOR

see 6005

6007: SAFETY CIRCUIT FAULT

Axis and main drive contactor with machine switched off not disabled. Contactor got stuck or contact error. E4.7 was not active during switch-on.

6008:MISSING CAN SUBSCRIBER

Check fuses or EMCO customer service.
Contact EMCO Service.

6009: SAFETY CIRCUIT FAULT

A running CNC program will be interrupted, the auxiliary drives will be stopped, the reference position will be lost.

6010: DRIVE X-AXIS NOT READY

The step motor board is defective or too hot, a fuse or cabling is defective.

A running program will be stopped, the auxiliary drives will be switched off, the reference position will be lost.

Check fuses or contact EMCO service.

6011: DRIVE Y-AXIS NOT READY

see alarm 6010.

6012: DRIVE Z-AXIS NOT READY

see alarm 6010.

6013: MAIN DRIVE NOT READY

Main drive power supply defective, main drive too hot, fuse defective.

A running program will be stopped, the auxiliary drives will be switched off.

Check fuses or contact EMCO Service.

6014: NO MAIN SPINDLE SPEED

This will be released, when the spindle speed is lower than 20 rpm because of overload.

Alter cutting data (feed, infeed, spindle speed).

The CNC program will be aborted, the auxiliary drives will be stopped.

6019: VICE TIME EXCEED

The electric vice has not reached a stop position within 30 seconds.

The control or the clamping device board are defective, the vice is stuck. Adjust the proximity switches of the stop position.

6020: VICE FAILURE

When the electric vice is closed, the signal "clamping device clamped" of the clamping device board has failed.

The control, the clamping device board or the wiring are defective.

K 2017-07

6022: CLAMPING DEVICE BOARD DEFECTIVE

The signal "clamping device clamped" is constantly released, although no command has been given.

Replace the board.

6024: MACHINE DOOR OPEN

The door was opened while a machine movement. The program will be aborted.

6027: DOOR LIMIT SWITCH DEFECTIVE

The limit switch of the automatic door is displaced, defective, wrong cabled.

Contact EMCO service.

6028: DOOR TIMEOUT

The automatic door sticks, the pressured air supply is insufficient, the limit switch is displaced. Check door, pressured air supply, limit switch or contact EMCO service.

6030: NO PART CLAMPED

No workpiece inserted, vice cheek displaced, control cam displaced, hardware defective.

Adjust or contact EMCO service.

6040: TOOL TURRET INDEX FAILURE

After WZW procedure drum pressed down by Z-axis. Spindle position wrong or mechanical defect. E4.3=0 in lower state

6041: TOOL CHANGE TIMEOUT

Tool drum sticks (collision?), main drive not ready, fuse defective, hardware defective.

A running CNC program will be stopped.

Check for collisions, check fuses or contact EMCO service.

6043-6046: TOOL DISK POSITION FAULT

Position error of main drive, error of position supervising (inductive proximity switch defective or disadjusted, drum allowance), fuse defective, hardware defective.

The Z axis could have been slipped out of the toothing while the machine was switched off.

A running CNC program will be stopped.

Contact EMCO service.

6047: TOOL DISK UNLOCKED

Tool drum turned out of locked position, inductive proximity switch defective or disadjusted, fuse defective, hardware defective.

A running CNC program will be interrupted.

Contact EMCO service.

When the tool drum is turned out of locked position (no defect), act as following:

Turn the drum into locking position manually

Change into MANUAL (JOG) mode.

Turn the key switch. Traverse the Z slide upwards, until the alarm disappears.

6048: DIVIDING TIME EXCEEDED

Dividing head sticks, insufficient pressured air supply, hardware defective.

Check for collision, check pressured air supply or contact EMCO service.

6049: INTERLOCKING TIME EXCEEDED

see alarm 6048

6050: M25 AT RUNNING MAIN SPINDLE

Cause: Programming mistake in NC program.

A running program will be aborted.

The auxilliary drives will be switched off.

Remedy: Correct NC program

6064: DOOR AUTOMATIC NOT READY

Cause: pressure failure automatic door
automatic door sticks mechanically
limit switch for open end position defective
security print circuits defect
cabling defective
fuses defective

A running program will be aborted.

The auxilliary drives will be switched off.

Remedy: service automatic door

6069: CLAMPING FOR TANI NOT OPEN

When opening the clamping pressure switch does not fall within 400ms. Pressure switch defective or mechanical problem. E22.3

6070: PRESSURE SWITCH FOR TANI MISSING

When closing the clamping pressure switch does not respond. No compressed air or mechanical problem. E22.3

6071: DIVIDING DEVICE NOT READY

Servo Ready Signal from frequency converter missing. Excess temperature drive TANI or frequency converter not ready for operation.

6072: VICE NOT READY

Attempt to start the spindle with an open vice or without clamped workpiece.

Vice sticks mechanically, insufficient compressed air supply, compressed air switch defective, fuse defective, hardware defective.

Check the fuses or contact EMCO service.

6073: DIVIDING DEVICE NOT READY

Cause: locking switch defective
cabling defective
fuses defective

A running program will be aborted.

The auxiliary drives will be switched off.

Remedy: service automatic dividing device
lock the dividing device

6074: DIVIDING TIME EXCEEDED

Cause: dividing device sticks mechanically
locking switch defective
cabling defective
fuses defective
insufficient compressed-air supply.

A running program will be aborted.

The auxiliary drives will be switched off.

Remedy: Check for collision, check the compressed-air supply or contact the EMCO service.

6075: M27 AT RUNNING MAIN SPINDLE

Cause: Programming mistake in NC program.

A running program will be aborted.

The auxiliary drives will be switched off.

Remedy: Correct NC program

6110: 5TH AXIS NOT CONNECTED

Cause: 4th/5th axis was selected in EMConfig, but not connected electrically.

Remedy: Connect 4th/5th axis or deselect in EM-Config.

6111: 5TH AXIS CONNECTED

Cause: 4th/5th axis was deselected in EMConfig, but is electrically connected.

Remedy: Remove 4th/5th axis from machine or select in EMConfig.

6112: MOTOR PROTECTION RELEASED

Cause: A motor protection switch has triggered. A possibly active NC program is stopped immediately.

Remedy: Check the device connected to the motor protection switch and switch on again. If recurring, contact EMCO service department.

7000: INVALID TOOL NUMBER PROGRAMMED

The tool position was programmed larger than 10. The CNC program will be stopped.

Interrupt program with RESET and correct the program.

7001: NO M6 PROGRAMMED

For an automatic tool change you also have to program a M6 after the T word.

7007: FEED STOP!

The axes have been stopped by the robotics interface (robotics entry FEEDHOLD).

7016: SWITCH ON AUXILIARY DRIVES

The auxiliary drives are off. Press the AUX ON key for at least 0.5 sec. (to avoid accidentally switching on) to switch on the auxiliary drives.

7017: REFERENCE MACHINE

Approach the reference point.

When the reference point is not active, manual movements are possible only with key switch at position "setting operation".

7018: TURN KEY SWITCH

With NC-Start the key switch was in position "setting operation".

NC-Start is locked.

Turn the key switch in the position "automatic" to run a program.

7020: SPECIAL OPERATION MODE ACTIVE

Special operation mode: The machine door is opened, the auxiliary drives are switched on, the key switch is in position "setting operation" and the consent key is pressed.

Manual traversing the axes is possible with open door. Swivelling the tool turret is not possible with open door. Running a CNC program is possible only with standing spindle (DRYRUN) and SINGLE block operation.

For safety: If the consent key is pressed for more than 40 sec. the function of this key is interrupted, the consent key must be released and pressed again.

7021: INITIALIZE TOOL TURRET

The tool turret operating was interrupted.

No traversing operation is possible.

Press tool turret key in JOG operation. Message occurs after alarm 6040.

7022: INITIALIZE TOOL TURRET!

see 7021

7023: WAITING TIME MAIN DRIVE!

The LENZE frequency converter has to be separated from the mains supply for at least 20 seconds before you are allowed to switch it on again. This message will appear when the door is quickly opened/ closed (under 20 seconds).

7038: LUBRICATION SYSTEM FAULT

The pressure switch is defective or gagged.

NC-Start is locked. This can be reset only by switching off and on the machine.

Contact EMCO service.

7039: LUBRICATION SYSTEM FAULT

Not enough lubricant, the pressure switch is defective.

NC-Start is locked.

Check the lubricant and lubricate manually or contact EMCO service.

7040: MACHINE DOOR OPEN

The main drive can not be switched on and NC-Start can not be activated (except special operation mode)

Close the machine to run a program.

7042: INITIALIZE MACHINE DOOR

Every movement and NC-Start are locked.

Open and close the machine door to initialize the safety circuits.

7043: PIECE COUNT REACHED

A predetermined number of program runs was reached. NC-Start is locked. Reset the counter to continue.

7050: NO PART CLAMPED

After switching on or after an the vice is neither at the open position nor at the closed position.

NC-Start is locked.

Traverse the vice manually on a valid end position.

7051: DIVIDING HEAD NOT LOCKED!

Either the dividing head is in an undefined position after the machine has been switched on, or the locking signal after a dividing process is missing.

Initiate the dividing process, check, respectively adjust the proximity switch for locking.

7054: VICE OPEN

Cause: the workpiece is not clamped

When switching on the main spindle with M3/M4 alarm 6072 (vice not ready) will be released.

Remedy: Clamp

7055: OPEN TOOL CLAMPING SYSTEM

A tool is clamped in the main spindle and the control does not recognize the corresponding T number.

Eject the tool from the main spindle when the door is open by means of the PC keys "Strg" and " 1 ".

7056: SETTING DATA INCORRECT

An invalid tool number is stored in the setting data.

Delete the setting data in the machine directory xxxxx.pls.

7057: TOOLHOLDER OCCUPIED

The clamped tool cannot be positioned in the tool turret since the position is occupied.

Eject the tool from the main spindle when the door is open by means of the PC keys "Strg" and " 1 ".

7058: RETRACTING THE AXES

The position of the tool turret arm cannot be clearly defined during the tool change.

Open the machine door, push the tool turret magazine backwards to the stop. Move the milling head in the JOG mode upwards to the Z reference switch and then traverse the reference point.

7087: MOTOR PROTECTION HYDRAULIC CLAMPING RELEASED!

Hydraulic motor is defective, stiff, circuit breaker is set incorrectly.

Replace motor or check circuit breaker and replace if necessary.

7090: ELECTRICAL CABINET OVERRIDE SWITCH ACTIVE

The cabinet door can only be opened when the key switch is switched on without raising an alarm.

Switch off key switch.

7107: MOTOR PROTECTION RELEASED

A motor protection switch has triggered. A possibly running NC program will be completed. A new NC start will be prevented.

Check the device connected to the motor protection switch and switch on again. If recurring, contact EMCO service department.

7270: OFFSET COMPENSATION ACTIVE !

Only with PC-MILL 105

Offset compensation activated by the following operation sequence.

- Reference point not active
- Machine in reference mode
- Key switch in manual operation
- Press STRG (or CTRL) and simultaneously 4

This must be carried out if prior to the tool change procedure spindle positioning is not completed (tolerance window too large)

7271: COMPENSATION FINISHED, DATA SAVED !

see 7270

PC TURN 50 / 55 / 105 / 120 / 125 / 155
Concept TURN 55 / 60 / 105 / 155 /
250 / 260 / 460
Concept MILL 250
EMCOMAT E160
EMCOMAT E200
EMCOMILL C40
EMCOMAT FB-450 / FB-600

6000: EMERGENCY OFF

The EMERGENCY OFF key was pressed.
 The reference position will be lost, the auxiliary drives will be switched off.
 Remove the endangering situation and restart machine and software.

6001: PLC-CYCLE TIME EXCEEDING

The auxiliary drives will be switched off.
 Contact EMCO Service.

6002: PLC - NO PROGRAM CHARGED

The auxiliary drives will be switched off.
 Contact EMCO Service.

6003: PLC - NO DATA UNIT

The auxiliary drives will be switched off.
 Contact EMCO Service.

6004: PLC - RAM MEMORY FAILURE

The auxiliary drives will be switched off.
 Contact EMCO Service.

6005: K2 OR K3 NOT DE-ENERGIZED

Turn machine on/off. Defective security board.

6006 EMERGENCY-OFF RELAY K1 NOT DE-ENERGIZED

Turn machine on/off. Defective security board.

6007 SAFETY CIRCUIT FAULT**6008: MISSING CAN SUBSCRIBER**

The PLC-CAN board is not identified by the control.
 Check the interface cable and the power supply of the CAN board.

6009: SAFETY CIRCUIT FAULT**6010: DRIVE X-AXIS NOT READY**

The step motor board is defective or too hot, a fuse is defective, over- or undervoltage from mains.

A running program will be stopped, the auxiliary drives will be switched off, the reference position will be lost.

Check fuses or contact EMCO service.

6011: DRIVE Z-AXIS NOT READY

see 6010.

6012: DRIVE Z-AXIS NOT READY

see 6010.

6013: MAIN DRIVE NOT READY

Main drive power supply defective or main drive too hot, fuse defective, over- or undervoltage from mains.

A running program will be stopped, the auxiliary drives will be switched off.

Check fuses or contact EMCO Service.

6014: NO MAIN SPINDLE SPEED

This alarm will be released, when the spindle speed is lower than 20 rpm because of overload. Alter cutting data (feed, infeed, spindle speed).

The CNC program will be aborted, the auxiliary drives will be switched off.

6015: NO DRIVEN TOOL SPINDLE SPEED

see 6014.

6016: AUTOMATIC TOOL TURRET SIGNAL COUPLED MISSING**6017: AUTOMATIC TOOL TURRET SIGNAL UNCOUPLED MISSING**

In the tool turret that can be coupled, the position of the coupling and uncoupling magnet is monitored by means of two proximity switches. It has to be made sure that the coupling is in the rear stop position so that the tool turret can get to the next tool position. Equally, during operation with driven tools the coupling has to be safe in the front stop position.

Check and adjust the cables, the magnet and the stop position proximity switches.

6018: AS SIGNALS, K4 OR K5 NOT DE-ENERGIZED

Turn machine on/off. Defective security board.

6019: POWER SUPPLY MODULE NOT READY

Turn machine on/off. Power supply module, defective axis controller 6020 AWZ drive failure turn machine on/off, defective axis controller.

6020: DRIVEN TOOL DRIVE MALFUNCTION

The driven tool power supply defective or the driven tool drive is too hot, fuse defective, mains overvoltage or undervoltage. A running CNC program will be aborted, the auxiliary drives will be stopped. Check the fuses or contact EMCO service.

6021: COLLET TIME OUT

During closing of the clamping device the pressure switch has not reacted within one second.

6022: CLAMPING DEVICE BOARD DEFECTIVE

The signal "clamping device clamped" is constantly released, even though no command has been given. Replace the board.

6023: COLLET PRESSURE MONITORING

The pressure switch turns off when the clamping device is closed (compressed air failure for more than 500ms).

6024: MACHINE DOOR OPEN

The door was opened while a machine movement. The program will be aborted.

6025: GEARBOX COVER NOT CLOSED

The gearbox cover was opened while a machine movement. A running CNC program will be aborted. Close the cover to continue.

6026: MOTOR PROTECTION COOLANT PUMP RELEASED**6027: DOOR LIMIT SWITCH DEFECTIVE**

The limit switch of the automatic door is displaced, defective, wrong cabled. Contact EMCO service.

6028: DOOR TIMEOUT

The automatic door sticks, the pressured air supply is insufficient, the limit switch is displaced. Check door, pressured air supply, limit switch or contact EMCO service.

6029: TAILSTOCK QUILL TIME EXCEED

The tailstock quill does not reach a final position within 10 seconds.

Adjust the control and the stop position proximity switches, or the tailstock quill is stuck.

6030: NO PART CLAMPED

No workpiece inserted, vice cheek displaced, control cam displaced, hardware defective. Adjust or contact EMCO service.

6031: QUILL FAILURE**6032: TOOL CHANGE TIMEOUT**

see alarm 6041.

6033: TOOL TURRET SYNC ERROR

Hardware defective. Contact EMCO service.

6037: CHUCK TIMEOUT

The pressure switch does not react within one second when the clamping device is closed.

6039: CHUCK PRESSURE FAILURE

The pressure switch turns off when the clamping device is closed (compressed air failure for more than 500ms).

6040: TOOL TURRET INDEX FAILURE

The tool turret is in no locked position, tool turret sensor board defective, cabling defective, fuse defective.

A running CNC program will be stopped.

Swivel the tool turret with the tool turret key, check fuses or contact EMCO service.

6041: TOOL CHANGE TIMEOUT

Tool drum sticks (collision?), fuse defective, hardware defective.

A running CNC program will be stopped.

Check for collisions, check fuses or contact EMCO service.

6042: TOOL TURRET OVERHEAT

Tool turret motor too hot.

With the tool turret a max. of 14 swivel procedures a minute may be carried out.

6043: TOOL CHANGE TIMEOUT

Tool drum sticks (collision?), fuse defective, hardware defective.

A running CNC program will be stopped.

Check for collisions, check fuses or contact EMCO service.

6044: BRAKING RESISTANCE - MAIN DRIVE OVERLOADED

Reduce number of speed changes in the program.

6045: TOOL TURRET SYNC MISSING

Hardware defective.
Contact EMCO service.

6046: TOOL TURRET ENCODER FAULT

Fuse defective, hardware defective.
Check fuses or contact EMCO service.

6048: CHUCK NOT READY

Attempt to start the spindle with open chuck or without clamped workpiece.
Chuck sticks mechanically, insufficient pressured air supply, fuse defective, hardware defective.
Check fuses or contact EMCO service.

6049: COLLET NOT READY

see 6048

6050: M25 DURING SPINDLE ROTATION

With M25 the main spindle must stand still (consider run-out time, evtl. program a dwell)

6055: NO PART CLAMPED

This alarm occurs when with rotating spindle the clamping device or the tailstock reach the end position. The workpiece has been pushed out of the chuck or has been pushed into the chuck by the tailstock. Check clamping device settings, clamping forces, alter cutting data.

6056: QUILL NOT READY

Attempt to start the spindle or to move an axis or to swivel the tool turret with undefined tailstock position.
Tailstock is locked mechanically (collision), insufficient pressured air supply, fuse defective, magnetic switch defective.
Check for collisions, check fuses or contact EMCO service.

6057: M20/M21 DURING SPINDLE ROTATION

With M20/M21 the main spindle must stand still (consider run-out time, evtl. program a dwell)

6058: M25/M26 DURING QUILL FORWARD

To actuate the clamping device in an NC program with M25 or M26 the tailstock must be in back end position.

6059: C-AXIS SWING IN TIMEOUT

C-axis does not swivel in within 4 seconds.
Reason: not sufficient air pressure, and/or mechanics stuck.

6060: C-AXIS INDEX FAILURE

When swivelling in the C-axis the limit switch does not respond.
Check pneumatics, mechanics and limit switch.

6064: AUTOMATIC DOOR NOT READY

Door sticks mechanically (collision), insufficient pressured air supply, limit switch defective, fuse defective.
Check for collisions, check fuses or contact EMCO service.

6065: LOADER MAGAZINE FAILURE

Loader not ready.
Check if the loader is switched on, correctly connected and ready for operation and/or disable loader (WinConfig).

6066: CLAMPING DEVICE FAILURE

No compressed air at the clamping device
Check pneumatics and position of the clamping device proximity detectors.

6067: NO COMPRESSED AIR

Turn the compressed air on, check the setting of the pressure switch.

6068: MAINDRIVE OVERTEMPERATURE**6070: LIMIT SWITCH TAILSTOCK SLEEVE ACTIVE**

Cause: The axis arrived in the tailstock sleeve.
Remedy: Drive the travel off the tailstock sleeve.

6071: LIMIT SWITCH X AXIS ACTIVE

Cause: The axis arrived to the end switch.
Remedy: Drive the axis off the end switch again.

6072: LIMIT SWITCH Z AXIS ACTIVE

see 6071

6073: CHUCK GUARD OPEN

Cause: The chuck guard is open.
Remedy: Close the chuck guard.

6074: NO FEEDBACK FROM USB-PLC

Turn machine on/off. Check cabling, defective USB board.

6075: AXIS LIMIT SWITCH TRIGGERED

see 6071

6076: DRIVE Y-AXIS NOT READY

see 6010

6077 VICE NOT READY

Cause: Loss of pressure in clamping system.
Remedy: Check pressurised air and air ducts.

6078 MOTOR PROTECTION TOOL MAGAZINE RELEASED

Cause: Swing intervals are too short.
Remedy: Raise swing intervals.

6079 MOTOR PROTECTION TOOL CHANGER RELEASED

see 6068

6080 PRESSURE SWITCH FOR TANI MISSING

Cause: The pressure switch fails to active when the clamping closes. No pressurised air or mechanical problem.
Remedy: Check pressurised air.

6081 CLAMPING FOR TANI NOT OPEN

see 6080

6082 FAULT AS/SIGNAL

Cause: Active Safety-Signal X/Y-controller is faulty.
Remedy: Delete alarm using the RESET key and/or switch the machine on/off. If this error reoccurs, contact EMCO.

6083 FAULT AS/SIGNAL

Cause: Active Safety-Signal main spindle/Z-controller is faulty.
Remedy: Delete alarm using the RESET key and/or switch the machine on/off. If this error reoccurs, contact EMCO.

6084 FAULT AS/SIGNAL UE-MODUL

Cause: Active Safety-Signal Uncontrolled power supply module is faulty.
Remedy: Delete alarm using the RESET key and/or switch the machine on/off. If this error reoccurs, contact EMCO.

6085 N=0 RELAY NOT DE-ENERGIZED

Cause: Rotation zero relay did not drop.
Remedy: Delete alarm using the RESET key and/or switch the machine on/off. If this error reoccurs, contact EMCO (replace relay).

6086 DIFFERENT DOOR-SIGNALS FROM USBPLC AND ACC-PLC

Cause: ACC-PLC and USBSPS receive different door status reports.
Remedy: Delete alarm using the RESET key. If this error reoccurs, contact EMCO.

6087 DRIVE A-AXIS NOT READY

see 6010

6088 PROTECT SWITCH DOOR CONTROL UNIT RELEASED

Cause: Door drive overload.
Remedy: Cancel alarm with RESET button or switch machine on/off. If the problem occurs several times, contact EMCO (replace motor, drive).

6089 DRIVE B-AXIS NOT READY

see 6010

6090 CHIP CONVEYOR CONTACTOR NOT DE-ENERGIZED

Cause: Chip conveyor guard not down.
Remedy: Cancel alarm with RESET button or switch machine on/off. If the problem occurs several times, contact EMCO (replace guard).

6091 AUTOMATIC DOOR CONTACTOR NOT DE-ENERGIZED

Cause: Automatic door guard not down.
Remedy: Cancel alarm with RESET button or switch machine on/off. If the problem occurs several times, contact EMCO (replace guard).

6092 EMERGENCY-OFF EXTERNAL**6093 FAULT AS/SIGNAL A-AXIS**

Cause: Active Safety-Signal A control element faulty.
Remedy: Cancel alarm with RESET button or switch machine on/off. If the problem occurs several times, contact EMCO.

6095 OVERHEATING IN THE SWITCHGEAR CABINET

Cause: Temperature monitoring responded.
Remedy: Check switchgear cabinet filter and fan, raise triggering temperature, switch machine on and off.

6096 SWITCHGEAR CABINET DOOR OPEN

Cause: Switchgear cabinet door opened without key switch release.
Remedy: Close switchgear cabinet door, switch machine off and on.

6097 EMERGENCY-OFF TEST REQUIRED

Cause: Functional test of Emergency off.
 Remedy: Press EMERGENCY-OFF button on the control panel and unlock again. Press Rest-button to acknowledge the emergency stop state.

6098 FLOAT SWITCH HYDRAULIC MISSING

Effect: Auxiliary units are switched off.
 Meaning: The hydraulic float switch has released.
 Remedy: Refill hydraulic oil.

6099 PROX. SWITCH SPINDLE-BRAKE 1 MISSING

Effect: Feed stop, Read in lock
 Meaning: M10 Spindle brake on → Inductive proximity switch stays 0.
 M11 Spindle brake off → Inductive proximity switch stays 1.
 Remedy: Check inductive proximity switch, check magnetiv valve spindle brake.

6100 LOW PRESSURE QUILL

Effect: Auxiliary units are switched off.
 Meaning: At the moment of a spindle start command the tailstock pressure was not built up or the pressure dropped while spindle run.
 Remedy: Check clamping device pressure and pressure switch.
 Check program.

6101 QUILL -B3 OR -B4 MISSING

Effect: Feed stop, Read in lock
 Meaning: The magnetic valve for the movement of the quill was activated, but the switches -B3 and -B4 does not alter its status.
 Remedy: Check switches, magnetic valves.

6102 QUILL POSITION ALARM (PART MOVED?)

Effect: Feed stop, Read in lock
 Meaning: The tailstock target position was overtravelled in AUTOMATIC mode.
 Remedy: Check tailstock target position, check technology (clamping device pressure higher, tailstock pressure lower)

6103 QUILL NO BACKPOSITION

Effect: Feed stop, Read in lock
 Meaning: The magnetic valve for the tailstock was activated, but the switch for "tailstock back" stays 0.
 Remedy: Check magnetic valve, check switch.

6104 LOW PRESSURE CLAMPING EQUIPMENT 1

Effect: Auxiliary units are switched off.
 Meaning: At the moment of a spindle start command the clamping pressure was not built up or the clamping pressure dropped while spindle run.
 Remedy: Check clamping device pressure and pressure switch.
 Check program.

6105 CLAMPING EQUIPMENT 1 NOT OPEN

Effect: Feed stop, Read in lock
 Meaning: The analogous proximity switch for clamping device 1 was not actuated.
 Remedy: Adjust inductive proximity switch (see "Machine Description - chapter "C Programming and operation").

6106 CLAMPING EQUIPMENT 1 NOT CLOSED

Effect: Feed stop, Read in lock
 Meaning: The pressure switch for "clamping device closed" does not switch.
 Remedy: Check pressure switch

6107 LIMIT SWITCH CLAMPING EQUIPMENT 1

Effect: Auxiliary units are switched off.
 Remedy: Adjust clamping device (do not clamp in end position of the clamping system - see "Machine Description, chapter C Programming and Operation").

6108 PARTS CATCHER FORWARD MISSING

Effect: Feed stop, Read in lock
 Meaning: The magnetic valve for "collection tray forward/backward" was activated, but the switch for "collection tray forward/backward" does not alter its status.
 Remedy: Check switches, magnetic valves.

6109 PARTS CATCHER ROTATE IN MISSING

Effect: Feed stop, Read in lock
 Meaning: The magnetic valve for "collection tray in/out" was activated, but the switch for "collection tray in/out" does not alter its status.
 Remedy: Check switch, magnetic valve.

6900 USBPLC not available

Cause: USB communication with the safety board could not be established.
 Remedy: Switch the machine off and on again. Please contact the EMCO after-sales service in case the error occurs repeatedly.

6901 Error emergency-off relay USBPLC

Cause: USBPLC EMERGENCY-OFF relay error.
Remedy: Switch the machine off and on again.
Please contact the EMCO after-sales service in case the error occurs repeatedly.

6902 Error standstill monitoring X

Cause: Unauthorized movement of the X axis in the current operating condition.
Remedy: Delete the alarm with the RESET button and switch the machine off and on again.
Please contact the EMCO after-sales service in case the error occurs repeatedly.

6903 Error standstill monitoring Z

Cause: Unauthorized movement of the Z axis in the current operating condition.
Remedy: Delete the alarm with the RESET button and switch the machine off and on again.
Please contact the EMCO after-sales service in case the error occurs repeatedly.

6904 Error alive circuit PLC

Cause: Error in the connection (Watchdog) of the safety board with the PLC.
Remedy: Delete the alarm with the RESET button and switch the machine off and on again. Please contact the EMCO after-sales service in case the error occurs repeatedly.

6906 Error overspeed spindle

Cause: The main spindle speed exceeds the maximum permissible value for the current operating condition.
Remedy: Delete the alarm with the RESET button and switch the machine off and on again. Please contact the EMCO after-sales service in case the error occurs repeatedly.

6907 Error enable pulses ER-module

Cause: ACC-PLC did not shutdown the input/negative feeder-module.
Remedy: Delete the alarm with the RESET button and switch the machine off and on again.
Please contact the EMCO after-sales service in case the error occurs repeatedly.

6908 Error standstill monitoring main drive

Cause: Unexpected warm up of the main spindle in the operating condition.
Remedy: Delete the alarm with the RESET button and switch the machine off and on again.
Please contact the EMCO after-sales service in case the error occurs repeatedly.

6909 Error main drive enable without spindle start

Cause: The release of the control unit of the main spindle was given by the ACC-PLC without the spindle-start key being pressed.
Remedy: Delete the alarm with the RESET button and switch the machine off and on again.
Please contact the EMCO after-sales service in case the error occurs repeatedly.

6910 Error standstill monitoring Y

Cause: Unauthorized movement of the Y axis in the current operating condition.
Remedy: Delete the alarm with the RESET button and switch the machine off and on again.
Please contact the EMCO after-sales service in case the error occurs repeatedly.

6911 Error standstill axes

Cause: Unauthorized movement of the axis in the current operating condition.
Remedy: Delete the alarm with the RESET button and switch the machine off and on again.
Please contact the EMCO after-sales service in case the error occurs repeatedly.

6912 Error overspeed axis

Cause: The feed of the axes exceeds the maximum permissible value for the current operating condition.
Remedy: Delete the alarm with the RESET button and switch the machine off and on again.
Please contact the EMCO after-sales service in case the error occurs repeatedly.

6913 Error overspeed X

Cause: The feed of the X axis exceeds the maximum permissible value for the current operating condition.
Remedy: Delete the alarm with the RESET button and switch the machine off and on again.
Please contact the EMCO after-sales service in case the error occurs repeatedly.

6914 Error overspeed Y

Cause: The feed of the Y axis exceeds the maximum permissible value for the current operating condition.
Remedy: Delete the alarm with the RESET button and switch the machine off and on again.
Please contact the EMCO after-sales service in case the error occurs repeatedly.

6915 Error overspeed Z

Cause: The feed of the Y axis exceeds the maximum permissible value for the current operating condition.

Remedy: Delete the alarm with the RESET button and switch the machine off and on again. Please contact the EMCO after-sales service in case the error occurs repeatedly.

6916 ERROR: X-INDUCTIVE PROXIMITY SWITCH DEFECT

Cause: No signal is delivered by X axis Bero.

Remedy: Delete alarm using the RESET key. If this error reoccurs, contact EMCO.

6917 ERROR: Y-INDUCTIVE PROXIMITY SWITCH DEFECT

Cause: No signal is delivered by Y axis Bero.

Remedy: Delete alarm using the RESET key. If this error reoccurs, contact EMCO.

6918 ERROR: Z-INDUCTIVE PROXIMITY SWITCH DEFECT

Cause: No signal is delivered by Z axis Bero.

Remedy: Delete alarm using the RESET key. If this error reoccurs, contact EMCO.

6919 ERROR: SPINDLE-INDUCTIVE PROXIMITY SWITCH DEFECT

Cause: No signal is delivered by main spindle Bero.

Remedy: Delete alarm using the RESET key. If this error reoccurs, contact EMCO.

6920 INVERSION OF X-DIRECTION TOO LONG "1"

Cause: The change in direction of X axis was being sent to USBSPS for more than three seconds.

Remedy: Delete alarm using the RESET key. Avoid driving back and forth using the manual wheel. If this error reoccurs, contact EMCO.

6921 INVERSION OF Y-DIRECTION TOO LONG "1"

Cause: The change in direction of Y axis was being sent to USBSPS for more than three seconds.

Remedy: Delete alarm using the RESET key. Avoid driving back and forth using the manual wheel. If this error reoccurs, contact EMCO.

6922 INVERSION OF Z-DIRECTION TOO LONG "1"

Cause: The change in direction of Z axis was being sent to USBSPS for more than three seconds.

Remedy: Delete alarm using the RESET key. Avoid driving back and forth using the manual wheel. If this error reoccurs, contact EMCO.

6923 DIFFERENT DOOR-SIGNALS FROM USBPLC AND ACC-PLC

Cause: ACC-PLC and USBSPS receive different door status reports.

Remedy: Delete alarm using the RESET key. If this error reoccurs, contact EMCO.

6924 ERROR ENABLE PULSES MAIN DRIVE

Cause: The pulse release on the main spindle control element was interrupted by the USBSPS, as the PLC did not shut it down in a timely fashion.

Remedy: Cancel alarm with RESET button. If the problem occurs several times, contact EMCO.

6925 GRID PROTECTION ERROR!

Cause: Grid protection does not drop out in current operating state, or does not engage.

Remedy: Clear alarm with emergency off button and restart the machine. Contact EMCO Customer Service if the error occurs on several occasions.

6926 MOTOR PROTECTION ERROR!

Cause: Motor protection drops out in current operating state.

Remedy: Clear alarm with emergency off button and restart the machine. Contact EMCO Customer Service if the error occurs on several occasions.

6927 EMERGENCY OFF ACTIVE ERROR!

Cause: Emergency off button was pressed.

Remedy: Restart the machine.

6928 TOOL CHANGER SHUTDOWN MONITORING ERROR

Cause: Unauthorised tool changer movement in the current operating state.

Remedy: Clear alarm with emergency off button and restart the machine. Contact EMCO Customer Service if the error occurs on several occasions.

6929 MACHINE DOOR CLOSING/LOCKING ERROR

Cause: State of the door lock not plausible or door closure unserviceable.

Remedy: Clear alarm with emergency off button and restart the machine. Contact EMCO Customer Service if the error occurs on several occasions.

6930 BEROS MAIN SPINDLE PLAUSIBILITY ERROR

Cause: Beros main spindle signal different.

Remedy: Clear alarm with emergency off button and restart the machine. Contact EMCO Customer Service if the error occurs on several occasions.

6931 MAIN DRIVE QUICK STOP FUNCTION PLAUSIBILITY ERROR

Cause: Main drive actuator does not confirm the quick stop function in the current operating state.

Remedy: Clear alarm with emergency off button and restart the machine. Contact EMCO Customer Service if the error occurs on several occasions.

6999 USB-EXTENSION FOR ROBOTIK NOT AVAILABLE

Cause: The USB extension for robotics cannot be addressed by ACC.

Remedy: Contact EMCO.

7000: INVALID TOOL NUMBER PROGRAMMED

The tool position was programmed larger than 8. The CNC program will be stopped.

Interrupt program with RESET and correct the program.

7007: FEED HOLD

In the robotic mode a HIGH signal is at input E3.7. Feed Stop is active until a low signal is at E3.7.

7016: SWITCH ON AUXILIARY DRIVES

The auxiliary drives are off. Press the AUX ON key for at least 0.5 sec. (to avoid accidentally switching on) to switch on the auxiliary drives (also a lubricating pulse will be released).

7017: REFERENCE MACHINE

Approach the reference point.

When the reference point is not active, manual movements are possible only with key switch at position "setting operation".

7018: TURN KEY SWITCH

With NC-Start the key switch was in position "setting operation".

NC-Start is locked.

Turn the key switch in the position "automatic" to run a program.

7019: PNEUMATIC LUBRICATION MONITORING!

Refill pneumatic oil

7020: SPECIAL OPERATION MODE ACTIVE

Special operation mode: The machine door is opened, the auxiliary drives are switched on, the key switch is in position "setting operation" and the consent key is pressed.

Manual traversing the axes is possible with open door. Swivelling the tool turret is possible with open door. Running a CNC program is possible only with standing spindle (DRYRUN) and SINGLE block operation.

For safety: If the consent key is pressed for more than 40 sec. the function of this key is interrupted, the consent key must be released and pressed again.

7021: TOOL TURRET NOT LOCKED

The tool turret operating was interrupted.

NC start and spindle start are locked. Press the tool turret key in the RESET status of the control.

7022: COLLECTION DEVICE MONITORING

Time exceed of the swivelling movement.

Check the pneumatics, respectively whether the mechanical system is jammed (possibly a work-piece is jammed).

7023: ADJUST PRESSURE SWITCH !

During opening and closing of the clamping device the pressure switch has to turn off and on once.

Adjust the pressure switch. This alarm does not exist any more for versions starting with PLC 3.10.

7024: ADJUST CLAMPING DEVICE PROXIMITY SWITCH !

When the clamping device is open and the position stop control is active, the respective proximity switch has to feed back that the clamping device is "Open".

Check and adjust the clamping device proximity switch, check the cables.

7025 WAITING TIME MAIN DRIVE !

The LENZE frequency converter has to be separated from the mains supply for at least 20 seconds before you are allowed to switch it on again. This message will appear when the door is quickly opened/ closed (under 20 seconds).

7026 PROTECTION MAIN MOTOR FAN RELEASED!

7038: LUBRICATION SYSTEM FAULT

The pressure switch is defective or gagged. NC-Start is locked. This alarm can be reset only by switching off and on the machine. Contact EMCO service.

7039: LUBRICATION SYSTEM FAULT

Not enough lubricant, the pressure switch is defective. NC-Start is locked. Check the lubricant and lubricate manually or contact EMCO service.

7040: MACHINE DOOR OPEN

The main drive can not be switched on and NC-Start can not be activated (except special operation mode) Close the machine to run a program.

7041: GEARBOX COVER OPEN

The main spindle cannot be switched on and NC start cannot be activated. Close the gearbox cover in order to start a CNC program.

7042: INITIALIZE MACHINE DOOR

Every movement and NC-Start are locked. Open and close the machine door to initialize the safety circuits.

7043: PIECE COUNT REACHED

A predetermined number of program runs was reached. NC-Start is locked. Reset the counter to continue.

7048: CHUCK OPEN

This message shows that the chuck is open. It will disappear if a workpiece will be clamped.

7049: CHUCK - NO PART CLAMPED

No part is clamped, the spindle can not be switched on.

7050: COLLET OPEN

This message shows that the collet is open. It will disappear if a workpiece will be clamped.

7051: COLLET - NO PART CLAMPED

No part is clamped, the spindle can not be switched on.

7052: QUILL IN UNDEFINED POSITION

The tailstock is in no defined position. All axis movements, the spindle and the tool turret are locked. Drive the tailstock in back end position or clamp a workpiece with the tailstock.

7053: QUILL - NO PART CLAMPED

The tailstock reached the front end position. Traverse the tailstock back to the back end position to continue.

7054: NO PART CLAMPED

No part clamped, switch-on of the spindle is locked.

7055: CLAMPING DEVICE OPEN

This message indicates that the clamping device is not in clamping state. It disappears as soon as a part is clamped.

7060 RETRACT SLEEVE LIMIT SWITCH !

The axis arrived in the tailstock sleeve. Drive the travel off the tailstock sleeve.

7061 RETRACT X AXIS LIMIT SWITCH !

The axis arrived to the end switch. Drive the axis off the end switch again.

7062 RETRACT Z AXIS LIMIT SWITCH !

see 7061

7063 OIL LEVEL CENTRAL LUBRICATION !

Low oil level in central lubrication. Refill oil as per maintenance instructions to the machine.

7064 CHUCK GUARD OPEN !

The chuck guard is open. Close the chuck guard.

7065 MOTOR PROTECTION COOLANT PUMP RELEASED !

Overheated coolant pump. Check the coolant pump for ease of motion and presence of dirt. Ensure sufficient amount of coolant fluid in the coolant facility.

7066 CONFIRM TOOL !

To confirm the tool change, press T after the change has been completed.

7067 MANUAL OPERATING MODE

The Special Operation key switch is in the Set position (manual).

7068 X AXIS HANDWHEEL ACTIVE

The safety wheel is locked for manual travel movement. The safety wheel locking is monitored by contactless switches. With the manual wheel locked, the axis feed cannot be switched on. For automatic processing of a program, the manual wheel must be released again.

7069 Y AXIS HANDWHEEL ACTIVE

see 7068

7070 Z AXIS HANDWHEEL ACTIVE

see 7068

7071 VERTICAL TOOL CHANGE

The sheath for manual clamping of the tool holder is monitored by a switch. The switch reports a unaccepted socket wrench or a sheath which was left open. Remove the socket wrench after clamping the tool and close the sheath.

7072 HORIZONTAL TOOL CHANGE

The turning knob for manual tool clamping on the horizontal spindle is monitored by a switch. The switch reports a tightened turning knob. The spindle gets locked. Release the turning knob after clamping the tool.

7073 RETRACT Y AXIS LIMIT SWITCH !

see 7061

7074 CHANGE TOOL

Clamp programmed tool.

7076: SWIVEL UNIT VOR MILLING HEAD UNLOCKED

The milling head is not fully swung. Fix the milling head mechanically (the end switch must be pushed).

7077: ADJUST TOOL TURRET

No valid machine data for tool change are available. Contact EMCO.

7078: POCKET NOT IN HOME POSITION

Cancel during tool change. Swing back tool recessed in setup operation.

7079: TOOL ARM NOT IN HOME POSITION

see 7079

7080: INCORRECT TOOL CLAMPED !

The tool cone lies beyond tolerance. The clamped tool is twisted by 180°. Bero tool clamping is displaced. Check the tool and clamp it again. If this problem occurs with more tools, contact EMCO.

7082: MOTOR PROTECTION CHIP CONVEY-OR RELEASED

The scrap belt is overloaded. Check the conveyor belt for ease of motion and remove jammed scrap.

7083: MAGAZINE IS ACTIVE !

A tool has been removed from the non-chaotic tool administration from the main spindle. Fill the tool drum.

7084: VICE OPEN !

The vice is not clamped. Clamp the vice.

7085 ROUNDAXIS A MOVE TO 0 DEGRE !

Cause: The MOC only shuts down if the A Round axis is at 0°.

When 4.5. is present, a round axis must be made each time before the machine is switched off.

Remedy: Move round axis to 0°.

7088 SWITCHGEAR CABINET OVERHEATING

Cause: Temperature monitoring responded.

Remedy: Check switchgear cabinet filter and fan, raise trigger temperature.

7089 SWITCHGEAR CABINET DOOR OPEN

Cause: Switchgear cabinet door open.

Remedy: Close switchgear cabinet door.

7091 WAIT FOR USB-I2C SPS

Cause: Communication with the USB-I2C PLC could not be established.

Remedy: If the message does not self-extinguish, switch off and on the machine. Please contact EMCO service when the message occurs permanently even after power off.

7092 TEST STOP ACTIVE

Cause: Safety test for monitoring the safety functions is active.

Remedy: Wait until the safety test is finished.

7093 SET REFERENCE POINT

Cause: The reference point acknowledge mode was activated by the operator.

7094 SET X-REFERENCE POINT

Cause: The reference value of the X axis was adopted to the acc.esd file.

7095 SET Y-REFERENCE POINT

Cause: The reference value of the Y axis was adopted to the acc.esd file.

7096 SET Z-REFERENCE POINT

Cause: The reference value of the Z axis was adopted to the acc.esd file.

7097 FEED OVERRIDE 0

Cause: The override switch (feed control) was set by the operator on 0%

7098 SPINDLE-BRAKE 1 ACTIVE

Effect: spindle stop.

7099QUILL DRIVES FORWARD

Effect: Feed stop, Read in lock

Meaning: M21 was programmed → pressure switch "tailstock in front position" is not yet 1.

Remedy: Disappears with pressure switch front position.

7100 QUILL DRIVES BACKWARD

Effect: Feed stop, Read in lock

Meaning: M20 was programmed → limit switch "tailstock back" is not yet 1

Remedy: Disappears with limit switch "backposition".

7101 REFERENCE POINT TOOL TURRET MISSING

Effect: Feed stop, Read in lock

Meaning: At NC start the tool turret is not referenced.

Remedy: Reference tool turret in JOG mode with tool turret key.

7102 TOOL TURRET IN MOTION

Effect: Tool turret swivels to the programmed position.

7103 LIMIT-SWITCH CLAMPING EQUIPMENT 1

Effect: Locking of NC start and main drive start, spindle stop S1

Meaning: The pick-up for the analogue value detects the clamping position as end position.

Remedy: Change clamping range of the clamping device (see "Machine Description - chapter C Programming and Operation").

7104 QUILL IN INTERMEDIATE POSITION

Effect: Feed hold / read in stop.

7105 SET AWZ REFERENCE POINT

Effect: The reference value of the AWZ motor was transferred to the acc.msdc file.

7900 INITIALIZE EMERGENCY OFF!

Cause: The emergency off button must be initialized.

Remedy: Press and then release emergency off button.

7901 INITIALIZE MACHINE DOORS!

Cause: The machine doors must be initialized.

Remedy: Open the machine doors and close them again.

7906 SET A-REFERENCE POINT

Cause: The reference value of the A axis was adopted to the acc.esd file.

Inputunit alarms 1700 - 1899

These alarms and messages are raised by the control keyboard.

1701 Error in RS232

Cause: Serial port settings are invalid or the connection to the serial keyboard were interrupted.

Remedy: Check the settings of the serial interface and/or turn keyboard off/on and check the control cable connection.

1703 Ext. keyboard not available

Cause: Connection with the external keyboard can not be made.

Remedy: Check the settings of the external keyboard and/or check the cable connection.

1704 Ext. keyboard: checksum error

Cause: Error in the transmission.

Remedy: The connection to the keyboard is automatically restored. If this fails, turn off or on the keyboard.

1705 Ext. keyboard: general error

Cause: The attached keyboard reported an error.

Remedy: Plug the keyboard off and on again. Contact EMCO Customer Service if the error occurs on several occasions.

1706 General USB error

Cause: Error in the USB communication.

Remedy: Plug the keyboard off and on again. Contact EMCO Customer Service if the error occurs on several occasions

1707 Ext. Keyboard: no LEDs

Cause: Fehlerhaftes LED-Kommando wurde an die Tastatur gesandt.

Remedy: EMCO-Service kontaktieren.

1708 Ext. Keyboard: unknown command

Cause: Unknown command was sent to the keyboard.

Remedy: Contact EMCO Customer Service

1710 Installation of Easy2control is damaged!

Cause: Incorrect installation of Easy2control

Remedy: Reinstall software and/or contact EMCO Customer Service

1711 Initialization of Easy2Control failed!

Cause: Configuration file onscreen.ini for Easy2control is missing.

Remedy: Reinstall software and/or contact EMCO Customer Service.

1712 License for Easy2control could not be found!

Cause: USB-Dongle or a valid license key for Easy2control is not connected. Easy2control is displayed but can not be operated.

Remedy: Connect USB-Dongle for Easy2control.

1801 Keytable not found!

Cause: The file with the keytable couldn't be found.

Remedy: Reinstall software and/or contact EMCO Customer Service.

1802 Connection to keyboard lost

Cause: Connection to the serial keyboard was interrupted.

Remedy: Turn keyboard off/on and check the cable connection.

Axis Controller Alarms

8000 - 9000, 22000 - 23000, 200000 - 300000

8000 Fatal Error AC

8100 Fatal init error AC

Cause: Internal error

Remedy: Restart software or reinstall when necessary, report to EMCO, if repeatable.

8101 Fatal init error AC

see 8101.

8102 Fatal init error AC

see 8101.

8103 Fatal init error AC

see 8101.

8104 Fatal system error AC

see 8101.

8105 Fatal init error AC

see 8101.

8106 No PC-COM card found

Cause: PC-COM board can not be accessed (ev. not mounted).

Remedy: Mount board, adjust other address with jumper

8107 PC-COM card not working

see 8106.

8108 Fatal error on PC-COM card

see 8106.

8109 Fatal error on PC-COM card

see 8106.

8110 PC-COM init message missing

Cause: Internal error

Remedy: Restart software or reinstall when necessary, report to EMCO, if repeatable.

8111 Wrong configuration of PC-COM

see 8110.

8113 Invalid data (pccom.hex)

see 8110.

8114 Programming error on PC-COM

see 8110.

8115 PC-COM packet acknowledge missing

see 8110.

8116 PC-COM startup error

see 8110.

8117 Fatal init data error (pccom.hex)

see 8110.

8118 Fatal init error AC

see 8110, ev. insufficient RAM memory

8119 PC interrupt no. not valid

Cause: The PC interrupt number can not be used.

Remedy: Find out free interrupt number in the Windows95 system control (allowed: 5,7,10, 11, 12, 3, 4 und 5) and enter this number in WinConfig.

8120 PC interrupt no. unmaskable

see 8119

8121 Invalid command to PC-COM

Cause: Internal error or defective cable

Remedy: Check cables (screw it); Restart software or reinstall when necessary, report to EMCO, if repeatable.

8122 Internal AC mailbox overrun

Cause: Internal error

Remedy: Restart software or reinstall when necessary, report to EMCO, if repeatable.

8123 Open error on record file

Cause: Internal error

Remedy: Restart software or reinstall when necessary, report to EMCO, if repeatable.

8124 Write error on record file

Cause: Internal error

Remedy: Restart software or reinstall when necessary, report to EMCO, if repeatable.

8125 Invalid memory for record buffer

Cause: Insufficient RAM, record time exceeding.

Remedy: Restart software, ev. remove drivers etc. to gain more RAM, reduce record time.

8126 AC Interpolation overrun

Cause: Ev. insufficient computer performance.

Remedy: Set a longer interrupt time in WinConfig. This may result in poorer path accuracy.

8127 Insufficient memory

Cause: Insufficient RAM

Remedy: Close other programs, restart software, ev. remove drivers etc. to gain more RAM.

8128 Invalid message to AC

Cause: Internal error

Remedy: Restart software or reinstall when necessary, report to EMCO, if repeatable.

8129 Invalid MSD data - axisconfig.

see 8128.

8130 Internal init error AC

see 8128.

8130 Internal init error AC

see 8128.

8132 Axis accessed by multiple channels

see 8128.

8133 Insufficient NC block memory AC

see 8128.

8134 Too much center points programmed

see 8128.

8135 No centerpoint programmed

see 8128.

8136 Circle radius too small

see 8128.

8137 Invalid for Helix specified

Cause: Wrong axis for helix. The combination of linear and circular axes does not match.

Remedy: Program correction.

8140 Maschine (ACIF) not responding

Cause: Machine off or not connected.

Remedy: Switch on machine or connect.

8141 Internal PC-COM error

Cause: Internal error

Remedy: Restart software or reinstall when necessary, report to EMCO, if repeatable.

8142 ACIF Program error

Cause: Internal error

Remedy: Restart software or reinstall when necessary, report to EMCO, if repeatable.

8143 ACIF packet acknowledge missing

see 8142.

8144 ACIF startup error

see 8142.

8145 Fatal init data error (acif.hex)

see 8142.

8146 Multiple request for axis

see 8142.

8147 Invalid PC-COM state (DPRAM)

see 8142.

8148 Invalid PC-COM command (CNo)

see 8142.

8149 Invalid PC-COM command (Len)

see 8142.

8150 Fatal ACIF error

see 8142.

8151 AC Init Error (missing RPG file)

see 8142.

8152 AC Init Error (RPG file format)

see 8142.

8153 FPGA program timeout on ACIF

see 8142.

8154 Invalid Command to PC-COM

see 8142.

8155 Invalid FPGA packet acknowledge

see 8142 or hardware error on ACIF board (contact EMCO Service).

8156 Sync within 1.5 revol. not found

see 8142 or Bero hardware error (contact EMCO Service).

8157 Data record done

see 8142.

8158 Bero width too large (referencing)

see 8142 or Bero hardware error (contact EMCO Service).

8159 Function not implemented

Bedeutung: In normal operation this function can not be executed

8160 Axis synchronization lost axis 3..7

Cause: Axis spins or slide is locked, axis synchronisation was lost

Remedy: Approach reference point

8161 X-Axis synchronization lost

Step loss of the step motor. Causes:

- Axis mechanically blocked
- Axis belt defective
- Distance of proximity detector too large (>0,3mm) or proximity detector defective
- Step motor defective

8162 Y-Axis synchronization lost

see 8161

8163 Z-Axis synchronization lost

see 8161

8164 Software limit switch max axis 3..7

Cause: Axis is at traverse area end

Remedy: Retract axis

8168 Software limit overtravel axis 3..7

Cause: Axis is at traverse area end

Remedy: Retract axis

8172 Communication error to machine

Cause: Internal error

Remedy: Restart software or reinstall when necessary, report to EMCO, if repeatable.
Check connection PC - machine, eventually eliminate distortion sources.

8173 INC while NC program is running

Remedy: Stop the program with NC stop or with Reset. Traverse the axis.

8174 INC not allowed

Cause: At the moment the axis is in motion.

Remedy: Wait until the axis stops and then traverse the axis.

8175 MSD file could not be opened

Cause: Internal error

Remedy: Restart software oder bei Bedarf neu installieren, report to EMCO, if repeatable.

8176 PLS file could not be opened

see 8175.

8177 PLS file could not be accessed

see 8175.

8178 PLS file could not be written

see 8175.

8179 ACS file could not be opened

see 8175.

8180 ACS file could not be accessed

see 8175.

8181 ACS file could not be written

see 8175.

8183 Gear too high

Cause: The selected gear step is not allowed at the machine.

8184 Invalid interpolaton command**8185 Forbidden MSD data change**

see 8175.

8186 MSD file could not be opened

see 8175.

8187 PLC program error

see 8175.

8188 Gear command invalid

see 8175.

8189 Invalid channel assignement

see 8175.

8190 Invalid channel within message

see 8175.

8191 Invalid jog feed unit

Cause: The machine does not support the rotation feed in the JOG operating mode.

Remedy: Order a software update from EMCO.

8192 Invalid axis in command

see 8175.

8193 Fatal PLC error

see 8175.

8194 Thread without length

Cause: The programmed target coordinates are identical to the starting coordinates.

Remedy: Correct the target coordinates.

8195 No thread slope in leading axis

Remedy: Program thread pitch

8196 Too many axis for thread

Remedy: Program max. 2 axes for thread.

8197 Thread not long enough

Cause: Thread length too short.

With transition from one thread to the other the length of the second thread must be sufficient to produce a correct thread.

Remedy: Longer second thread or replace it by a linear interpolation (G1).

8198 Internal error (to many threads)

see 8175.

8199 Internal error (thread state)

Cause: Internal error

Remedy: Restart software or reinstall when necessary, report to EMCO, if repeatable.

8200 Thread without spindle on

Remedy: Switch on spindle

8201 Internal thread error (IPO)

see 8199.

8201 Internal thread error (IPO)

see 8199.

8203 Fatal AC error (0-ptr IPO)

see 8199.

8204 Fatal init error: PLC/IPO running

see 8199.

8205 PLC Runtime exceeded

Cause: Insufficient computer performance

8206 Invalid PLC M-group initialisation

see 8199.

8207 Invalid PLC machine data

see 8199.

8208 Invalid application message

see 8199.

8212 Rotation axis not allowed

see 8199.

8213 Circle and rotation axis can't be interpolated**8214 Thread and rotation axis cant't be interpolated****8215 Invalid state**

see 8199.

8216 No rotation axis for rotation axis switch

see 8199.

8217 Axis type not valid!

Cause: Switching during the rotary axis operating mode when the spindle is running.

Remedy: Stop the spindle and switch over to the rotary axis operating mode.

8218 Referencing round axis without selected round axis!

see 8199.

8219 Thread not allowed without spindle encoder!

Cause: Thread cutting, respectively tapping is only possible with spindles with encoders.

8220 Buffer length exceeded in PC send message!

see 8199.

8221 Spindle release although axis is no spindle!

see 8199.

8222 New master spindle is not valid

Cause: The indicated master spindle is not valid when switching over to the master spindle.

Remedy: Correct the spindle number.

8224 Invalid stop mode

see 8199.

8225 Invalid parameter for BC_MOVE_TO_IO!

Cause: The machine is not configured for touch probes. A traversing movement with rotary axis is not allowed during touch probe operating mode.

Remedy: Remove the rotary axis movement from the traversing movement.

8226 Rotary axis switch not valid (MSD data)!

Cause: The indicated spindle does not have a rotary axis.

8228 Rotary axis switch not allowed while axis move!

Cause: The rotary axis has moved during switching over to the spindle operating mode.

Remedy: Stop the rotary axis before switching.

8229 Spindle on not allowed while rotary axis is active!**8230 Program start not allowed due to active spindle rotation axis!****8231 Axis configuration (MSD) for TRANSMIT not valid!**

Cause: Transmit is not possible at this machine.

8232 Axis configuration (MSD) for TRACYL not valid!

Cause: Tracyl is not possible at this machine.

8233 Axis not available while TRANSMIT/TRACYL is active!

Cause: Programming of the rotary axis is not allowed during Transmit/ Tracyl.

8234 Axis control grant removed by PLC while axis interpolates!

Cause: Internal error

Remedy: Delete error with reset and inform EMCO.

8235 Interpolation invalid while axis control grant is off by PLC!

see 8234.

8236 TRANSMIT/TRACYL activated while axis or spindle moves!

see 8234.

8237 Motion through pole in TRANSMIT!

Cause: It is not allowed to move through the coordinates X0 Y0 in Transmit.

Remedy: Alter the traversing movement.

8238 Speed limit in TRANSMIT exceeded!

Cause: The traversing movement gets too close to the coordinates X0 Y0. In order to observe the programmed feed rate, the maximum speed of the rotary axis would have to be exceeded.

Remedy: Reduce the feed rate. Set the value of the C-axis feed limitation in WinConfig, machine data settings / general machine data/ to 0.2. Thus, the feed rate will be automatically reduced near the coordinates X0 Y0.

The distance to the center is calculated with the following formula:

for CT155/CT325/CT450:

$$F[\text{mm/min}] * 0.0016 = \text{distance} [\text{mm}]$$

for CT250:

$$F[\text{mm/min}] * 0.00016 = \text{distance} [\text{mm}]$$

This applies for rapid traverse in transmit:

CT155/250/325: 4200 mm/min

CT450: 3,500 mm/min

8239 DAU exceeded 10V limit!

Cause: Internal error

Remedy: Start the software again or install it anew. Report the error to EMCO.

8240 Function not valid during active transformation (TRANSMIT/TRACYL)!

Cause: The Jog and INC operating mode are not possible during Transmit in X/C and during Tracyl in the rotary axis.

8241 TRANSMIT not enabled (MSD)!

Cause: Transmit is not possible at this machine.

8242 TRACYL not enabled (MSD)!

Cause: Tracyl is not possible at this machine.

8243 Round axis invalid during active transformation!

Cause: It is not allowed to program the rotary axis during Transmit/Tracyl.

8245 TRACYL radius = 0!

Cause: When selecting Tracyl, a radius of 0 was used.

Remedy: Correct the radius.

8246 Offset alignment not valid for this state!

see 8239.

8247 Offset alignment: MSD file write protected!**8248 Cyclic supervision failed!**

Cause: The communication with the machine keyboard is interrupted.

Remedy: Start the software again or install it anew. Report the error to EMCO.

8249 Axis motion check alarm!

see 8239

8250 Spindle must be rotation axis !

see 8239

8251 Lead for G331/G332 missing !

Cause: The threading pitch is missing or the starting coordinates are identical to the target coordinates.

Remedy: Program the threading pitch.
Correct the target coordinates.

8252 Multiple or no linear axis programmed for G331/G332 !

Remedy: Program exactly one linear axis.

8253 Speed value for G331/G332 and G96 missing !

Cause: No cutting speed has been programmed.

Remedy: Program the cutting speed.

8254 Value for thread starting point offset not valid!

Cause: The thread starting point offset is not within the range of 0 to 360°.

Remedy: Correct the thread starting point offset.

8255 Reference point not in valid software limits!

Cause: The reference point has been defined outside the software limit switches.

Remedy: Correct the reference points in WinConfig.

8256 Spindle speed too low while executing G331/G332!

Cause: During tapping the spindle speed has decreased. Perhaps the incorrect threading pitch was used or the core drilling is not correct.

Remedy: Correct the threading pitch. Adapt the diameter to the core drilling.

8257 Real Time Module not active or PCI card not found!

Cause: ACC could not be started correctly or the PCI card in the ACC was not recognized.

Remedy: Report the error to EMCO.

8258 Error allocating Linux data!

see 8257.

8259 Current thread in sequence not valid!

Cause: One block of a thread in sequence has been programmed without thread G33.

Remedy: Correct the program.

8260 Change of leading axis within the thread sequence !

Cause: Occurs if the thread run-out of the longitudinal thread is set so that it's not possible to reach the target point. with the required stopping distance

Remedy: The thread run-out should be at least as large as the pitch. this error also occurs. if the pitch of a thread chain is too large when changing the leading axis.

8261 Missing thread in sequence !

Cause: A successive thread has not been programmed for a thread in sequence, the number has to be in accordance with the SETTHREADCOUNT () that has been defined before.

Remedy: Correct the number of threads in the thread in sequence and add a thread.

8262 Reference marks are not close enough !

Cause: The settings of the linear scale have been changed or the linear scale is defective.

Remedy: Correct the settings. Contact EMCO.

8263 Reference marks are too close together!

see 8262.

8265 No or wrong axis in axis switch command!

Cause: Internal error.

Remedy: Please contact the EMCO after-sales service.

8266 Invalid tool

Cause: Programmed tool is not set in magazine.

Remedy: Correct tool number and/or load tool in magazine.

8267 Speed difference to high

Cause: Die Soll- und Istgeschwindigkeit der Achse weichen zu stark voneinander ab.

Remedy: Run the program again with reduced feed. If this does not remedy the problem, contact EMCO.

8269 USBSPS and ACC speed values or override are different

Cause: USBSPS and ACC have different rotations saved.

Remedy: Delete alarm using the RESET key. If this error reoccurs, contact EMCO.

8270 Reference switch defective

Cause: The reference switch did not switch within the specified range.

Remedy: Cancel alarm with RESET button. If the problem occurs several times, contact EMCO.

8271 Tool load in locked place not possible

Cause: There was an attempt to swing a tool into a locked place in the magazine.

Remedy: Choose a free, unlocked place in the magazine and then swing the tool into the magazine.

8272 Old PLC version, update necessary

Cause: The PLC version is too old to fully support randomised tool management.

Remedy: Update the PLC.

8273 Spindle overload

Cause: The spindle was overloaded and during processing the speed fell (to half of the target speed for more than 500ms).

Remedy: Cancel alarm with RESET button. Change the cut data (feed, speed, infeed).

8274 Define tool before loading

Cause: The tool must be defined in the tool list before it is possible to transfer the tool into the spindle.

Remedy: Create the tool in the tool list, then load.

8275 Could not read position from absolute encoder

Cause: The position of an absolute encoder could not be read.

Remedy: Turn off and on the machine. Contact EMCO service if the error occurs multiple times

8276 Physical axis left the valid travel range

Cause: An axis with absolute encoder is outside the valid range for travel.

Remedy: Turn off and on the machine. Contact EMCO service if the error occurs multiple times.

8277 Sinamics drive package error active

Cause: Error in Sinamics drive.

Remedy: Turn off and on the machine. Contact EMCO service if the error occurs multiple times.

8278 Control not compatible with ACpn

Cause: The WinNC control is incompatible with the ACpn machine.

Remedy: Install a WinNC control which is compatible with the ACpn.

8279 Connection to drive got lost

Cause: the connection between ACpn and CU320 was lost.

Remedy: Turn off and on the machine. Contact EMCO service if the error occurs multiple times

8280 Reference point in setting data not equivalent with machine data, please check!

Cause: The reference point saved in the AC setting data does not match the reference point in the machine data (ACC_MSD).

Remedy: Measure the reference point of all axes anew and enter into EMConfig.

8704 Feed override absent, REPOS is not executed

Cause: The REPOS command is not executed because the feed override is set to 0%.

Remedy: Change the feed override and restart REPOS.

8705 Tool sorting active

Cause: The tools will be re-sorted with random tool management to facilitate non-random operation (tool 1 at place 1, tool 2 at place 2, etc.).

Remedy: Wait until sorting has finished. The controller will delete the report independently.

8706 Check new controller - tool table

Cause: The controller was changed with random tool management active.

Remedy: Check the tool or place table to clear the alarm.

8707 Ending with auxiliary drives switched on not possible

Cause: An attempt was made to end the controller, although the auxiliary drives are still switched on.

Remedy: Switch off the auxiliary drives and then end the controller.

8710 Initiating communication with drives

Cause: ACpn connects to the Sinamics drives

Remedy: Wait until the connection was established.

8712 JOG in X and C deactivated during Transmit

Cause: JOG in X and C is not possible at active Transmit.

22000 Gear change not allowed

Cause: Gear step change when the spindle is active.

Remedy: Stop the spindle and carry out a gear step change.

22270 Feed too high (thread)

Cause: Thread pitch too large / missing, Feed for thread reaches 80% of rapid feed

Remedy: Program correction, lower pitch or lower spindle speed for thread

200000 to 300000 are specific to the drives and show up only in combination with the alarm # "8277 Sinamics error".**201699 - „(F) SI P1 (CU): Test of the shutdown path is necessary“**

Cause: A test of the shutdown path is necessary. The machine remains operational.

Remedy: The test is performed automatically during the next restart of the WinNC.

235014 TM54F: Teststop necessary

Cause: A teststop is necessary.

Remedy: Shutdown and restart the WinNC. The test is performed automatically during restart.

Axis Controller Messages

8700 Execute REPOS in all axes before program start

Cause: After the program was stopped, the axes were manipulated with the hand wheel or with the jog keys and then a restart of the program was attempted.

Remedy: Before starting the program again, one should reposition the axes along the contour by executing "REPOS".

8701 No NCStop during offset align

Cause: The machine is currently executing an automatic offset adjustment. NC stop is not possible at this time.

Remedy: Wait until the offset adjustment is finished and then stop the program with NC stop.

8702 No NCStop during positioning after block search

Cause: The machine is currently finishing the block search operation and then it starts to go back to the last programmed position. No NC stop is possible in the meantime.

Remedy: Wait until positioning is finished and then stop the program with NC stop.

8703 Data record done

The recording of data is finished and the file record.acp has been copied to the installation folder.

8705 Feed-override missing, REPOS will not be executed

Cause: The spindle was overloaded and during processing the speed fell (to half of the target speed for more than 500ms).

Remedy: Cancel alarm with RESET button. Change the cut data (feed, speed, infeed).

8706 Tool sorting active

Cause: The tools were resorted during randomised tool management in order to enable non-randomised operation (tool 1 to place 1, tool 2 to place 2, etc.).

Remedy: Wait till the sorting is finished. The message will be deleted automatically by the control system.

8707 New control - please check tool table

Cause: The control system was changed when randomised tool management was active.

Remedy: Check the tool or place table to cancel the alarm.

8708 Switch off auxiliary drives for shutdown

Cause: There was an attempt to shut down the control system although the auxiliary drives are still switched on.

Remedy: Switch off the auxiliary drives and then shut down the control system.

8709 Insert tool in spindle for loading

Cause: During loading a tool must be physically available in the spindle.

Remedy: Clamp tool in the spindle. The message disappears.

Control alarms 2000 - 5999

The alarms are released by the software.

Fagor 8055 TC/MC
Heidenhain TNC 426
CAMConcept
EASY CYCLE
Sinumerik OPERATE
Fanuc 31i
Heidenhain TNC 640

2200 Syntax error in line %s, column %s

Cause: Syntax error in the program code.

2001 Circle end point invalid

Cause: The start-middle point and middle-end point distances differ by more than 3 µm.

Remedy: Correct circular arc point.

2300 tracyl without corresponding round-axis invalid

Cause: Maybe the machine has no rotary axis.

3000 Traverse feed axis manually to position %s

Remedy: Move the axis manually to the required position.

3001 Tool T.. change!

Cause: A new tool was programmed in the NC program.

Remedy: Clamp the required tool in the machine.

4001 slot width too small

Cause: The tool radius is too large for the slot to be milled.

4002 slot length to small

Cause: The slot length is too small for the slot to be milled.

4003 length equal zero

Cause: Pocket length, pocket width, stud length, stud width are zero.

4004 slot width too big

Cause: The programmed slot width is larger than the slot length.

4005 depth equal zero

Cause: No machining takes place since no effective cutting depth has been defined.

4006 corner radius too big

Cause: The corner radius is too large for the size of the pocket.

4007 diameter too big

Cause: The remaining material (nominal diameter - diameter of the prebore) /2 is larger than the tool diameter.

4008 diameter too small

Cause: The tool diameter is too large for the intended bore.

Remedy: Enlarge the nominal diameter and use a smaller milling cutter.

4009 length too small

Cause: Width and length must be larger than the double tool radius.

4010 diameter less equal zero

Cause: The pocket diameter, the stud diameter, etc. must not be zero.

4011 blank diameter too big

Cause: The diameter of the machined pocket must be larger than the diameter of the premachined pocket.

4012 blank diameter too small

Cause: The diameter of the machined stud must be smaller than the diameter of the premachined stud.

4013 start angle equal to end angle

Cause: Start angle and end angle for hole pattern are identical.

4014 tool radius 0 not permitted

Cause: Tool radius zero is not permitted.

Remedy: Select a valid tool.

4015 no outer contour defined

Cause: The contour file indicated in the cycle was not found.

4017 tool radius too big

Cause: For the programmed machining, a tool being too large was selected. Therefore, machining is not possible.

4018 allowance must not be 0

Cause: There were programmed finishing operations without finishing offset.

4019 too many iterations

Cause: The contour definitions are too complex for the roughing-out cycle.

Remedy: Simplify the contour.

4020 illegal radian correction

Cause: An error has occurred during the programming of the radius compensation.

Remedy: Check the cycle parameters.

4021 can't calculate parallel contour

Cause: The control was not able to calculate the tool radius compensation.

Remedy: Check the programmed contour for plausibility. Maybe contact EMCO.

4022 illegal contour definition

Cause: The programmed contour is not suited to the selected machining.

Remedy: Check the programmed contour.

4024 no contour definition

Cause: The contour file being defined in the cycle has not been found.

4025 internal calculation error

Cause: An unexpected error has occurred during calculation of the cycle movements.

Remedy: Please inform the EMCO after-sales service.

4026 allowance too big

Cause: A part of the finishing offset (for several finishing passes) is larger than the total finishing offset.

Remedy: Correct the finishing offsets.

4028 pitch 0 not permitted

Cause: The thread was programmed with pitch zero.

4029 undefinded working mode

Cause: Internal error (invalid machining type for the thread).

4030 function not yet supported

Cause: Roughing out with pockets is not implemented yet.

Remedy: Please inform the EMCO after-sales service.

4031 value not permitted

Cause: An invalid retracting direction was programmed during inside turning.

4032 plunging must be defined

Cause: For the programmed cycle no cutting depth has been programmed.

4033 radius/chamfer too big

Cause: The radius, respectively the chamfer, cannot be inserted in the programmed contour.

Remedy: Reduce the radius, respectively the chamfer.

4034 diameter too big

Cause: The programmed starting point and the machining diameter are contradictory.

4035 diameter too small

Cause: The programmed starting point and the machining diameter are contradictory.

4036 unknown working direction

Cause: Internal error.

Remedy: Please inform the EMCO after-sales service.

4037 unknown working type

Cause: Internal error.

Remedy: Please inform the EMCO after-sales service.

4038 unknown sub cycle

Cause: Internal error.

Remedy: Please inform the EMCO after-sales service.

4039 rounding not possible

Cause: The programmed radius contradicts the rest of the cycle parameters.

4042 illegal tool width

Cause: The tool width for the cutting-off cycle must be defined.

4043 groove width too small

Cause: Internal error.

Remedy: Please inform the EMCO after-sales service.

4044 distance not defined

Cause: The distance for the multiple grooving cycle must not be zero.

4045 illegal allowance type

Cause: Internal error.

Remedy: Please inform the EMCO after-sales service.

4046 invalid speed

Cause: The spindle speed must be nonzero.

4047 invalid end point

Cause: The programmed end point contradicts the rest of the cycle definition.

4048 tool cut width too small

Cause: The cutting edge is too small for the programmed cutting depth.

4050 invalid distance

Cause: The hole patterns do not tally with the selected distance.

4052 working pattern not possible

Cause: Error in the definition of the hole pattern. The number of bores is contradictory.

4053 invalid start point

Cause: Internal error.

Remedy: Please inform the EMCO after-sales service.

4055 illegal working direction

Cause: The machining direction is contradictory to the rest of the cycle definition.

4057 plunging angle less equal zero

Cause: The plunging angle must be between 0 and 90 degree.

4058 chamfer too large

Cause: The programmed chamfer is too large for the pocket cycle.

4062 radius/chamfer too small

Cause: The radius, respectively the chamfer, cannot be machined with the current tool radius.

4066 invalid mill step

Cause: The mill step must be greater than zero.

4069 invalid angle

Cause: An angle of zero degree is not permitted.

4072 plunging too small

Cause: For the cycle, a cutting depth has been selected that leads to extra-long machining time.

4073 invalid clearance angle

Cause: The clearance angle indicated for the tool cannot be machined.

Remedy: Correct the clearance angle for the tool.

4074 contour-file not found

Cause: The contour file indicated in the cycle has not been found.

Remedy: Please select the contour file for the cycle.

4075 not machinable with selected tool

Cause: The tool is too wide for the programmed groove.

4076 reciprocating plunge cut impossible (initial move too short)

Cause: The first movement of the contour is shorter than the double tool radius and cannot be therefore used for the swinging delivery.

Remedy: Extend the first movement of the contour.

4077 wrong tool type in grooving or cut-off cycle

Cause: The wrong tool type was used in the cutting cycle.

Remedy: Use only grooving and punch tools in the cutting cycles.

4078 radius of helix too small

Cause: The pitch of the helix is ≤ 0 .

Remedy: Program the radius > 0 .

4079 pitch of helix too small

Cause: The radius of the helix is ≤ 0 .

Remedy: Program the pitch > 0 .

4080 radius of helix or tool too large

Cause: The helical approach cannot be executed with the selected data for the helix and the current tool radius without a contour breach.

Remedy: Use a tool with a smaller radius or reduce the radius of the helix.

4200 leaving movement is missing

Cause: No movement after the tool radius compensation was deactivated in the current plane.

Remedy: Insert the departing movement in the current plane after having deactivated the tool radius compensation.

4201 TPC off missing

Cause: The tool radius compensation has not been deactivated.

Remedy: Deactivate the tool radius compensation.

4202 TPC requires at least three movements

Cause: The tool radius compensation requires at least 3 movements in the current plane in order to calculate the tool radius compensation.

4203 approaching movement not possible

Cause: It was not possible to calculate the approaching movement.

4205 leaving movement not possible

Cause: It was not possible to calculate the departing movement.

4208 TPC curve could not be calculated

Cause: It was not possible to calculate the tool radius compensation for the programmed contour.

4209 switching the plane is not allowed when TPC is switched on

Cause: The programmed plane must not be changed during the tool radius compensation.

Remedy: Remove the change of planes during the tool radius compensation.

4210 tool path compensation already activated

Cause: G41 is active and G42 was programmed or G42 is active and G41 was programmed.

Remedy: Switch tool radius compensation off with G40 before programming the radius compensation again.

4211 Bottleneck detected

Cause: In the radius correction calculation some parts of the contour were omitted, as too large a milling cutter tool was used.

Remedy: Use a smaller milling cutting tool to process the contour completely.

4212 Infeed has been programmed twice during approach

Cause: After the approach movement a second infeed has been programmed, without previously moving to the work plane.

Remedy: First program a movement to the work plane before programming a second infeed.

5000 drill manually now**5001 contour has been adjusted to the programmed clearance angle**

Cause: The programmed contour was adapted to the programmed clearance angle. Maybe there will remain rest material that cannot be machined with this tool.

5500 3D simulation: Internal error

Cause: Internal error inside the 3D simulation.

Remedy: Restart the software or, if necessary, report the error to EMCO customer service.

5502 3D simulation: Tool place invalid

Cause: Tool place unavailable on the machine used.

Remedy: Correct tool call-up.

5503 3D simulation: Chuck invalid owing to the unmachined part definition

Cause: The distance from the front of the unmachined part is > the unmachined part length.

Remedy: Change the distance.

5505 3D simulation: Unmachined part definition invalid

Cause: Implausibility in the unmachined part geometry (e.g. expansion in one axis ≤ 0 , inside diameter > outside diameter, unmachined part contour not closed, etc.).

Remedy: Correct unmachined part geometry.

5506 3D simulation: STL chuck file has auto-overcuts

Cause: Error in the chuck description.

Remedy: Correct file.

5507 3D simulation: Pole transit on TRANS-MIT!

Cause: Travel comes too close to the X0 Y0 coordinates.

Remedy: Change travel.

I: Control alarms Sinumerik Operate

Control alarms 10000 - 66000

These alarms will be triggered by the control. These are the same alarms as they would appear on the original Sinumerik Operate control.

10001 Rotation invalid or scaling in the plane different:

Declaration: Coordinates: X0 Y0.

10002 Undefined tool created at magazine place %1, please check!

Declaration: There is a tool in the tool magazine place assignment that was not defined in the control system if it had been processed previously with a different control system. A new tool with the name CHECK_TOOL%1 is generated.

Remedy: Check magazine and change tool name and data.

10003 Active tool %1 cannot be deleted or unloaded.

Declaration: The tool selected for deleting or unloading is active.

Remedy: Select a different tool.

10795 [Channel %1:] Block %2 end point specification during angle programming contradictory

Parameters: %1 = Channel number %2 = Block number, label

Explanation: During programming of a straight line, both positions of the active plane and an angle were specified (the position of the end point is over-specified), or the position of the programmed coordinate cannot be reached with the specified angle. If a contour consisting of two straight lines is to be programmed with angles, it is possible to specify the two axis positions of the plane and an angle in the second block. The error can also occur if, due to a programming error, the preceding block cannot be interpreted as the first subblock of such a contour. A block is interpreted as the first block of a two-block contour if an angle, but not an axis of the active plane, was programmed, and if the block is not already the second block of a contour.

Remedy: Modify part program.

10800 [Channel %1:] Block %3 axis %2 is not a geometry axis

Parameters: %1 = Channel number

%2 = Axis name, spindle number

%3 = Block number, label

Definitions: With an active transformation or a frame with a rotation component the geometry axes are needed for block preparation. If a geometry axis has previously been traversed as positioning axis, it retains its status of "positioning axis" until it is again programmed as a geometry axis. Because of the POSA motion beyond block boundaries, it is not possible to identify in the preprocessing run whether the axis has already reached its target position when the block is executed. This is, however, an unconditional requirement for calculating the ROT component of the frame or of the transformation. If geometry axes are used as positioning axes, then: 1. No rotation may be specified in the current overall frame. 2. No transformation may be selected.

Remedy: After selecting transformation or frame, reprogram the geometry axis now operating as positioning axis (e.g. with WAITP) in order to revert the status to "geometry axis."

10865 [Channel %1:] Block %2 FZ active, but no tool offset, tool %3

Parameters: %1 = Channel number %2 = Axis name, spindle number %3 = Tool

Explanation: For the displayed traversing block a tooth feedrate is active, but no tool offset. Traversing can be performed after the error has been acknowledged. For calculation of the effective feedrate one tooth per revolution will be assumed.

Remedy: Check the NC program for correct tool selection and correct it, if required; then continue the program with NC start. Or: Continue the NC program with NC start. For calculation of the effective feedrate one tooth per revolution is assumed.

B 2013-06

10866 [Channel %1:] Block %2 FZ is active, but the number of teeth of the active D number %4 of tool %3 is zero.

Parameters: %1 = Channel number %2 = Block number, label %3 = Identifier %4 = D number

Explanation: Tooth feedrate is active for the displayed traversing block, but a D number of 0 is selected with \$TC_DPNT (number of teeth). Traversing can be performed after acknowledgement of the error. For calculation of the effective feedrate one tooth per revolution is assumed.

Remedy: Check the NC program for correct tool selection and correct it, if required; then continue the NC program with NC start. Or: Continue the NC program with NC start. The feedrate will be calculated assuming 1 tooth.

10931 [Channel %1:] Block %2 incorrect stock removal contour

Parameters: %1 = Channel number %2 = Block number, label

Definitions: The following errors occurred in the subroutine for the contour during stock removal:

- Full circle
- Overlapping contour elements
- Wrong start position

Remedy: The errors listed above must be corrected in the subroutine for the stock removal contour.

10932 [Channel %1:] Block %2 preparation of contour has been restarted

Parameters: %1 = Channel number %2 = Block number, label

Definitions: The first contour preparation/contour decoding run must be terminated with EXECUTE.

Remedy: Program the keyword EXECUTE to terminate the contour preparation in the part program before again calling up contour segmentation (keyword CONTPRON).

10933 [Channel %1:] Block %2 contour program does not contain enough contour blocks

Parameters: %1 = Channel number %2 = Block number, label

Definitions: The contour program contains:

- Less than 3 contour blocks with CONTPRON
- No contour blocks with CONTDCON

Remedy: Increase the size of the program with the stock removal contour to include at least 3 NC blocks with movements in both axes of the current machining plane.

12150 [Channel %1:] Block %2 operation %3 not compatible with data type

Parameters: %1 = Channel number

%2 = Block number, label

%3 = String (violating operator)

Explanation: The data types are not compatible with the required operation (within an arithmetic expression or in a value assignment).

Example 1:

Arithmetic operation

N10 DEF INT OTTO

N11 DEF STRING[17] ANNA

N12 DEF INT MAX

:

N50 MAX = OTTO + ANNA

Example 2:

Value assignment

N10 DEF AXIS DRILL

N11 DEF INT OTTO

:

N50 OTTO = DRILL

Remedy: Press the NC Stop key and select the function "Correction block" with the softkey PROGRAM CORRECT. The correction pointer positions on the incorrect block.

Alter the definition of the variables used such that the required operations can be executed.

12190 [Channel %1:] Block %2 variable of type ARRAY has too many dimensions

Parameters: %1 = Channel number %2 = Block number, label

Explanation: Array with variables of type STRING may be no more than 1-dimensional, and with all other variables no more than 2-dimensional.

Remedy: Press the NC Stop key and select the function "Correction block" with the softkey PROGRAM CORRECT. The correction pointer positions on the incorrect block. Correct the array definition, with multi-dimensional arrays define a second 2-dimensional array if necessary and operate it with the same field index.

12300 [Channel %1:] Block %2 call-by-reference parameter missing on

subroutine call %3

Parameters: %1 = Channel number

%2 = Block number, label

%3 = Source string

Explanation: In the subroutine definition, a formal REF parameter (call-by-reference parameter) has been specified

with no actual parameter assigned to it.

The assignment takes place in the subroutine call on the basis of the position of the variable name

and not on the basis of the name!

Example:

Subroutine: (2 call-by-value parameters X and Y,
1 call-by-reference parameter Z)

```
PROC XYZ (INT X, INT Y, VAR INT Z)
```

```
:
```

```
M17
```

```
ENDPROC
```

Main program:

```
N10 DEF INT X
```

```
N11 DEF INT Y
```

```
N11 DEF INT Z
```

```
:
```

```
N50 XYZ (X, Y); REF parameter Z missing
```

or

```
N50 XYZ (X, Z) ; REF parameter Z missing!
```

Remedy: Press the NC Stop key and select the function "Correction block" with the softkey PROGRAM CORRECT. The correction pointer positions on the incorrect block. Assign a variable to all REF parameters (call-by-reference parameters) of the subroutine when calling. No variable must be assigned to "normal" formal parameters (call-by-value parameters), as these are defaulted with 0.

12320 [Channel %1:] Block %2 parameter %3 is no variable

Parameters: %1 = Channel number %2 = Block number, label %3 = Source string

Explanation: A constant or the result of a mathematical expression has been assigned to a REF parameter instead of a variable at the time of the subroutine call, even though only variable identifiers are allowed. Examples: N10 XYZ (NAME_1, 10, OTTO) or N10 XYZ (NAME_1, 5 + ANNA, OTTO)

Remedy: Press the NC Stop key and select the function "Correction block" with the softkey PROGRAM CORRECT. The correction pointer positions on the incorrect block. Remove the constant or the mathematical expression from the NC block.

12330 [Channel %1:] Block %2 type of parameter %3 incorrect

Parameters: %1 = Channel number %2 = Block number, label %3 = Source string

Explanation: When calling a procedure (a subroutine) it is found that the type of the actual parameter cannot be converted into the type of the formal parameter. There are two possible cases:

- Call-by-reference parameter: Actual parameter and formal parameter must be of precisely the same type, e.g. STRING, STRING.

- Call-by-value parameter: Actual parameter and formal parameter can in principle be different providing conversion is basically possible. In the present case, however, the types are generally not compatible, e.g. STRING -> REAL.

Overview of type conversions:

- from REAL to: REAL: yes, INT: yes*, BOOL: yes1), CHAR: yes*, STRING: -, AXIS: -, FRAME: -
- from INT to: REAL: yes, INT: yes, BOOL: yes1), CHAR: if value 0 ...255, STRING: -, AXIS: -, FRAME: -
- from BOOL to: REAL: yes, INT: yes, BOOL: yes, CHAR: yes, STRING: -, AXIS: -, FRAME: -
- from CHAR to: REAL: yes, INT: yes, BOOL: yes1), CHAR: yes, STRING: yes, AXIS: -, FRAME: -
- from STRING to: REAL: -, INT: -, BOOL: yes2), CHAR: only if 1 character, STRING: yes, AXIS: -, FRAME: -
- from AXIS to: REAL: -, INT: -, BOOL: -, CHAR: -, STRING: -, AXIS: yes, FRAME: -
- from FRAME to: REAL: -, INT: -, BOOL: -, CHAR: -, STRING: -, AXIS: -, FRAME: yes

1) Value <> 0 corresponds to TRUE, value ==0 corresponds to FALSE.

2) String length 0 => FALSE, otherwise TRUE.

*) At type conversion from REAL to INT fractional values that are >=0.5 are rounded up, others are rounded down.

Remedy: Press the NC Stop key and select the function "Correction block" with the softkey PROGRAM CORRECT. The correction pointer positions on the incorrect block. Check transfer parameters of the subroutine call and define the application accordingly as call-byvalue or call-by-reference-parameter.

12340 [Channel %1:] Block %2 number of parameters too high %3

Parameters: %1 = Channel number %2 = Block number, label %3 = Source string

Explanation: When calling a function or a procedure (predefined or user-defined) more parameters were transferred than defined. Predefined functions and procedures: The number of parameters has been set permanently in the NCK. User-defined functions and procedures: The number of parameters is established by type and name in the definition.

Remedy: Press the NC Stop key and select the function "Correction block" with the softkey PROGRAM CORRECT. The correction pointer positions on the incorrect block. Check whether the correct procedure/function has been called. Program the number of parameters in accordance with the procedure/function.

12360 [Channel %1:] Block %2 dimension of parameter %3 incorrect

Parameters: %1 = Channel number %2 = Block number, label %3 = Source string

Explanation: The following possibilities of error must be checked:

- The current parameter is an array, but the formal parameter is a variable
- The current parameter is a variable, but the formal parameter is an array

Remedy: Press the NC Stop key and select the function "Correction block" with the softkey PROGRAM CORRECT. The correction pointer positions on the incorrect block. Correct the NC part program in accordance with the cause of error as listed above.

12400 [Channel %1:] Block %2 field %3 element does not exist

Parameters: %1 = Channel number %2 = Block number, label %3 = Source string

Explanation: The following causes are possible:

- Impermissible index list; an axis index is missing
- Array index does not match the definition of the variables

- An attempt was made to access a variable at array initialization via SET or REP; this attempt did not correspond to the standard access. Single character access, partial frame access, omitted indices not possible. A non-existent element was addressed on initializing this array.

Remedy: Press the NC Stop key and select the function "Correction block" with the softkey PROGRAM CORRECT. The correction pointer positions on the incorrect block. Array initialization: Check the array index of the addressed element. The 1st array element is given the index [0,0], the 2nd array element [0,1] etc. The right array index (column index) is incremented first. In the 2nd row, the 4th element is also addressed with the index [1,3] (the indices start at zero). Array definition: Check the size of the array. The 1st number indicates the number of elements in the 1st dimension (number of rows), the 2nd number indicates the number of elements in the 2nd dimension (number of columns). An array with 2 rows and 3 columns must be defined by specifying [2,3].

12430 [Channel %1:] Block %2 specified index is invalid

Parameters: %1 = Channel number %2 = Block number, label

Explanation: In specifying an array index (in the array definition) an index was used that is outside the permissible range.

Remedy: Press the NC Stop key and select the function "Correction block" with the softkey PROGRAM CORRECT. The correction pointer positions on the incorrect block. Specify array index within the permissible range. Value range per array dimension: 1 - 32 767.

12470 [Channel %1:] Block %2 G function %3 is unknown

Parameters: %1 = Channel number
%2 = Block number, label
%3 = Source string

Definitions: With indirectly programmed G functions, an invalid or non-allowed group number has been programmed. Allowed group number = 1. and 5 max. number of G groups. In the displayed block, a nondefined G function has been programmed. Only "real" G functions are checked, which begin with the address G, e.g. G555. "Named" G functions such as CSPLINE, BRISK etc. are interpreted as subroutine names.

Remedy: Press the NC Stop key and select the function "Correction block" with the softkey PROGRAM CORRECT. The correction pointer positions on the incorrect block. You should decide on the basis of the machine manufacturer's programming guide whether or not the displayed G function exists or is available, or whether a standard G function has been reconfigured (or introduced by an OEM). Remove G function from the part program or program function call in accordance with the machine manufacturer's programming guide.

12475 [Channel %1:] Block %2 invalid G function number %3 programmed

Parameters: %1 = Channel number
%2 = Block number, label
%3 = G code number

Definitions: A non-allowed G function number (parameter 3) has been programmed for a G group with indirect G code programming. Only the G function numbers indicated in the Programming Guide "Fundamentals", Section 12.3 "List of G functions/Path conditions" are allowed. Alarm display.

Remedy: Modify part program.

12550 [Channel %1:] Block %2 name %3 not defined or option/function not activated

Parameters: %1 = Channel number
%2 = Block number, label
%3 = Source symbol

Explanation: The identifier displayed has not been defined before being used.

_N_SMAC_DEF

_N_MMAL_DEF
 _N_UMAL_DEF
 _N_SGUD_DEF
 _N_MGUD_DEF
 _N_UGUD_DEF

Variable: DEF instruction is missing
 Program: PROC declaration is missing
 The T word cannot be interpreted in ISO mode 2,
 \$MN_EXTERN_DIGITS_TOOL_NO and \$MN_extern_digits_offset_no are 0.

Remedy: Press the NC Stop key and select the function "Compensation block" with the softkey PROGRAM

CORRECT. The cursor positions itself on the incorrect block.

- Correct the name used (writing error)
- Check definitions of variables, subroutines and macros
- Declare subroutine with EXTERN, load subroutine to SPF-Dir
- Check interface definition of subroutine
- Check options. See also MD10711 \$MN_NC_LANGUAGE_CONFIGURATION.

12555 [Channel %1:] Block %2 function not available (identification %3)

Parameters: %1 = Channel number
 %2 = Block number, label
 %3 = Fine ID

Definitions: The identifier has not been defined for this system.

Remedy: Press the NC stop key and select the "Compensation block" function by pressing the "Program correct" softkey. The correction indicator will position in the incorrect block.

- Correct the name used (write error)
- Use a better software system in case of malfunction
- Check the definition of variables, subroutines and macros
- Declare a subroutine with EXTERNAL; load the subroutine to SPF-Dir
- Check the interface definition of the subroutine

12640 [Channel %1:] Block %2 invalid nesting of control structures

Parameters: %1 = Channel number %2 = Block number

Explanation: Error in program run: Opened control structures (IF-ELSE-ENDIF, LOOP-ENDLOOP etc.) are not terminated or there is no beginning of loop for the programmed end of loop. Example: LOOP ENDIF ENDLOOP

Remedy: Correct part program in such a way that all opened control structures are also terminated.

14009 [Channel %1:] Block %2 illegal program path %3

Parameters: %1 = Channel number
 %2 = Block number, label
 %3 = Program path

Definitions: The part program command CALL-PATH was called with a parameter (program path) referring to a directory which does not exist in the file system of the NCK.

Remedy: - Modify the CALLPATH instruction such that the parameter contains the complete path name of the loaded directory.

- Load the programmed directory in the file system of the NCK.

14011[Channel %1:] Block %2 program %3 not existing or will be edited

Parameters:%1 = Channel number%2 = Block number, label%3 = Program name

Explanation: A subroutine call was aborted because the called subroutine could not be opened.The subroutine call can be executed via- subroutine designator - CALL / PCALL / MCALL command- SETINT command- M/T function replacement- event-driven program calls (PROG_EVENT)- selection of a PLC ASUB via PI "_N_ASUP_" and/or FB-4- calling a PLC ASUB via interrupt interface (FC-9)There are various reasons for the alarm:- the subroutine is not in the parts program memory the subroutine- the subroutine is not in the search path (selected directory, _N_SPF_DIR or cycle directories _N_CUS_DIR, _N_CMA_DIR, _N_CST_DIR- the subroutine has not been released or is being edited- faulty absolute path name in subroutine call: Examples of complete path names: /_N_directoryName_DIR/_N_programmName_SPF or /_N_WKS_DIR/_N_wpdName_WPD/_N_programmName_SPF. directoryName: MPF, SPF, CUS, CMA, CST (predefined directories). wpdName: application-specific designator for workpiece directories (max. of 24 signs). programmName: Name of subroutine (max. of 24 signs)- A reload buffer for executing from external was called as subroutine. Note: Unknown designators (string) found in the parts program line by themselves, are interpreted as subroutine calls.

Remedy: Ensure that the subroutine (alarm parameter %3)- is available in the parts program memory- has been released and is not being edited- is available in the search path if not being called via an absolute path name.

14012 [Channel %1:] Block %2 maximum sub-routine level exceeded

Parameters: %1 = Channel number
%2 = Block number, label

Definitions: The maximum nesting depth of 8 program levels has been exceeded.

Subroutines can be called from the main program, and these in turn may have a nesting depth of 7. In interrupt routines the maximum number of levels is 4!

Remedy: Modify the machining program so that the nesting depth is reduced, e.g. using the editor copy a subroutine of the next nesting level into the calling program and remove the call for this subroutine. This reduces the nesting depth by one program level.

14013 [Channel %1:] Block %2 number of subroutine passes invalid

Parameters: %1 = Channel number
%2 = Block number, label

Explanation: In a subroutine call the programmed number of passes P is zero or negative.

Remedy: Program number of passes between 1 and 9 999.

14020 [Channel %1:] Block %2 wrong value or wrong number of parameters on function or procedure call

Parameters: %1 = Channel number %2 = Block number, label

Explanation: - An illegal parameter value was specified in a function or procedure call.

- An illegal number of actual parameters was programmed in a function or procedure call.

Remedy: Modify part program.

14021 [Channel %1:] Block %2 wrong value or wrong number of parameters on function or procedure call

Parameters: %1 = Channel number %2 = Block number, label

Explanation: - An illegal parameter value was specified in a function or procedure call.

- An illegal number of actual parameters was programmed in a function or procedure call.

Remedy: Modify part program.

14080 [Channel %1:] Block %2 jump destination %3 not found

Parameters: %1 = Channel number %2 = Block number, label %3 = Jump destination

Explanation: In conditional and unconditional jumps, the jump destination within the program must be a block with a label (symbolic name instead of block number). If no jump destination has

been found with the given label when searching in the programmed direction, an alarm is output. For parameterizable returns with RET to block number or label, the jump destination within the program must be a block with the block number or label (symbolic name instead of block number). For returns over several levels (parameter 2), the jump destination must be a block within the program level you jumped to. For returns with a string as return destination, the search string must be a name known in the control and the search string must be preceded in the block by a block number and/or a label only.

Remedy: Check NC part program for the following possible errors:

1. Check whether the target designation is identical with the label.
2. Is the jump direction correct?
3. Has the label been terminated with a colon?

14082 [Channel %1:] Block %2 label %3 program section not found

Parameters: %1 = Channel number %2 = Block number, label %3 = Start or end label

Explanation: The start point for repetition of the program part with CALL <program name> BLOCK <start label> TO <end label> has not been found or the same program part repetition has been called recursively.

Remedy: Check the start and end labels for programming repetition in the user program.

14092 [Channel %1:] Block %2 axis %3 is wrong axis type

Parameters: %1 = Channel number
%2 = Block number, label
%3 = Axis name, spindle number

Definitions: One of the following programming errors has occurred:

1. The keyword WAITP(x) "Wait with block change until the specified positioning axis has reached its end point" has been used for an axis that is not a positioning axis.
2. G74 "Reference point approach from the program" has been programmed for a spindle. (Only axis addresses are permitted).
3. The keyword POS/POSA has been used for a spindle. (The keywords SPOS and SPOSA must be programmed for spindle positioning).
4. If the alarm occurs with the "Rigid tapping" function (G331), the following causes are conceivable:
 - The master spindle is not in position-controlled mode.
 - Incorrect master spindle
 - Master spindle without encoder

5. An axis name was programmed which no longer exists (e.g. when using axial variables as an index). Or NO_AXIS has been programmed as an index.

6. If 14092 is output as a note with alarm 20140 Motion-synchronous action: traversing of command axis, the following causes are possible:

- The axis is currently being traversed by the NC program already.

- An overlaid movement is active for the axis.

- The axis is active as following axis of a coupling.

- An interpolation compensation such as a temperature compensation is active for the axis.

Remedy: - Correct the part program according to which of the above errors is involved.

- Program SPOS.

- Set the correct master spindle with SETMS.

14095 [Channel %1:] Block %2 radius for circle programming too small

Parameters: %1 = Channel number %2 = Block number, label

Explanation: The radius entered for radius programming is too small, i.e. the programmed radius is smaller than half of the distance between start and end point.

Remedy: Modify part program.

Clear alarm with NC START or RESET key and continue the program.

14096 [Channel %1:] Block %2 illegal type conversion

Parameters: %1 = Channel number %2 = Block number, label

Explanation: During the program run, a variable value assignment or an arithmetic operation has caused data to be processed in such a way that they have to be converted to another type. This would lead to the value range being exceeded. Value ranges of the various variable types:-
 REAL: Property: Fractional number with dec. pt., value range: +/-(-2-1022-2+1023)-
 INT: Property: Integers with signs, value range: +/-(-231-1)-
 BOOL: Property: Truth value TRUE, FALSE, value range: 0,1-
 CHAR: Property: 1 ASCII character, value range: 0-255-
 STRING: Property: Character string (max. 100 values), value range: 0-255-
 AXIS: Property: Axis addresses, value range: Axis names only-
 FRAME: Property: Geometric information, value range: As for axis paths
 Overview of type conversions:-
 from REAL to: REAL: yes, INT: yes*, BOOL: yes1), CHAR: yes*, STRING: -, AXIS: -, FRAME: --
 from INT to: REAL: yes, INT: yes, BOOL: yes1), CHAR: if value 0 ...255, STRING: -, AXIS: -, FRAME: --
 from BOOL to: REAL: yes, INT: yes, BOOL: yes, CHAR: yes,

STRING: -, AXIS: -, FRAME: --
 from CHAR to: REAL: yes, INT: yes, BOOL: yes1), CHAR: yes, STRING: yes, AXIS: -, FRAME: --
 from STRING to: REAL: -, INT: -, BOOL: yes2), CHAR: only if 1 character, STRING: yes, AXIS: -, FRAME: --
 from AXIS to: REAL: -, INT: -, BOOL: -, CHAR: -, STRING: -, AXIS: yes, FRAME: --
 from FRAME to: REAL: -, INT: -, BOOL: -, CHAR: -, STRING: -, AXIS: -, FRAME: yes1)
 Value <> 0 corresponds to TRUE, value ==0 corresponds to FALSE.
 2) String length 0 => FALSE, otherwise TRUE.
 3) If only 1 character. It is not possible to convert from type AXIS and FRAME nor into type AXIS and FRAME.

Remedy: Modify the program section such that the value range is not exceeded, e.g. by a modified variable def-inition.

14270 [Channel %1:] Block %2 pole programmed incorrectly

Parameters: %1 = Channel number %2 = Block number, label

Explanation: When defining the pole, an axis was programmed that does not belong to the selected processing level. Programming in polar coordinates always refers to the plane activated with G17 to G19. This also applies to the definition of a new pole with G110, G111 or G112.

Remedy: Correct the NC part program. Only the two geometry axes may be programmed that establish the current machining plane.

14280 [Channel %1:] Block %2 polar coordinates programmed incorrectly

Parameters: %1 = Channel number %2 = Block number, label

Explanation: The end point of the displayed block has been programmed both in the polar coordinate system (with AP=..., RP=...) and in the Cartesian coordinate system (axis addresses X, Y,...).

Remedy: Correct the NC part program - the axis motion may be specified in one coordinate system only.

14404 [Channel %1:] Block %2 illegal parameterization of transformation

Parameters: %1 = Channel number %2 = Block number, label

Definitions: Error has occurred when selecting transformation.

Possible causes of error:

- An axis traversed by the transformation has not been enabled:

- is being used by another channel (-> enable)

- is in spindle mode (-> enable with SPOS)

- is in POSA mode (-> enable with WAITP)

- is concurrent Pos axis (-> enable with WAITP)

- Parameterization via machine data has an error
 - Axis or geometry axis assignment to the transformation has an error,
 - Machine data has an error (-> modify machine data, restart) Please note: Any axes not enabled might be signaled via alarm 14092 or alarm 1011 instead of alarm 14404. Transformation-dependent error causes can be in: TRAORI: - TRANSMIT:

- The current machine axis position is unsuitable for selection (e.g. selection in the pole) (-> change position slightly).

- Parameterization via machine data has an error.
 - Special requirement with respect to the machine axis has not been fulfilled (e.g. rotary axis is not a modulo axis) (-> modify machine data, restart).

TRACYL:

The programmed parameter is not allowed when transformation is selected.

TRAANG:

- The programmed parameter is not allowed when transformation is selected.

- Parameterization via machine data has an error.
 - Parameter is faulty (e.g. TRAANG: unfavorable angle value (-> modify machine data, restart)

Persistent transformation:

- Machine data for persistent transformation are wrong (-> consider dependencies, change machine data, restart) Only with active "OEM transformation" compile cycle: The axes included in the transformation must be referenced.

Remedy: Please inform the authorized personnel/service department. Modify part program or machine data. Only with active "OEM transformation" compile cycle: Reference the axes included in the transformation before selecting transformation.

14861 [Channel %1] Block %2 SVC programmed, but no tool offset active

Parameters: %1 = Channel number
 %2 = Block number, label

Explanation: Cutting velocity SVC programmed in the block, but no tool offset active.

Remedy: Select an appropriate tool prior to the SVC instruction.

14862 [Channel %1] Block %2 SVC has been programmed, but the radius of the active tool correction is zero

Parameters: %1 = Channel number
 %2 = Block number, label

Explanation: A cutting velocity SVC has been programmed in the block, but the radius of the active tool offset is zero.

The radius of the active tool offset consists of the offset parameters \$TC_DP6, \$TC_DP12,

\$TC_SCPx6 and \$TC_ECPx6.

Remedy: Select an appropriate tool offset with a positive tool radius prior to the SVC instruction.

14863 [Channel %1] Block %2 The programmed SVC value is zero or negative

Parameters: %1 = Channel number
 %2 = Block number, label

Explanation: The programmed value for the cutting velocity SVC is zero or negative.

Remedy: Program an SVC value larger than zero.

14910 [Channel %1:] Block %2 invalid angle of aperture for programmed circle

Parameters: %1 = Channel number
 %2 = Block number, label

Definitions: When programming a circle by means of the opening angle, a negative opening angle or an opening angle greater than or equal to 360 degrees has been programmed.

Remedy: Program opening angle within the allowed range of values between 0.0001 and 359.9999 [degrees].

16100 [Channel %1:] Block %2 Spindle %3 not available in channel

Parameter: %1 = Channel number
 %2 = Block number, label
 %3 = String

Explanation: Programming incorrect: the spindle number is not recognized in this channel. The alarm can occur in conjunction with dwell time or a spindle function.

Remedy: Please notify the authorized personnel/service. Check parts program to establish whether the programmed spindle number is correct and that the program is running in the right channel. Check MD35000 \$MA_SPIND_ASSIGN_TO_MACHAX for all machine axes to establish whether the programmed spindle number is present in one of them. This machine axis number must be entered in a channel axis of the MD20070 \$MC_AXCONF_MACHAX_USED.

17020 [Channel %1:] Block %2 illegal array index 1

Parameters: %1 = Channel number
 %2 = Block number, label

Explanation: General: Read or write access has been programmed to an array variable with an illegal 1st array index. The valid array indices must lie within the defined array size and the absolute limits (0 - 32,766).

PROFIBUS I/O:

An illegal slot / I/O area index was used while

reading/writing data.

Cause:

1.: Slot / I/O area index >= max. number of available slot / I/O areas.

2.: Slot / I/O area index references a slot / I/O area that has not been configured.

3.: Slot / I/O area index references a slot / I/O area that has not been released for system variables.

The following applies specifically: If the alarm occurs while writing one of the parameters \$TC_MDP1/\$TC_MDP2/\$TC_MLSR, check whether MD18077 \$MN_MM_NUM_DIST_REL_PER_MAGLOC has been set correctly.

MD18077 \$MN_MM_NUM_DIST_REL_PER_MAGLOC defines the number of different Index1 statements that may be made for an Index2 value.

If an MT number is programmed, the value may collide with a previously defined T number or a previously defined magazine number.

Remedy: Correct the specification of array elements in the access instruction to match the defined size. If an SPL is used in Safety Integrated, the field index via optional data may be subject to additional restrictions.

17181 [Channel %1:] Block %2 T no.= %3, D no.= %4 not existing

Parameters: %1 = Channel number %2 = Block number, label %3 = T number %4 = D number

Explanation: A programmed D number was not recognized by the NC. By default, the D number refers to the specified T number. If the flat D number function is active, T= 1 is output.

Remedy: If the program is incorrect, remedy the error with a correction block and continue the program. If the data block is missing, download a data block for the specified T/D values onto the NCK (via HMI with overstore) and continue the program.

17190 [Channel %1:] Block %2 illegal T number %3

Parameters: %1 = Channel number %2 = Block number, label %3 = T number

Explanation: In the displayed block, access is made to a tool that is not defined and therefore not available. The tool has been named by its T number, its name or its name and duplo number.

Remedy: Check tool call in the NC part program:
 - Correct tool number T.. programmed?
 - Tool parameters P1 - P25 defined? The dimensions of the tool edge must have been entered previously either through the operator panel or through the V.24 interface. Description of the system variables \$P_DP x [n, m] n ... Associated tool number T m ... Tool edge number D x ... Parameter number P

17210 [Channel %1:] Block %2 access to variable not possible

Parameters: %1 = Channel number %2 = Block number, label

Explanation: The variable cannot be written/read directly from the part program. It is allowed only in motion synchronous actions. Example for variable: \$P_ACTID (which planes are active) \$AA_DTEPB (axial distance-to-go for reciprocating infeed) \$A_IN (test input) Safety Integrated: Safety PLC system variables can only be read during the safety SPL setup phase.

Remedy: Modify part program.

18310 [Channel %1:] Block %2 frame: illegal rotation

Parameters: %1 = Channel number %2 = Block number, label

Explanation: Rotations are not possible with NCU global frames.

Remedy: Modify part program.

22069 [Channel %1:] Block %2 tool management: No tool available in tool group %3, program %4

Parameters: %1 = Channel number %2 = Block number, label %3 = String (identifier) %4 = Program name

Explanation: The specified tool group does not contain a tool which is ready for use and could be used for tool change. It is possible that all of the tools in question have been set to the 'Disabled' state by the tool monitoring function. Parameter %4 = program name facilitates the identification of the program containing the programming command (tool selection) that caused the error. This can be a subprogram or cycle, etc., which can no longer be identified from the display. If the parameter is not specified, it is the currently displayed program.

Remedy: - Ensure that the specified tool group contains a tool that is ready for use when tool change is requested.

- This can be achieved, for example, by replacing disabled tools, or

- by releasing a disabled tool manually.

- Check whether the tool data are correctly defined. Have all intended tools in the group been defined with the specified identifier and loaded?

61000 %[[Channel %1:] Block %2: %]No tool offset active

Parameters: %1 = Channel number %2 = Block number, label

Explanation: Alarm triggered by following cycles: LONGHOLE, SLOT1, SLOT2, POCKET1 bis POCKET4, CYCLE63, CYCLE64, CYCLE71, CYCLE72, CYCLE90, CYCLE93 through CYCLE96, CYCLE952.

Remedy: D-correction must be programmed before the cycle call.

61001 [Channel %1:] Block %2: Thread pitch incorrectly defined

Parameters: %1 = Channel number
%2 = Block number, label

Explanation: Alarm triggered by following cycles: CYCLE84, CYCLE840, CYCLE96, CYCLE97.

Remedy: Check parameter for the thread size or setting for the pitch (contradict each other)

61002 %[[Channel %1:] Block %2: %]Type of machining incorrectly defined

Parameters: %1 = Channel number %2 = Block number, label

Explanation: The value of the VARI parameter for the machining has been incorrectly specified. Alarm triggered by following cycles: SLOT1, SLOT2, POCKET1 to POCKET4, CYCLE63, CYCLE64, CYCLE71, CYCLE72, CYCLE76, CYCLE77, CYCLE93, CYCLE95, CYCLE97, CYCLE98.

Remedy: Modify VARI parameter.

61003 %[[Channel %1:] Block %2: %]No feed programmed in cycle

Parameters: %1 = Channel number %2 = Block number, label

Explanation: The parameter for the feed has been incorrectly specified. Alarm triggered by following cycles: CYCLE71, CYCLE72.

Remedy: Modify feed parameter.

61005 [Channel %1:] Block %2: 3rd geometry axis not available

Parameters: %1 = Channel number %2 = Block number, label

Explanation: With an application on the lathe with no Y-axis in the G18 plane. Alarm triggered by following cycle: CYCLE86.

Remedy: Check parameter on cycle call.

61006 %[[Channel %1:] Block %2: %]Tool radius too large

Parameters: %1 = Channel number %2 = Block number, label

Explanation: The tool radius is too large for machining. Alarm triggered by following cycles: CYCLE63, CYCLE64, CYCLE930, CYCLE951,

E_CP_CE, E_CP_CO, E_CP_DR, E_PO_CIR, E_PO_REC, F_CP_CE, F_CP_CO, F_CP_DR, F_PO_CIR, F_PO_REC.

Remedy: Select a smaller tool.

61007 [Channel %1:] Block %2: Tool radius too small

Parameters: %1 = Channel number %2 = Block number, label

Explanation: The tool radius is too small for machining. Alarm triggered by following cycles: CYCLE92, E_CP_CO, E_SL_CIR, F_CP_CO, F_PARTOF, F_SL_CIR.

Remedy: Select a larger tool.

61008 [Channel %1:] Block %2: No tool active

Parameters: %1 = Channel number
%2 = Block number, label

Explanation: Alarm triggered by following cycles:

Remedy: Select a tool.

61009 [Channel %1:] Block %2: Active tool number = 0

Parameters: %1 = Channel number %2 = Block number, label

Explanation: No tool (T) has been programmed before the cycle call. Alarm triggered by following cycles: CYCLE71, CYCLE72.

Remedy: Program tool (T).

61010 [Channel %1:] Block %2: Finishing allowance too large

Parameters: %1 = Channel number %2 = Block number, label

Explanation: The finishing allowance for the base is greater than the total depth. Alarm triggered by following cycle: CYCLE72.

Remedy: Reduce finishing allowance.

61011 [Channel %1:] Block %2: Scaling not permissible

Parameters: %1 = Channel number %2 = Block number, label

Explanation: A scale factor is active which is illegal for this cycle. Alarm triggered by following cycles: CYCLE71, CYCLE72.

Remedy: Modify scale factor.

61012 %[[Channel %1:] Block %2: %]Different scaling in planes

Parameters: %1 = Channel number
%2 = Block number, label

Explanation: Alarm triggered by following cycles: CYCLE63, CYCLE64, CYCLE76, CYCLE77.

Remedy: -Clear alarm with the RESET key.

61014 [Channel %1:] Block %2: Return plane exceeded

Parameters: %1 = Channel number
 %2 = Block number, label channel number
Explanation: Alarm triggered by following cycles: CYCLE72.

Remedy: Check parameter RTP.

61016 [Channel %1:] Block %2: System frame for cycles missing

Parameters: %1 = Channel number
 %2 = Block number, label channel number
Explanation: All measuring cycles can trigger this alarm.

Remedy: Set MD 28082: MM_SYSTEM_FRAME_MASK, Bit 5=1.

61017 %[[Channel %1:] Block %2: %]function %4 not present in NCK

Parameters: %1 = Channel number
 %2 = Block number, label channel number
Explanation: Alarm triggered by following cycles:
Remedy: Clear alarm with the RESET key.

61018 [Channel %1:] Block %2: function %4 not executable with NCK

Parameters: %1 = Channel number
 %2 = Block number, label channel number
Explanation: Alarm triggered by following cycles:
Remedy: Clear alarm with the RESET key.

61019 %[[Channel %1:] Block %2: %]Parameter %4 incorrectly defined

Parameters: %1 = Channel number
 %2 = Block number, label channel number
Explanation: Alarm triggered by following cycles: CYCLE60, CYCLE63, CYCLE64, CYCLE83, CYCLE952.

Remedy: Check the value of the parameter. Clear alarm with the RESET key.

61020 [Channel %1:] Block %2: Machining not possible with active TRANSMIT/TRACYL

Parameters: %1 = Channel number
 %2 = Block number, label channel number
Explanation: Alarm triggered by following cycles:
Remedy: Clear alarm with the RESET key.

61021 [Channel %1:] Block %2: Parameter %4 value too high

Parameters: %1 = Channel number
 %2 = Block number, label channel number
Explanation: Alarm triggered by following cycles:
Remedy: Clear alarm with the RESET key.

61022 [Channel %1:] Block %2: Parameter %4 value too low

Parameters: %1 = Channel number
 %2 = Block number, label channel number
Explanation: Alarm triggered by following cycles:
Remedy: Clear alarm with the RESET key.

61023 [Channel %1:] Block %2: Parameter %4 value must be unequal to zero

Parameters: %1 = Channel number %2 = Block number, label channel number
Explanation: Alarm triggered by following cycles:
Remedy: Clear alarm with the RESET key.

61024 [Channel %1:] Block %2: Parameter %4 check value

Parameters: %1 = Channel number
 %2 = Block number, label channel number
Explanation: Alarm triggered by following cycles:
Remedy: Clear alarm with the RESET key.

61025 [Channel %1:] Block %2: Check tool carrier position

Parameters: %1 = Channel number
 %2 = Block number, label channel number
Explanation: Alarm triggered by following cycles:
Remedy: Clear alarm with the RESET key.

61027 %[[Channel %1:] Block %2: %]Subroutine %4 does not exist

Parameters: %1 = Channel number
 %2 = Block number, label
Explanation: Alarm triggered by following cycle: CYCLE62
Remedy: - Check CYCLE62 call
 - Check whether the subroutines specified on CYCLE62 call exist in the program storage

61099 [Channel %1:] Block %2: Internal cycle error (%4)

Parameters: %1 = Channel number
 %2 = Block number, label channel number
Explanation: Alarm triggered by following cycles:
Remedy: Clear alarm with the RESET key.

61101 %[[Channel %1:] Block %2: %]Reference point defined incorrectly

Parameters: %1 = Channel number %2 = Block number, label
Explanation: Alarm triggered by following cycles: CYCLE63, CYCLE64, CYCLE71, CYCLE72, CYCLE81 to CYCLE90, CYCLE840, SLOT1, SLOT2, POCKET1 to POCKET4, LONGHOLE.
Remedy: With an incremental specification of the depth, either different values have to be selected

for the reference point (reference plane) and the retraction plane, or an absolute value must be specified for the depth.

61102 [%1:] Block %2: %1]No spindle direction programmed

Parameters: %1 = Channel number %2 = Block number, label

Explanation: Alarm triggered by following cycles: CYCLE63, CYCLE64, CYCLE86, CYCLE87, CYCLE88, CYCLE840, POCKET3, POCKET4.

Remedy: Parameter SDIR (or SDR in CYCLE840) must be programmed.

61103 [%1:] Block %2: Number of holes is zero

Parameters: %1 = Channel number %2 = Block number, label

Explanation: No value for the number of holes has been programmed. Alarm triggered by following cycles:

HOLES1, HOLES2.

Remedy: Check parameter NUM.

61104 [%1:] Block %2: Contour violation of slots

Parameters: %1 = Channel number %2 = Block number, label

Explanation: Incorrect parameterization of the milling pattern in the parameters which define the position of the slots/elongated holes on the circle and their form. Alarm triggered by following cycles: SLOT1, SLOT2, LONGHOLE.

Remedy: - Clear alarm with the RESET key.

61105 [%1:] Block %2: Milling cutter radius too large

Parameters: %1 = Channel number %2 = Block number, label

Explanation: The diameter of the cutter used is too large for the form to be machined. Alarm triggered by following cycles: SLOT1, SLOT2, POCKET1 to POCKET4, LONGHOLE, CYCLE90.

Remedy: Either a tool with a smaller radius has to be used or the contour must be modified.

61106 [%1:] Block %2: Number of or distance between circular elements

Parameters: %1 = Channel number %2 = Block number, label

Explanation: Incorrect parameterization of NUM or INDA. The layout of the circle elements within a full circle is not possible. Alarm triggered by following cycles: HOLES2, LONGHOLE, SLOT1, SLOT2.

Remedy: Correct parameterization.

61107 [%1:] Block %2: First drilling depth incorrectly defined

Parameters: %1 = Channel number %2 = Block number, label

Explanation: First drilling depth is in the opposite direction to the total drilling depth. Alarm triggered by following cycle: CYCLE83.

Remedy: Modify drilling depth.

61108 [%1:] Block %2: Illegal values for radius and insertion depth parameters

Parameters: %1 = Channel number %2 = Block number, label

Explanation: The radius (_RAD1) and insertion depth (_DP1) parameters for defining the helix path for the depth infeed have been incorrectly specified. Alarm triggered by following cycles: POCKET3, POCKET4.

Remedy: Modify parameter. Clear alarm with the RESET key.

61109 [%1:] Block %2: %1]Milling direction parameter incorrectly defined

Parameters: %1 = Channel number %2 = Block number, label

Explanation: The value of the parameter for the cutting direction _CDIR has been incorrectly defined. Alarm triggered by following cycles: CYCLE63, CYCLE64, POCKET3, POCKET4.

Remedy: - Change milling direction.
- During pocket machining (CYCLE63), the selected milling direction must match the milling direction of centering/rough drilling.

61110 [%1:] Block %2: Finishing allowance at bottom > depth infeed

Parameters: %1 = Channel number %2 = Block number, label

Explanation: The finishing allowance at the base has been specified greater than the maximum depth infeed. Alarm triggered by following cycles: POCKET3, POCKET4.

Remedy: Either reduce finishing allowance or increase depth infeed.

61111 [%1:] Block %2: Infeed width > Tool diameter

Parameters: %1 = Channel number %2 = Block number, label

Explanation: The programmed infeed width is greater than the diameter of the active tool. Alarm triggered by following cycles: CYCLE71,

POCKET3, POCKET4.

Remedy: Infeed width must be reduced.

61112 [Channel %1:] Block %2: Tool radius negative

Parameters: %1 = Channel number %2 = Block number, label

Explanation: The radius of the active tool is negative. This is illegal. Alarm triggered by following cycles: CYCLE72, CYCLE76, CYCLE77, CYCLE90.

Remedy: Change the tool radius.

61113 [Channel %1:] Block %2: Parameter for corner radius too large

Parameters: %1 = Channel number %2 = Block number, label

Explanation: The parameter for the corner radius `_CRAD` has been specified too large. Alarm triggered by following cycle: POCKET3.

Remedy: Reduce corner radius

61114 [Channel %1:] Block %2: Machining direction G41/G42 incorrectly defined

Parameters: %1 = Channel number %2 = Block number, label

Explanation: The machining direction of the cutter radius compensation G41/G42 has been incorrectly selected. Alarm triggered by following cycle: CYCLE72.

Remedy: Change machining direction.

61115 [Channel %1:] Block %2: Approach or retract mode(straight / circle / plane / space) incorrectly defined

Parameters: %1 = Channel number %2 = Block number, label

Explanation: The approach or retract mode to/from the contour has been incorrectly defined. Alarm triggered by following cycle: CYCLE72.

Remedy: Check parameter `_AS1` or `_AS2`.

61116 [Channel %1:] Block %2: Approach or retract path = 0

Parameters: %1 = Channel number %2 = Block number, label

Explanation: The approach or retract path has been specified with zero. Alarm triggered by following cycle: CYCLE72.

Remedy: Check parameter `_LP1` or `_LP2`.

61117 %[[Channel %1:] Block %2: %]Active tool radius <= 0

Parameters: %1 = Channel number %2 = Block number, label

Explanation: The radius of the active tool is negative or zero. Alarm is triggered by the following cycles: CYCLE63, CYCLE71, POCKET3, POCKET4.

Remedy: Modify radius.

61118 [Channel %1:] Block %2: Length or width = 0

Parameters: %1 = Channel number %2 = Block number, label

Explanation: The length or width of the milling area is illegal. Alarm triggered by following cycle: CYCLE71.

Remedy: Check parameters `_LENG` and `_WID`.

61119 [Channel %1:] Block %2: Nominal or core diameter programmed incorrectly

Parameters: %1 = Channel number %2 = Block number, label

Explanation: The nominal or core diameter was incorrectly programmed. Alarm triggered by following cycles: CYCLE70, `E_MI_TR`, `F_MI_TR`.

Remedy: Check thread geometry.

61120 [Channel %1:] Block %2: Thread type inside / outside not defined

Parameters: %1 = Channel number %2 = Block number, label

Explanation: The thread type (internal/external) was not defined. Alarm triggered by following cycles: CYCLE70.

Remedy: The internal/external thread type must be entered.

61121 [Channel %1:] Block %2: Number of teeth per cutting edge is missing

Parameters: %1 = Channel number %2 = Block number, label

Explanation: No value was entered for the number of teeth per cutting edge. Alarm triggered by following cycles: CYCLE70.

Remedy: Enter the number of teeth/cutting edges for the active tool into the tool list.

61124 [Channel %1:] Block %2: Infeed width is not programmed

Parameters: %1 = Channel number %2 = Block number, label

Explanation: Alarm triggered by following cycle: CYCLE71.

Remedy: With active simulation without tool, a value for the infeed width `_MIDA` must always be programmed.

61125 [Channel %1:] Block %2: Technology selection parameter incorrectly defined
Parameters: %1 = Channel number
 %2 = Block number, label
Explanation: Alarm triggered by following cycles: CYCLE84, CYCLE840.
Remedy: Check technology selection parameter (_TECHNO).

61126 [Channel %1:] Block %2: Thread length too short
Parameters: %1 = Channel number
 %2 = Block number, label
Explanation: Alarm triggered by following cycle: CYCLE840.
Remedy: Program lower spindle speed or raise reference point (reference plane).

61127 [Channel %1:] Block %2: Wrong definition of tapping axis transformation ratio (machine data)
Parameters: %1 = Channel number
 %2 = Block number, label
Explanation: Alarm triggered by following cycles: CYCLE84, CYCLE840.
Remedy: Check machine data 31050 and 31060 in the appropriate gear stage of the drilling axis.

61128 [Channel %1:] Block %2: Insertion angle = 0 for insertion with oscillation or helix
Parameters: %1 = Channel number
 %2 = Block number, label
Explanation: Alarm triggered by following cycle: SLOT1.
Remedy: Check parameter _STA2.

61129 [Channel %1:] Block %2: perpendic. approach and retraction during contour milling only allowed with G40
Parameters: %1 = Channel number
 %2 = Block number, label
Explanation: Alarm triggered by following cycle: CYCLE72.
Remedy: Clear alarm with the RESET key.

61150 [Channel %1:] Block %2: Tool cannot be aligned --> error code: %4
Parameters: %1 = Channel number
 %2 = Block number, label
Explanation: Alarm triggered by following cycle: CYCLE800.
Remedy: Causes of error:
 1st error code = A -> only new swivel plane permitted, see parameter _ST

61151 [Channel %1:] Block %2: Orientation of tool not possible --> error code: %4
Parameters: %1 = Channel number
 %2 = Block number, label
Explanation: Alarm triggered by following cycle: CYCLE800.
Remedy: Causes of error:
 1st error code = A -> only additive swivel plane permitted, see parameter _ST

61152 [Channel %1:] Block %2: B axis kinematics (turning technology) either not or incorrectly set up in Start-up of swivel cycle --> error code: %4
Parameters: %1 = Channel number
 %2 = Block number, label
Explanation: Alarm triggered by following cycle: CYCLE800.
Remedy: Causes of error:
 1st error code = A123 -> B axis not an automatic rotary axis under ShopTurn (123 corresponds to parameter _TCBA)
 2nd error code = B123 -> B axis not activated in swiveling start-up (kinematics) (123 corresponds to \$TC_CARR37[n], n ... number of the swivel data record)

61153 [Channel %1:] Block %2: No 'Rotary axes direct' swivel mode possible -> error code: %4
Parameters: %1 = Channel number
 %2 = Block number, label
Explanation: Alarm triggered by following cycle: CYCLE800.
Remedy: Causes of error:
 1st error code = A -> No tool or cutting edge (D1..) active

61154 %[[Channel %1:] Block %2: %]Final depth wrongly programmed
Parameters: %1 = Channel number
 %2 = Block number, label channel number
Explanation: The alarm is triggered by the following cycle: CYCLE63, CYCLE64, CYCLE899
Remedy: Input of end depth possible only absolutely or incrementally

61155 [Channel %1:] Block %2: Unit for plane infeed wrongly programmed
Parameters: %1 = Channel number
 %2 = Block number, label channel number
Explanation: The alarm is triggered by the following cycle: CYCLE899
Remedy: Unit for plane infeed possible only in mm or % of tool diameter

61156 [Channel %1:] Block %2: Depth calculation wrongly programmed

Parameters: %1 = Channel number
 %2 = Block number, label channel number
Explanation: The alarm is triggered by the following cycle: CYCLE899
Remedy: Depth calculation possible only with or without SDIS

61157 %[[Channel %1:] Block %2: %]Reference point wrongly programmed

Parameters: %1 = Channel number
 %2 = Block number, label channel number
Explanation: The alarm is triggered by the following cycle: CYCLE63, CYCLE64, CYCLE899
Remedy: Check reference point in screen form, input only -X, centred or +X

61158 %[[Channel %1:] Block %2: %]Machining plane wrongly programmed

Parameters: %1 = Channel number
 %2 = Block number, label channel number
Explanation: The alarm is triggered by the following cycle: CYCLE63, CYCLE64, CYCLE899, CYCLE952
Remedy: Check machining plane (G17, G18 or G19)

61159 [Channel %1:] Block %2: Machining plane on cycle call differs from the one in the position pattern

Parameters: %1 = Channel number
 %2 = Block number, label channel number
Explanation: The alarm is triggered by the following cycle: CYCLE899
Remedy: Adjust the machining plane on cycle call to the machining plane in the position pattern.

61160 [Channel %1:] Block %2: Residual material remains stationary, reduce plane infeed

Parameters: %1 = Channel number
 %2 = Block number, label channel number
Explanation: The alarm is triggered by the following cycle: CYCLE899
Remedy: Reduce plane infeed or slot width, or use milling cutter with larger diameter

61161 [Channel %1:] Block %2: Centering diameter or tool parameter (diameter, tip angle) are incorrect

Parameters: %1 = Channel number
 %2 = Block number, label channel number
Explanation: The alarm is triggered by the following cycle: CYCLE81
Remedy: - Diameter of centering with tip angle of

active tool not possible
 - Entered workpiece diameter, tool diameter or tip angle of tool incorrect
 - Diameter of tool only has to be entered if centering is to be on workpiece diameter.

61162 [Channel %1:] Block %2: Tool parameter diameter or tip angle incorrect

Parameters: %1 = Channel number
 %2 = Block number, label channel number
Explanation: The alarm is triggered by the following cycle: CYCLE81
Remedy: - The tool parameter diameter or tip angle must be greater than zero
 - Tip angle must be less than 180°

61175 [Channel %1:] Block %2: angle of aperture programmed too small

Parameters: %1 = Channel number %2 = Block number, label
Explanation: The angle of aperture of the text (_DF) in the engraving cycle is too small. This means that the text for engraving does not fit in the specified angle.
Remedy: Enter a larger angle of aperture.

61176 [Channel %1:] Block %2: text length programmed too small

Parameters: %1 = Channel number %2 = Block number, label
Explanation: The text length (_DF) in the engraving cycle is too short. This means that the text for engraving is longer than the specified text length.
Remedy: Enter longer text length

61177 [Channel %1:] Block %2: polar text length > 360 degrees

Parameters: %1 = Channel number
 %2 = Block number, label
Explanation: In the engraving cycle, the polar text length must not exceed 360 degrees.
Remedy: Enter shorter text length.

61178 [Channel %1:] Block %2: code page not present

Parameters: %1 = Channel number
 %2 = Block number, label
Explanation: The specified code page is not supported by the cycle.
Remedy: Use code page 1252.

61179 [Channel %1:] Block %2: character does not exist, no.: %4

Parameters: %1 = Channel number %2 = Block number, label %4 = Character number
Explanation: The character entered in the text

for engraving cannot be milled.
Remedy: Enter another character.

61180 [Channel %1:] Block %2: No name assigned to swivel data record

Parameters: %1 = Channel number %2 = Block number, label

Explanation: Although there are several swivel data blocks, no unique names have been assigned. Alarm triggered by following cycles: CYCLE800.

Remedy: Assign unique name to swivel data block (\$TC_CARR34[n]), if machine data 18088 \$MN_MM_NUM_TOOL_CARRIER is >1.

61181 [Channel %1:] Block %2: NCK software version is insufficient for the Swivel function

Parameters: %1 = Channel number %2 = Block number, label

Explanation: Swivelling is not possible with the current NCK software version. Alarm triggered by following cycles: CYCLE800.

Remedy: Upgrade NCK software to NCK 75.00 or higher.

61182 [Channel %1:] Block %2: Name of swivel data record unknown: %4

Parameters: %1 = Channel number %2 = Block number, label

Explanation: the specified name of the swivel data block is unknown. Alarm triggered by following cycles: CYCLE800.

Remedy: Check name of swivel data record \$TC_CARR34[n].

61183 [Channel %1:] Block %2: Swivel CYCLE800: Retraction mode parameter lies outside value range: %4

Parameters: %1 = Channel number %2 = Block number, label

Explanation: The value of the retraction mode parameter (_FR) lies outside the valid range. Alarm triggered by following cycles: CYCLE800.

Remedy: Swivel CYCLE800: Check transfer parameter _FR. Value range 0 to 8

61184 [Channel %1:] Block %2: No solution possible with current input angle values

Parameters: %1 = Channel number %2 = Block number, label

Explanation: The surface defined via the input angle cannot be processed with the machine. Alarm triggered by following cycles: CYCLE800.

Remedy: -Check the angles entered for swiveling

the machining plane: %4 -Parameter _MODE coding incorrect, e.g. rotation axis-wise YXY

61185 [Channel %1:] Block %2: Invalid angular ranges of rotary axes in swivel data record: %4

Parameters: %1 = Channel number %2 = Block number, label

Explanation: The angular range of the rotary axes is invalid. Alarm triggered by following cycles: CYCLE800. Check setup of the swivel CYCLE800. Parameter \$TC_CARR30[n] to \$TC_CARR33[n] n number of swivel data record Example: Rotary axis 1 modulo 360 degrees: -> \$TC_CARR30[n]=0 \$TC_CARR32[n]=360

Remedy: Check setup of swivel cycle CYCLE800.

61186 [Channel %1:] Block %2: Invalid rotary axis vectors --> Check setup of the swivel cycle CYCLE800.

Parameters: %1 = Channel number %2 = Block number, label

Explanation: No or incorrect entry for rotary axis vector V1 or V2. Alarm triggered by following cycles: CYCLE800.

Remedy: Check setup of swivel CYCLE800 Check rotary axis vector V1: \$TC_CARR7[n], \$TC_CARR8[n], \$TC_CARR9[n] Check rotary axis vector V2: \$TC_CARR10[n], \$TC_CARR11[n], \$TC_CARR12[n] n number of swivel data record

61187 [Channel %1:] Block %2: Check setup of the swivel cycle CYCLE800. --> Error code: %4

Parameters: %1 = Channel number %2 = Block number, label

Explanation: The alarm is triggered by the following cycles: CYCLE800.

Remedy: Error code: See current cycles software version notes in siemens.txt

61188 [Channel %1:] Block %2: No axis name agreed for rotary axis 1 -> Check setup of the swivel cycle CYCLE800.

Parameters: %1 = Channel number %2 = Block number, label

Explanation: No axis name was specified for the rotary axis 1. Alarm triggered by following cycles: CYCLE800.

Remedy: Check setup of swivel CYCLE800. Axis name of rotary axis 1 see parameter \$TC_CARR35[n] n number of swivel data record

61189 [Channel %1:] Block %2: Swivel direct: Invalid rotary axis positions: %4

Parameters: %1 = Channel number
%2 = Block number, label

Explanation: Swivel direct: Check input values of rotary axes. Alarm triggered by following cycles: CYCLE800.

Remedy: Swivel mode direct: Check input values of rotary axes or setup of swivel CYCLE800. Check angular range of rotary axes in swivel data record n: Rotary axis 1: \$TC_CARR30[n], \$TC_CARR32[n] Rotary axis 2: \$TC_CARR31[n], \$TC_CARR33[n]

61190 [Channel %1:] Block %2: Unable to retract prior to swiveling -> Error code: %4

Parameters: %1 = Channel number
%2 = Block number, label

Explanation: See error code for error causes. The alarm is triggered by the following cycles: CYCLE800.

Remedy: Check setup of swiveling CYCLE800. Parameter \$TC_CARR37[n] 7th and 8th decimal place n number of swivel data record
Error code:

- A: Retraction Z not set up
- B: Retraction Z XY not set up
- C: Retraction in tool direction max. not set up
- D: Retraction in tool direction incremental not set up
- E: Retraction in tool direction: NC function CAL-CPOSI reports error
- F: Retraction in tool direction: no tool axis existing
- G: Retraction in tool direction max.: negative retraction path
- H: Retraction in tool direction incremental: negative retraction path
- I: Retraction not possible

61191 [Channel %1:] Block %2: Multi-axis transformation not set up. Error code: %4

Parameters: %1 = Channel number
%2 = Block number, label

Explanation: See error code for error cause. The alarm is triggered by the following cycles: CYCLE800, 832.

Remedy: Error code:
Number or parameter name of multi-axis transformation

61192 [Channel %1:] Block %2: Additional multi-axis transformations not set up. Error code: %4

Parameters: %1 = Channel number
%2 = Block number, label

Explanation: See error code for error cause. The alarm is triggered by the following cycles: CYCLE800, 832.

Remedy: Error code:
Number or parameter name of multi-axis transformation

61193 [Channel %1:] Block %2: compressor option not set up

Parameters: %1 = Channel number
%2 = Block number, label

Explanation: The alarm is triggered by the following cycles: CYCLE832.

Remedy: -Clear alarm with the RESET key.

61194 [Channel %1:] Block %2: spline interpolation option not set up

Parameters: %1 = Channel number
%2 = Block number, label

Explanation: The alarm is triggered by the following cycles: CYCLE832.

Remedy: Clear alarm with the RESET key.

61196 [Channel %1:] Block %2: No swiveling in JOG --> Multi-axis transformations and TCARR activated at the same time

Parameters: %1 = Channel number %2 = Block number, label

Explanation: Multi-axis transformations (TRAORI) and Toolcarrier (TCARR) activated at the same time. Alarm triggered by following cycles: CYCLE800.

Remedy: Deselection of multi-axis transformation with TRAFOOF or deselection of Toolcarrier (TCARR) with CYCLE800()

61199 [Channel %1:] Block %2: Swiveling - tool not allowed -> Error code: %4

Parameters: %1 = Channel number
%2 = Block number, label

Explanation: See error code for error cause. Alarm triggered by following cycles: CYCLE800.

Remedy: Error code:
A: Orientation of tool and change of swivel data record not allowed

61200 [Channel %1:] Block %2: Too many elements in machining block

Parameters: %1 = Channel number %2 = Block number, label

Explanation: The machining block contains too many elements. Alarm triggered by following cycles: CYCLE76, CYCLE77, E_CALL, E_DR, E_DR_BGF, E_DR_BOR, E_DR_O1, E_DR_PEC, E_DR_REA, E_DR_SIN, E_DR_TAP, E_MI_TR, E_PI_CIR, E_PI_REC, E_PO_CIR, E_PO_REC, E_PS_CIR, E_PS_FRA, E_PS_HIN, E_PS_

MRX, E_PS_POL, E_PS_ROW, E_PS_SEQ, E_PS_XYA, E_SL_LON, F_DR, F_DR_PEC, F_DR_REA, F_DR_SIN, F_DR_TAP, F_MI_TR, F_PI_CIR, F_PI_REC, F_PO_CIR, F_PO_REC, F_PS_CIR, F_PS_MRX, F_PS_ROW, F_PS_SEQ, F_SL_LON

Remedy: Check the machining block, delete some elements if required.

61201 [Channel %1:] Block %2: Wrong sequence in machining block

Parameters: %1 = Channel number %2 = Block number, label

Explanation: The sequence of elements in the machining block is invalid. Alarm triggered by following cycles: E_CP_CE, E_CP_DR, E_MANAGE, F_CP_CE, F_CP_DR, F_MANAGE.

Remedy: Sort the sequence in the machining block.

61202 [Channel %1:] Block %2: No technology cycle

Parameters: %1 = Channel number %2 = Block number, label

Explanation: No technology cycle was programmed in the machining block. Alarm triggered by following cycles: E_MANAGE, F_MANAGE.

Remedy: Program a technology block.

61203 [Channel %1:] Block %2: No position cycle

Parameters: %1 = Channel number %2 = Block number, label

Explanation: No positioning cycle was programmed in the machining block. Alarm triggered by following cycles: E_MANAGE, F_MANAGE.

Remedy: Program positioning block.

61204 [Channel %1:] Block %2: Technology cycle unknown

Parameters: %1 = Channel number %2 = Block number, label

Explanation: The specified technology cycle in the machining block is unknown. Alarm triggered by following cycles: E_MANAGE, F_MANAGE.

Remedy: Delete and reprogram the technology block.

61205 [Channel %1:] Block %2: Position cycle unknown

Parameters: %1 = Channel number %2 = Block number, label

Explanation: The specified positioning cycle in the machining block is unknown. Alarm triggered by following cycles: E_MANAGE, F_MANAGE.

Remedy: Delete and reprogram the positioning block.

61210 [Channel %1:] Block %2: Block search element not found

Parameters: %1 = Channel number %2 = Block number, label

Explanation: The element specified for the block search does not exist. Alarm triggered by following cycles: E_MANAGE, E_PS_CIR, E_PS_MRX, E_PS_POL, E_PS_SEQ, E_PS_XYA, F_MANAGE, F_PS_CIR, F_PS_MRX, F_PS_SEQ

Remedy: Repeat block search.

61211 [Channel %1:] Block %2: Absolute reference missing

Parameters: %1 = Channel number %2 = Block number, label

Explanation: An incremental indication was made, but the absolute reference is unknown. Alarm triggered by following cycles: E_MI_CON, E_MI_PL, E_PI_CIR, E_PI_REC, E_PO_CIR, E_PO_REC, E_PS_CIR, E_PS_HIN, E_PS_MRX, E_PS_POL, E_PS_SEQ, E_PS_XYA, E_SL_CIR, E_SL_LON, F_PS_CIR, F_PS_MRX, F_PS_SEQ

Remedy: Program an absolute position prior to using incremental indications.

61212 %[[Channel %1:] Block %2: %]Wrong tool type

Parameters: %1 = Channel number %2 = Block number, label

Explanation: The tool type is not suitable for machining. Alarm triggered by following cycles: CYCLE63, CYCLE64, CYCLE92, CYCLE951, CYCLE952, E_DR, E_DR_O1, E_DR_PEC, E_DR_SIN, E_MI_TXT, F_DR, F_DR_PEC, F_DR_SIN, F_DRILL, F_DRILLC, F_DRILLD, F_DRM_DR, F_DRM_PE, F_DRM_SI, F_GROOV, F_MI_TXT, F_MT_LEN, F_PARTOF, F_ROU_Z, F_ROUGH, F_SP_EF, F_TAP, F_TR_CON, F_UCUT_T

Remedy: Select a new tool type.

61213 [Channel %1:] Block %2: Circle radius too small

Parameters: %1 = Channel number %2 = Block number, label

Explanation: The programmed circle radius is too small. Alarm triggered by following cycles: CYCLE77, E_CR_HEL, E_PI_CIR, E_PO_CIR, E_PO_REC, F_PI_CIR, F_PO_CIR, F_PO_REC

Remedy: Correct the circle radius, center point or end point.

61214 [Channel %1:] Block %2: No pitch programmed

Parameters: %1 = Channel number %2 = Block number, label

Explanation: No thread/helical pitch has been entered. Alarm triggered by following cycles: E_CR_HEL, E_PO_CIR, E_PO_REC, F_PO_CIR, F_PO_REC.

Remedy: Program a pitch.

61215 [Channel %1:] Block %2: Unfinished dimension incorrectly programmed

Parameters: %1 = Channel number %2 = Block number, label

Explanation: Check the blank spigot dimensions. The blank spigot must be larger than the production part spigot. Alarm triggered by following cycles: CYCLE76, CYCLE77, E_PI_CIR, E_PI_REC, E_PO_CIR, E_PO_REC, F_PI_CIR, F_PI_REC, F_PO_CIR, F_PO_REC

Remedy: Check parameters _AP1 and _AP2.

61216 %[[Channel %1:] Block %2: %]Feed/tooth only possible with cutting tools

Parameters: %1 = Channel number %2 = Block number, label

Explanation: Feed per tooth is only possible with milling tools. Alarm triggered by following cycles: E_TFS, F_TFS.

Remedy: As alternative, set a different feed type.

61217 [Channel %1:] Block %2: Cutting speed programmed for tool radius 0

Parameters: %1 = Channel number %2 = Block number, label

Explanation: To be able to work with cutting speed, the tool radius has to be specified. Alarm triggered by following cycles: E_DR_SIN, E_DR_TAP, E_TFS, F_DR_SIN, F_DR_TAP, F_DRILLC, F_DRM_TA, F_TAP, F_TFS

Remedy: Enter a value for cutting speed.

61218 [Channel %1:] Block %2: Feed/tooth programmed, but number of tools equals zero

Parameters: %1 = Channel number %2 = Block number, label

Explanation: For feed per tooth, the number of teeth has to be specified. Alarm triggered by following cycles: E_TFS, E_DR_BGF, F_TFS.

Remedy: Enter the number of teeth on the milling tool in the "Tool list" menu.

61220 [Channel %1:] Block %2: Tool radius too small

Parameters: %1 = Channel number %2 = Block number, label

Explanation: The tool radius is too small for machining. Alarm triggered by following cycles: CYCLE78.

Remedy: Select a suitable tool.

61221 [Channel %1:] Block %2: No tool active

Parameters: %1 = Channel number %2 = Block number, label

Explanation: No tool active.

Remedy: Select a suitable tool.

61222 [Channel %1:] Block %2: Plane infeed greater than tool diameter

Parameters: %1 = Channel number %2 = Block number, label

Explanation: The plane infeed must not be greater than the tool diameter. Alarm triggered by following cycles: CYCLE79, , E_MI_PL, E_PO_CIR, E_PO_REC, F_PO_CIR, F_PO_REC.

Remedy: Reduce plane infeed.

61223 [Channel %1:] Block %2: Approach path too small

Parameters: %1 = Channel number %2 = Block number, label

Explanation: The approach path must not be less than zero. Alarm triggered by following cycles: E_MI_CON, F_MI_CON.

Remedy: Enter a greater value for the approach path.

61224 [Channel %1:] Block %2: Retract path too small

Parameters: %1 = Channel number %2 = Block number, label

Explanation: The retract path must not be less than zero. Alarm triggered by following cycles: E_MI_CON, F_MI_CON.

Remedy: Enter a greater value for the retract path.

61225 [Channel %1:] Block %2: Swivel data record unknown

Parameters: %1 = Channel number %2 = Block number, label

Explanation: An attempt was made to access a swivel data block which has not been defined. Alarm triggered by following cycles: E_TCARR, F_TCARR.

Remedy: Select another swivel data block or define a new swivel data block.

61226 [Channel %1:] Block %2: Inclinable head cannot be exchanged

Parameters: %1 = Channel number %2 = Block number, label

Explanation: The parameter "Swivel data block" is set to "No". In spite of this, an attempt has been made to change the swivel head. Alarm triggered by following functions: E_TCARR, F_TCARR.

Remedy: Set the parameter "Swivel data block" in the setup screen "Rotary axes" to "Automatic" or "Manual".

61231 [Channel %1:] Block %2: ShopMill program %4 not executable, as not tested by ShopMill

Parameters: %1 = Channel number %2 = Block number, label %4 = Program name

Explanation: Before a ShopMill program can be executed, it has to be tested by ShopMill. Alarm triggered by following cycle: E_HEAD.

Remedy: The program first has to be simulated in ShopMill or loaded into the operating mode "Machine auto" by ShopMill.

61232 [Channel %1:] Block %2: Impossible to load magazine tool

Parameters: %1 = Channel number %2 = Block number, label

Explanation: Only manual tools may be loaded into a swivel head in which only manual tools can be loaded. The alarm is triggered by the following cycles: E_TD, E_TFS, F_TFS

Remedy: Load a manual tool into the swivel head or set the parameter "Tool change" on the setup screen form "Rotary axes" to "Automatic".

61233 [Channel %1:] Block %2: Thread angle wrongly defined

Parameters: %1 = Channel number %2 = Block number, label

Explanation: The thread angles were specified too large or too small. Alarm triggered by following cycles: E_TR_CON, F_TR_CON

Remedy: Check thread geometry.

61234 [Channel %1:] Block %2: ShopMill subroutine %4 cannot be executed, as not tested by ShopMill

Parameters: %1 = Channel number %2 = Block number, label %4 = Subroutine name

Explanation: Before a ShopMill subroutine can be used, it has to be tested by ShopMill. Alarm triggered by following cycle: E_HEAD.

Remedy: The subroutine first has to be simulated in ShopMill or loaded into the ShopMill operating mode "Machine auto".

61235 [Channel %1:] Block %2: ShopTurn program %4 cannot be executed as not tested by ShopTurn.

Parameters: %1 = Channel number %2 = Block number, label %4 = Program name

Explanation: Before a ShopTurn program can be executed, it has to be tested by ShopTurn. Alarm triggered by following cycle: F_HEAD

Remedy: Simulate the subroutine first in ShopTurn or load it into the ShopTurn operating mode "Machine auto".

61236 [Channel %1:] Block %2: ShopTurn subroutine %4 cannot be executed as not tested by ShopTurn.

Parameters: %1 = Channel number %2 = Block number, label %4 = Subroutine name

Explanation: Before a ShopTurn subroutine can be used, it has to be tested by ShopTurn. Alarm triggered by following cycle: F_HEAD.

Remedy: Simulate the subroutine first in ShopTurn or load it into the ShopTurn operating mode "Machine auto".

61237 [Channel %1:] Block %2: Retraction direction unknown. Withdraw tool manually!

Parameters: %1 = Channel number %2 = Block number, label

Explanation: The tool is in the retraction area and it is unknown in which direction it can be travelled out of it. Alarm triggered by following cycle: F_SP_RP

Remedy: Manually retract the tool from the retraction area defined in the program header and restart the program.

61238 [Channel %1:] Block %2: Machining direction unknown!

Parameters: %1 = Channel number %2 = Block number, label

Explanation: The direction of the next machining is unknown. Alarm triggered by following cycle: F_SP_RP.

Remedy: Please contact the responsible Siemens regional office.

61239 [Channel %1:] Block %2: Tool change point lies within retraction area!

Parameters: %1 = Channel number %2 = Block number, label

Explanation: The tool change point has to be far enough outside the retraction area so that when the revolver is swiveled, no tool extends into the retraction area. The alarm is triggered by the following cycle: F_SP_RP

Remedy: Specify another tool change point.

61240 [Channel %1:] Block %2: %]Wrong feed type

Parameters: %1 = Channel number %2 = Block number, label

Explanation: The feed type is not possible for this machining. Alarm triggered by following cycles: F_DRM_DR, F_DRM_PE, F_DRM_RE, F_DRM_SI, F_GROOV, F_MIM_TR, F_ROUGH, F_SP_EF, F_UCUT_T, CYCLE952

Remedy: Check feed type

61241 [Channel %1:] Block %2: Retraction plane not defined for this machining direction

Parameters: %1 = Channel number %2 = Block number, label

Explanation: No retraction plane has been defined for the selected machining direction. Alarm triggered by following cycles: F_SP_RP, F_SP_RPT.

Remedy: Define the missing retraction plane.

61242 [Channel %1:] Block %2: Wrong machine direction

Parameters: %1 = Channel number %2 = Block number, label

Explanation: The machining direction has been specified incorrectly. Alarm triggered by following cycles: F_DR, F_DR_PEC, F_DR_REA, F_DR_SIN, F_DR_TAP, F_DRILL, F_DRILLC, F_DRILLD, F_DRM_DR, F_DRM_PE, F_DRM_RE, F_DRM_SI, F_DRM_TA, F_MI_CON, F_MI_EDG, F_MI_TR, F_MI_TXT, F_MIM_TR, F_PI_CIR, F_PI_REC, F_PO_CIR, F_PO_REC, F_SL_CIR, F_SL_LON, F_TAP.

Remedy: Check the programmed machining direction.

61243 [Channel %1:] Block %2: Correct tool change point, tool tip in

Parameters: %1 = Channel number %2 = Block number, label

Explanation: The tool change point must be situated so far outside the retraction area that no tool protrudes into the retraction area on turret swiveling. Alarm triggered by following cycle: F_SP_RP

Remedy: Specify another tool change point.

61244 [Channel %1:] Block %2: Pitch change causing

Parameters: %1 = Channel number %2 = Block number, label

Explanation: The specified pitch change causes a reversal of the thread direction. Alarm triggered by following cycle: CYCLE99

Remedy: Check thread pitch change and thread geometry.

61246 [Channel %1:] Block %2: Safety distance too small

Parameters: %1 = Channel number %2 = Block number, label

Explanation: The safety clearance is too small for machining. Alarm triggered by following cycle: CYCLE79.

Remedy: Increase safety clearance.

61247 [Channel %1:] Block %2: Blank radius too small

Parameters: %1 = Channel number %2 = Block number, label

Explanation: The blank radius is too small for machining. Alarm triggered by following cycle: CYCLE79.

Remedy: Increase blank radius.

61248 [Channel %1:] Block %2: Infeed too small

Parameters: %1 = Channel number %2 = Block number, label

Explanation: The infeed is too small for machining. Alarm triggered by following cycle: CYCLE79.

Remedy: Increase infeed.

61249 [Channel %1:] Block %2: Number of edges too small

Parameters: %1 = Channel number %2 = Block number, label

Explanation: The number of edges is too small. Alarm triggered by following cycle: CYCLE79.

Remedy: Increase number of edges.

61250 [Channel %1:] Block %2: Width across flats/edge length too small

Parameters: %1 = Channel number %2 = Block number, label

Explanation: The width across flats/edge length is too small. Alarm triggered by following cycle: CYCLE79.

Remedy: Increase key width/edge length.

61251 [Channel %1:] Block %2: Width across flats/edge length too large

Parameters: %1 = Channel number %2 = Block number, label

Explanation: The width across flats/edge length is too large. Alarm triggered by following cycle: CYCLE79.

Remedy: Decrease key width/edge length.

61252 [Channel %1:] Block %2: Chamfer/radius too large

Parameters: %1 = Channel number %2 = Block number, label

Explanation: Chamfer/radius is too large. Alarm triggered by following cycle: CYCLE79.
Remedy: Decrease chamfer/radius.

61253 [Channel %1:] Block %2: No finishing allowance programmed

Parameters: %1 = Channel number %2 = Block number, label
Explanation: No finishing allowance has been entered. Alarm triggered by following cycles: E_PO_CIR, E_PO_REC, E_SL_CIR, E_SL_LON, F_PO_CIR, F_PO_REC, F_SL_CIR, F_SL_LON.
Remedy: Programm a finishing allowance.

61254 [Channel %1:] Block %2: Error while traveling to fixed stop

Parameters: %1 = Channel number %2 = Block number, label
Explanation: Error on travelling to fixed stop. Alarm triggered by following cycle: F_SUB_SP.
Remedy: specify another Z1 position for gripping the counterspindle.

61255 [Channel %1:] Block %2: Error during cut-off: Tool broken?

Parameters: %1 = Channel number %2 = Block number, label
Explanation: Cut-off could not be completed. A tool breakage might have occurred. Alarm triggered by following cycles: F_PARTOF, F_SUB_SP.
Remedy: Check the tool.

61256 [Channel %1:] Block %2: Mirroring not allowed at program start. Deselect work offset!

Parameters: %1 = Channel number %2 = Block number, label
Explanation: Mirroring impermissible at program start. Alarm triggered by following cycle: F_HEAD.
Remedy: Deselect work offset.

61257 [Channel %1:] Block %2: incomplete setup of counterspindle

Parameters: %1 = Channel number %2 = Block number, label
Explanation: Setup of the counterspindle is incomplete. Alarm triggered by following cycle: F_SUB_SP.
Remedy: The following machine and setting data must be set for the counterspindle:
 - MD52206 \$MCS_AXIS_USAGE
 - SD55232 \$SCS_SUB_SPINDLE_REL_POS
 - SD55550 \$SCS_TURN_FIXED_STOP_DIST
 - SD55551 \$SCS_TURN_FIXED_STOP_FEED
 - SD55552 \$SCS_TURN_FIXED_STOP_FORCE

61258 [Channel %1:] Block %2: Assign parameters for counterspindle chuck in the spindle chuck data

Parameters: %1 = Channel number %2 = Block number, label
Explanation: The parameters for the counterspindle chuck in the spindle chuck data have not been assigned. The alarm is triggered by the following cycles: F_SUB_SP.
Remedy: Indicate parameters ZCn, ZSn and ZEn in the mask "Parameters" > "Setting data" > "Spindle chuck data".

61261 [Channel %1:] Block %2: center offset too large

Parameters: %1 = Channel number %2 = Block number, label
Explanation: The center offset on center drilling is larger than permissible. Alarm triggered by following cycles: F_DRILL, F_DRILLD.
Remedy: Enter smaller center offset (see display machine data 9862).

61263 [Channel %1:] Block %2: Chained ShopMill program blocks not permissible in subprogram on pos. pattern

Parameters: %1 = Channel number %2 = Block number, label
Explanation: If a subroutine is called from a position pattern, the subroutine itself must not include a position pattern. The alarm is triggered by the following cycle: E_MANAGE
Remedy: Reprogram machining.

61265 [Channel %1:] Block %2: Too many restrictions, use rectangular pocket

Parameters: %1 = Channel number %2 = Block number, label
Explanation: In face milling a maximum of only 3 sides can be delimited. Alarm triggered by following cycle: CYCLE61
Remedy: Use pocket cycle.

61266 [Channel %1:] Block %2: Illegal machining direction

Parameters: %1 = Channel number %2 = Block number, label
Explanation: In face milling, the delimitations and the direction of machining do not match. Alarm triggered by following cycle: CYCLE61
Remedy: Select another direction of machining.

61267 [Channel %1:] Block %2: Plane infeed too large, residual corners remain

Parameters: %1 = Channel number %2 = Block number, label

Explanation: In face milling, the plane infeed must not exceed 85%. Alarm triggered by following cycle: CYCLE61

Remedy: Select a smaller plane infeed, as otherwise residual corners will be left over.

61268 [Channel %1:] Block %2: Illegal machining direction, residual corners are left over.

Parameters: %1 = Channel number %2 = Block number, label

Explanation: In face milling, the machining direction does not match the selected delimitations. Alarm triggered by following cycle: CYCLE61.

Remedy: The machining direction must be selected to match the delimitations.

61269 [Channel %1:] Block %2: External tool diameter too small

Parameters: %1 = Channel number %2 = Block number, label

Explanation: Incorrect tool definition. Alarm triggered by following cycle: CYCLE61.

Remedy: Check angle and diameter of the tool used.

61270 %[[Channel %1:] Block %2: %]Chamfer width too small

Parameters: %1 = Channel number %2 = Block number, label

Explanation: Chamfer width selected too small. Alarm triggered by the following cycles: E_SP_CHA, F_SP_CHA.

Remedy: Increase the chamfer width.

61271 %[[Channel %1:] Block %2: %]Chamfer width > tool radius

Parameters: %1 = Channel number %2 = Block number, label

Explanation: Chamfer width larger than tool radius. Alarm triggered by following cycles: E_SP_CHA, F_SP_CHA.

Remedy: Use a larger tool.

61272 %[[Channel %1:] Block %2: %]Insertion depth too small

Parameters: %1 = Channel number %2 = Block number, label

Explanation: Insertion depth on chamfering too small. Alarm triggered by following cycles: E_SP_CHA, F_SP_CHA.

Remedy: Increase the insertion depth.

61273 %[[Channel %1:] Block %2: %]Insertion depth too large

Parameters: %1 = Channel number %2 = Block number, label

Explanation: Insertion depth on chamfering too large. Alarm triggered by following cycles: E_SP_CHA, F_SP_CHA.

Remedy: Decrease the insertion depth.

61274 %[[Channel %1:] Block %2: %]Invalid tool angle

Parameters: %1 = Channel number %2 = Block number, label

Explanation: Invalid tool angle. Alarm triggered by following cycles: E_SP_CHA, F_SP_CHA.

Remedy: Check tool angle

61275 [Channel %1:] Block %2: Target point violates software limit switch!

Parameters: %1 = Channel number %2 = Block number, label

Explanation: Due to a swivel action, the end point is outside the software limit switches. Alarm triggered by following cycle: E_SP_RP.

Remedy: Select another retraction plane or approach a suitable interpolation point.

61276 [Channel %1:] Block %2: External tool diameter required for restrictions

Parameters: %1 = Channel number %2 = Block number, label

Explanation: Outer tool diameter required in case of delimitations. Alarm triggered by following cycle: CYCLE61.

Remedy: Specify the outer tool diameter.

61277 [Channel %1:] Block %2: Tool diameter larger than restriction

Parameters: %1 = Channel number %2 = Block number, label

Explanation: Tool diameter larger than delimitation. Alarm triggered by following cycle: CYCLE61.

Remedy: Use a smaller tool.

61278 [Channel %1:] Block %2: If tool angle is larger than 90°, both tool diameters must be equal

Parameters: %1 = Channel number %2 = Block number, label

Explanation: For tool angles larger than 90°, the two tool diameters must be identical. Alarm triggered by following cycle: CYCLE61.

Remedy: Correct the tool angle or the tool diameters.

61279 [Channel %1:] Block %2: If tool angle equals 90°, both tool diameters must be equal

Parameters: %1 = Channel number %2 = Block number, label

Explanation: For tool angles equal to 90°, the two tool diameters must be identical. Alarm triggered by following cycle: CYCLE61.

Remedy: Correct the tool angle or the tool diameters.

61280 [Channel %1:] Block %2: %4- Mirroring missing in work offset for counterspindle

Parameters: %1 = Channel number %2 = Block number, label

Explanation: The work offset for counterspindle machining does not have Z mirroring. The alarm is triggered by the following cycle: F_SUB_SP, CYCLE209

Remedy: Select Z mirroring for the work offset used.

61281 [Channel %1:] Block %2: starting point of machining outside retraction planes

Parameters: %1 = Channel number %2 = Block number, label

Explanation: The starting point of machining is outside the retraction planes. Alarm triggered by following cycle: F_SP_RP.

Remedy: Adjust the retraction planes.

61282 [Channel %1:] Block %2: end point of machining outside retraction planes

Parameters: %1 = Channel number %2 = Block number, label

Explanation: The end point of machining is outside the retraction planes. Alarm triggered by following cycle: F_SP_RP.

Remedy: Adjust the retraction planes.

61283 [Channel %1:] Block %2: direct approach not possible, as tool change required

Parameters: %1 = Channel number %2 = Block number, label

Explanation: After block search a position is to be reached by direct approach, but a tool change is required before. Alarm triggered by following cycle: F_TFS.

Remedy: First execute a manual tool change, then restart the block search.

61284 [Channel %1:] Block %2: starting point cannot be approached without collision. Pre-position tool manually

Parameters: %1 = Channel number %2 = Block number, label

Explanation: The starting point cannot be approached without collisions. Alarm triggered by following cycles: F_DRILL, F_DRILLC, F_DRILLD, F_DRM_DR, F_DRM_PE, F_DRM_RE, F_DRM_SI, F_DRM_TA, F_GROOV, F_MIM_TR, F_PARTOF, F_SP_EF, F_TAP, F_TR_CON, F_UCUT_T.

Remedy: Preposition the tool manually.

61285 [Channel %1:] Block %2: parking position is below return plane XRA.

Parameters: %1 = Channel number %2 = Block number, label

Explanation: The parking position is below retraction plane XRA. Alarm triggered by following cycle: F_SP_RP.

Remedy: Move the parking position above retraction plane XRA.

61286 [Channel %1:] Block %2: machining not possible, check tool angle.

Parameters: %1 = Channel number %2 = Block number, label

Explanation: Machining not possible with the specified tool. Alarm triggered by following cycles: F_UCUT_T.

Remedy: Use a suitable tool.

61287 %[[Channel %1:] Block %2: %]no master spindle active.

Parameters: %1 = Channel number %2 = Block number, label

Explanation: No master spindle active. Alarm triggered by following cycle: CYCLE63, CYCLE64, F_TFS.

Remedy: Activate the master spindle (machine data 20090).

61288 [Channel %1:] Block %2: Main spindle not set up

Parameters: %1 = Channel number %2 = Block number, label

Explanation: Alarm triggered by following cycle: CYCLE210

Remedy: Enter channel axis number of main spindle in MD52206 \$MCS_AXIS_USAGE.

61289 [Channel %1:] Block %2: Counterspindle not set up

Parameters: %1 = Channel number %2 = Block number, label

Explanation: Alarm triggered by following cycle: CYCLE210

Remedy: Enter channel axis number of counterspindle in MD52206 \$MCS_AXIS_USAGE.

61290 [Channel %1:] Block %2: Tool spindle not set up**Parameters:** %1 = Channel number

%2 = Block number, label

Explanation: Alarm triggered by following cycle: CYCLE210**Remedy:** Enter channel axis number of tool spindle in MD52206 \$MCS_AXIS_USAGE.**61291 [Channel %1:] Block %2: Linear axis of counterspindle not set up****Parameters:** %1 = Channel number

%2 = Block number, label

Explanation: Alarm triggered by following cycle: CYCLE210**Remedy:** Enter channel axis number of linear axis of counterspindle in MD52206 \$MCS_AXIS_USAGE.**61292 [Channel %1:] Block %2: B axis not set up****Parameters:** %1 = Channel number

%2 = Block number, label

Explanation: Alarm triggered by following cycle: CYCLE210**Remedy:** Enter channel axis number of B axis in MD52206 \$MCS_AXIS_USAGE.**61293 [Channel %1:] Block %2: Tool %4 has no spindle rotation direction****Parameters:** %1 = Channel number

%2 = Block number, label

Explanation: Alarm will be triggered by the following cycles: E_TFS, F_TFS**Remedy:** Select spindle rotation direction in tool list.**61320 [Channel %1:] Block %2: Check tool number****Parameters:** %1 = Channel number %2 = Block number, label**Explanation:** Alarm can be triggered by following measuring cycles: all measuring cycles.**Remedy:** Bei 840D sl:

-Check parameter T. With active tool management, parameter T=0 (_TNUM=0), and parameter _TNAME is empty or the specified tool name is unknown to the tool management.

61328 [Channel %1:] Block %2: Check D number**Parameters:** %1 = Channel number %2 = Block number, label**Explanation:** D number in parameter _KNUM is 0. The alarm can be triggered by all measuring cycles.**Remedy:** Check parameter for tool offset target (_KNUM)**61329 [Channel %1:] Block %2: Check rotary axis****Parameters:** %1 = Channel number

%2 = Block number, label

Explanation: Alarm triggered: CYCLE998**Remedy:** No name assigned to the axis number specified in the parameter of the rotary axis (_RA), or this axis is not configured as a rotary axis. Check MD 20080 and MD 30300.**61343 %[[Channel %1:] Block %2: %]No tool available with this name %4****Parameters:** %1 = Channel number %2 = Block number, label channel number**Explanation:** The alarm can be triggered by the following measuring cycles: all measuring cycles, CYCLE63, CYCLE64**Remedy:** Check tool name.**61357 %[[Channel %1:] Block %2: %]No resources free****Parameters:** %1 = Channel number %2 = Block number, label channel number**Explanation:** Alarm is triggered by the following cycles: CYCLE63, CYCLE64, CYCLE106 Not enough NC memory space available or too many files / directories in the NC file system.**Remedy:** Delete or unload files MD18270: \$MN_MM_NUM_SUBDIR_PER_DIR, MD18280: \$MN_MM_NUM_FILES_PER_DIR or MD18320: Check \$MN_MM_NUM_FILES_IN_FILESYSTEM and increase if necessary.**61403 [Channel %1:] Block %2: Work offset correction not executed****Parameters:** %1 = Channel number

%2 = Block number, label channel number

Explanation: Alarm can be triggered by following measuring cycles: all measuring cycles.**Remedy:** Call the SIEMENS hotline**61519 %[[Channel %1:] Block %2: %]Incorrect type of machining****Parameters:** %1 = Channel number %2 = Block number, label channel number**Explanation:** The alarm can be triggered by the following grinding cycles: CYCLE63, CYCLE64, CYCLE410, CYCLE411, CYCLE412, CYCLE413, CYCLE415, CYCLE952

Remedy: Assign a value between 1 and 3 to parameter B_ART

61532 [Channel %1:] Block %2: Value for _LAGE is incorrect

Parameters: %1 = Channel number
%2 = Block number, label channel number
Explanation: The alarm can be triggered by the following grinding cycle: CYCLE414
Remedy: Correct parameter content for _LAGE

61564 %[[Channel %1:] Block %2: %]Feed insertion <=0

Parameters: %1 = Channel number
%2 = Block number, label channel number
Explanation: The alarm can be triggered by the following grinding cycles: CYCLE434, CYCLE444
Remedy: Check values in grinding wheel data

61601 [Channel %1:] Block %2: Finished part diameter too small

Parameters: %1 = Channel number %2 = Block number, label
Explanation: The programmed radius of the machined part is too small. Alarm triggered by following cycles: CYCLE94, CYCLE96.
Remedy: Check parameter SPD or DIATH.

61602 [Channel %1:] Block %2: Tool width incorrectly defined

Parameters: %1 = Channel number %2 = Block number, label
Explanation: Plunge cutter is larger than the programmed groove width. Alarm triggered by following cycle: CYCLE93.
Remedy: Check tool or change program.

61603 [Channel %1:] Block %2: Recess type incorrectly defined

Parameters: %1 = Channel number %2 = Block number, label
Explanation: Radii/chamfers at the groove base do not match the groove width. Face groove on a contour element running parallel to the longitudinal axis is not possible. Alarm triggered by following cycle: CYCLE93.
Remedy: Check parameter VARI.
Clear alarm with the RESET key. Restart part program

61604 [Channel %1:] Block %2: Active tool violates programmed contour

Parameters: %1 = Channel number %2 = Block

number, label

Explanation: Contour violation in the relief cut elements due to the tool clearance angle of the tool used. Alarm triggered by following cycle: CYCLE95.

Remedy: Use a different tool or check the contour subroutine.

61605 [Channel %1:] Block %2: Contour incorrectly programmed

Parameters: %1 = Channel number %2 = Block number, label
Explanation: Illegal relief cut element detected. Alarm triggered by following cycles: CYCLE76, CYCLE77, CYCLE95.
Remedy: Check contour program.

61606 [Channel %1:] Block %2: Error during contour preparation

Parameters: %1 = Channel number %2 = Block number, label
Explanation: An error has been found on conditioning the contour. This alarm is always related to one of NCK alarms 10930...10934, 15800 or 15810. Alarm triggered by following cycle: CYCLE95.
Remedy: Check contour subroutine.

61607 [Channel %1:] Block %2: Starting point incorrectly programmed

Parameters: %1 = Channel number %2 = Block number, label
Explanation: The starting point reached before the cycle call does not lie outside the rectangle described by the contour subroutine. Alarm triggered by following cycle: CYCLE95.
Remedy: Check starting point prior to cycle call.

61608 [Channel %1:] Block %2: Incorrect tool point direction programmed

Parameters: %1 = Channel number %2 = Block number, label
Explanation: Alarm triggered by following cycles: CYCLE94, CYCLE96.
Remedy: A cutting edge position 1...4, matching the undercut form, must be programmed.

61609 [Channel %1:] Block %2: Shape incorrectly defined

Parameters: %1 = Channel number %2 = Block number, label
Explanation: Alarm triggered by following cycles: CYCLE94, CYCLE96, LONGHOLE, POCKET3, SLOT1.
Remedy: Check parameter for the undercut form or groove form or pocket.

61610 [Channel %1:] Block %2: No infeed depth programmed

Parameters: %1 = Channel number
%2 = Block number, label

Explanation: Alarm triggered by following cycles: CYCLE76, CYCLE77, CYCLE96.

Remedy: Check parameter MID.

61611 [Channel %1:] Block %2: No point of intersection found

Parameters: %1 = Channel number
%2 = Block number, label

Explanation: No intersection could be calculated with the contour. Alarm triggered by following cycle: CYCLE95.

Remedy: Check contour programming or modify infeed depth.

61612 [Channel %1:] Block %2: Thread finishing not possible

Parameters: %1 = Channel number
%2 = Block number, label

Explanation: Alarm triggered by following cycles: CYCLE97, CYCLE98.

Remedy: Check the conditions for thread finishing.

61613 [Channel %1:] Block %2: Undercut position incorrectly defined

Parameters: %1 = Channel number
%2 = Block number, label

Explanation: Alarm triggered by following cycles: CYCLE94, CYCLE96.

Remedy: Check value in parameter _VARI.

61700 %[[Channel %1:] Block %2: %]Name of program to be generated is missing

Parameters: %1 = Channel number
%2 = Block number, label

Explanation: Alarm triggered by following cycle: CYCLE952

Remedy: - Check parameter PRG

61701 %[[Channel %1:] Block %2: %]Contour %4 does not exist

Parameters: %1 = Channel number
%2 = Block number, label

Explanation: Alarm triggered by following cycle: CYCLE952

Remedy: - Check parameter CON
- Check contour call
- Check whether the contours exist in the program storage (workpieces, subroutines or part programs)

61702 %[[Channel %1:] Block %2: %]Label %4 not existing in machined part contour

Parameters: %1 = Channel number
%2 = Block number, label

Explanation: Alarm triggered by following cycle: CYCLE952

Remedy: - Check whether the labels exist in the machined part contour

61703 %[[Channel %1:] Block %2: %]Label %4 not existing in the blank contour

Parameters: %1 = Channel number
%2 = Block number, label

Explanation: Alarm triggered by following cycle: CYCLE952

Remedy: - Check whether the labels exist in the blank contour

61704 %[[Channel %1:] Block %2: %]Machined part contour missing

Parameters: %1 = Channel number %2 = Block number, label

Explanation: Alarm triggered by following cycle: CYCLE952

Remedy: - Check contour call

61705 %[[Channel %1:] Block %2: %]Blank contour missing

Parameters: %1 = Channel number
%2 = Block number, label

Explanation: Alarm triggered by following cycle: CYCLE952

Remedy: - Check contour call

61706 %[[Channel %1:] Block %2: %]Error in machined part contour %4

Parameters: %1 = Channel number
%2 = Block number, label

Explanation: Alarm triggered by following cycle: CYCLE952

Remedy: - Check programming of machined part contour

61707 %[[Channel %1:] Block %2: %]Error in the blank contour %4

Parameters: %1 = Channel number
%2 = Block number, label

Explanation: Alarm triggered by following cycle: CYCLE952

Remedy: - Check programming of the blank contour

61708 %[[Channel %1:] Block %2: %]Too many contours specified

Parameters: %1 = Channel number
%2 = Block number, label

Explanation: Alarm triggered by following cycle: CYCLE952

Remedy: - Check number of contours
- Max. two contours (machined part and blank contours)
- Min. one contour (machined part contour)

61709 %[[Channel %1:] Block %2: %]Cutting edge radius too small

Parameters: %1 = Channel number
%2 = Block number, label

Explanation: Alarm triggered by following cycle: CYCLE952.

Remedy: - Check cutting edge radius of the tool in tool management

61710 %[[Channel %1:] Block %2: %]Calculation has been cancelled

Parameters: %1 = Channel number
%2 = Block number, label

Explanation: Alarm triggered by following cycle: CYCLE952.

Remedy: - Calculation has been cancelled by PI service; please try again

61711 %[[Channel %1:] Block %2: %]Infeed D is larger than the tip width of the tool

Parameters: %1 = Channel number
%2 = Block number, label

Explanation: Alarm triggered by following cycle: CYCLE952.

Remedy: - Check infeed D in connection with the tip width of the tool in tool management.

61712 %[[Channel %1:] Block %2: %]Infeed DX or DZ is larger than tip length of tool

Parameters: %1 = Channel number
%2 = Block number, label

Explanation: Alarm triggered by following cycle: CYCLE952.

Remedy: - Check infeed DX or DZ in connection with tip length of the tool in tool management.

61713 %[[Channel %1:] Block %2: %]Tool radius larger than half the tip width

Parameters: %1 = Channel number
%2 = Block number, label

Explanation: Alarm triggered by following cycle: CYCLE952.

Remedy: - Check tool radius and tip width of tool (plunge cutter, cutting tool)

61714 %[[Channel %1:] Block %2: %]System error contour turning %4

Parameters: %1 = Channel number %2 = Block number, label

Explanation: Alarm triggered by following cycle: CYCLE952.

Remedy: With error number 103 the cycle is parameterized incorrectly. Change the program name in the cycle. PRG parameters: the name of the part program must not already exist in the calling directory or used a second time.

61730 %[[Channel %1:] Block %2: %]Machining range outside delimitation

Parameters: %1 = Channel number
%2 = Block number, label

Explanation: Alarm triggered by following cycle: CYCLE952

Remedy: - Check machining range and delimitation

61731 %[[Channel %1:] Block %2: %]Unable to determine contour direction

Parameters: %1 = Channel number
%2 = Block number, label

Explanation: Alarm triggered by following cycle: CYCLE952

Remedy: - Check contours
- Check whether the contour starting point exists

61732 %[[Channel %1:] Block %2: %]No material available for machining

Parameters: %1 = Channel number
%2 = Block number, label

Explanation: Alarm triggered by following cycle: CYCLE952

Remedy: - Check programming of the blank and machined part contour, particularly their position towards each other

61733 %[[Channel %1:] Block %2: %]Cutting edge not compatible with cutting direction

Parameters: %1 = Channel number %2 = Block number, label

Explanation: Alarm triggered by following cycle: CYCLE952

Remedy: - Check cutting edge position and cutting direction in tool management

61734 %[[Channel %1:] Block %2: %]Machined part contour is outside the blank contour

Parameters: %1 = Channel number
%2 = Block number, label

Explanation: Alarm triggered by following cycle: CYCLE952

Remedy: - Check programming of the machined part and blank contour, particularly their position towards each other.

61735 %[[Channel %1:] Block %2: %]Infeed D larger than the tip length of the tool

Parameters: %1 = Channel number
%2 = Block number, label

Explanation: Alarm triggered by following cycle: CYCLE952

Remedy: - Check infeed D in relation to the tip length of the tool in tool management

61736 %[[Channel %1:] Block %2: %]Cutting depth greater than maximum depth of cut of the tool

Parameters: %1 = Channel number
%2 = Block number, label

Explanation: Alarm triggered by following cycle: CYCLE952

Remedy: - Clear alarm with the RESET key. Restart part program.

61737 %[[Channel %1:] Block %2: %]Cutting depth smaller than minimum depth of cut of the tool

Parameters: %1 = Channel number
%2 = Block number, label

Explanation: Alarm triggered by following cycle: CYCLE952

Remedy: - Clear alarm with the RESET key. Restart part program.

61738 %[[Channel %1:] Block %2: %]Incorrect cutting edge position

Parameters: %1 = Channel number
%2 = Block number, label

Explanation: Alarm triggered by following cycle: CYCLE952

Remedy: - Check cutting edge position in tool management

61739 %[[Channel %1:] Block %2: %]Blank must be closed contour

Parameters: %1 = Channel number
%2 = Block number, label

Explanation: Alarm triggered by following cycle: CYCLE952

Remedy: - Check whether the blank contour is closed

61740 %[[Channel %1:] Block %2: %]Collision through approach

Parameters: %1 = Channel number
%2 = Block number, label

Explanation: Alarm triggered by following cycle: CYCLE952

Remedy: - Select the starting position to enable collision-free approach of the contour

61741 %[[Channel %1:] Block %2: %]Axis in negative range

Parameters: %1 = Channel number
%2 = Block number, label

Explanation: Alarm triggered by following cycle: CYCLE952

Remedy: - Check the position of the axis in the ordinate

61742 %[[Channel %1:] Block %2: %]Retraction plane %4 is within the machining range

Parameters: %1 = Channel number
%2 = Block number, label

Explanation: Alarm triggered by following cycle: CYCLE952

Remedy: - On internal machining check machining range in relation to the entered retraction distance (\$SCS_TURN_ROUGH_I_RELEASE_DIST)

61800 [Channel %1:] Block %2: Ext. CNC system missing

Parameters: %1 = Channel number
%2 = Block number, label

Explanation: Machine data for external language MD18800: \$MN_MM_EXTERN_LANGUAGE or option bit 19800 \$ON_EXTERN_LANGUAGE is not set.

Remedy: Clear alarm with the RESET key. Restart part program.

61801 [Channel %1:] Block %2: Wrong G code selected

Parameters: %1 = Channel number
%2 = Block number, label

Explanation: In the program call CYCLE300<value> an impermissible numerical value was programmed for the entered CNC System, or in the Cycles Setting Datum an incorrect value for the G Code System was set.

Remedy: - Clear alarm with the RESET key. Restart part program

61803 [Channel %1:] Block %2: Programmed axis not available

Parameters: %1 = Channel number
%2 = Block number, label

Explanation: The programmed axis is not in

the system. Alarm triggered by following cycles: CYCLE83, CYCLE84, CYCLE840.

Remedy: Check parameter _AXN. Check MD20050-20080.

61807 [Channel %1:] Block %2: Wrong spindle direction programmed (active)

Parameters: %1 = Channel number %2 = Block number, label

Explanation: Alarm triggered by following cycle: CYCLE840. The programmed spindle direction contradicts the spindle direction planned for the cycle.

Remedy: Check parameters SDR and SDAC.

61809 [Channel %1:] Block %2: Drill position not permissible

Parameters: %1 = Channel number %2 = Block number, label

61816 [Channel %1:] Block %2: Axes not on reference point

Parameters: %1 = Channel number %2 = Block number, label

61900 %[[Channel %1:] Block %2: %]Name of program to be generated is missing

Parameters: %1 = Channel number %2 = Block number, label

Explanation: Alarm triggered by following cycles: CYCLE63, CYCLE64

Remedy: - Check parameter PRG

61901 %[[Channel %1:] Block %2: %]Contour %4 does not exist

Parameters: %1 = Channel number %2 = Block number, label

Explanation: Alarm triggered by following cycles: CYCLE63, CYCLE64

Remedy: - Check contour call
- Check whether the contours exist in the program storage (workpieces, subroutines or part programs)

61902 %[[Channel %1:] Block %2: %]Label %4 not existing in the pocket contour

Parameters: %1 = Channel number %2 = Block number, label

Explanation: Alarm triggered by following cycles: CYCLE63

Remedy: - Check whether the labels exist in the pocket contour

61903 %[[Channel %1:] Block %2: %]Label %4 not existing in the blank contour

Parameters: %1 = Channel number %2 = Block number, label

Explanation: Alarm triggered by following cycles: CYCLE63

Remedy: - Check whether the labels exist in the blank contour

61904 %[[Channel %1:] Block %2: %]Label %4 not existing in the island contour

Parameters: %1 = Channel number %2 = Block number, label

Explanation: Alarm triggered by following cycles: CYCLE63

Remedy: - Check whether the labels exist in the island contour

61905 %[[Channel %1:] Block %2: %]Label %4 not existing in the spigot contour

Parameters: %1 = Channel number %2 = Block number, label

Explanation: Alarm triggered by following cycles: CYCLE63

Remedy: - Check whether the labels exist in the spigot contour

61906 %[[Channel %1:] Block %2: %]Label %4 not existing in the contour

Parameters: %1 = Channel number %2 = Block number, label

Explanation: Alarm triggered by following cycles: CYCLE64

Remedy: - Check whether the labels exist in the contour

61907 %[[Channel %1:] Block %2: %]Pocket contour missing

Parameters: %1 = Channel number %2 = Block number, label

Explanation: Alarm triggered by following cycles: CYCLE63, CYCLE64

Remedy: - Check contour call

61908 %[[Channel %1:] Block %2: %]Blank contour missing

Parameters: %1 = Channel number %2 = Block number, label

Explanation: Alarm triggered by following cycles: CYCLE63, CYCLE64

Remedy: - Check contour call

61909 %[[Channel %1:] Block %2: %]Error in pocket contour %4

Parameters: %1 = Channel number %2 = Block number, label

Explanation: Alarm triggered by following cycles: CYCLE63

Remedy: - Check programming of the pocket contour

61910 %[[Channel %1:] Block %2: %]Error in the blank contour %4

Parameters: %1 = Channel number

%2 = Block number, label

Explanation: Alarm triggered by following cycles: CYCLE63

Remedy: - Check programming of the blank contour

61911 %[[Channel %1:] Block %2: %]Error in island contour %4

Parameters: %1 = Channel number

%2 = Block number, label

Explanation: Alarm triggered by following cycles: CYCLE63

Remedy: - Check programming of the island contour

61912 %[[Channel %1:] Block %2: %]Error in spigot contour %4

Parameters: %1 = Channel number

%2 = Block number, label

Explanation: Alarm triggered by following cycles: CYCLE63

Remedy: - Check programming of the spigot contour

61913 %[[Channel %1:] Block %2: %]Error in contour %4

Parameters: %1 = Channel number

%2 = Block number, label

Explanation: Alarm triggered by following cycles: CYCLE64

Remedy: - Check programming of the contour

61914 %[[Channel %1:] Block %2: %]Too many contours specified

Parameters: %1 = Channel number

%2 = Block number, label

Explanation: Alarm triggered by following cycles: CYCLE63, CYCLE64

Remedy: - Check the number of contours

61915 %[[Channel %1:] Block %2: %]Cutter radius too small

Parameters: %1 = Channel number

%2 = Block number, label

Explanation: Alarm triggered by following cycles: CYCLE63, CYCLE64

Remedy: - Check the radius of the milling cutter in tool management

61916 %[[Channel %1:] Block %2: %]Calculation has been cancelled

Parameters: %1 = Channel number

%2 = Block number, label

Explanation: Alarm triggered by following cycles: CYCLE63, CYCLE64

Remedy: - Calculation has been cancelled by PI service; please try again

61917 %[[Channel %1:] Block %2: %]Combination of centering/predrilling and spigot not allowed

Parameters: %1 = Channel number

%2 = Block number, label

Explanation: Alarm triggered by following cycles: CYCLE63

Remedy: - Machining of spigot in conjunction with predrilling/centering not allowed!

61918 %[[Channel %1:] Block %2: %]Cut. radius for residual mach. must be smaller than cut. radius for ref. tool

Parameters: %1 = Channel number

%2 = Block number, label

Explanation: Alarm triggered by following cycles: CYCLE63

Remedy: - Check cutter radius for residual machining which must be smaller than cutter radius for reference tool !

61919 %[[Channel %1:] block %2: %]Radius of the reference tool is too small

Parameters: %1 = Channel number

%2 = Block number, label

Explanation: Alarm triggered by following cycles: CYCLE63, CYCLE64

Remedy: - Check the radius of the reference tool.

61920 %[[Channel %1:] block %2: %]System error contour milling %4

Parameters: %1 = Channel number

%2 = Block number, label

Explanation: Alarm triggered by following cycles: CYCLE63, CYCLE64

Remedy: With error number 103 the cycle is parameterized incorrectly. Change the program name in the cycle. PRG parameters: the name of the part program must not already exist in the calling directory or used a second time.

61930 %[[Channel %1:] Block %2: %]No contour available

Parameters: %1 = Channel number

%2 = Block number, label

Explanation: Alarm triggered by following cycles:
CYCLE63, CYCLE64

Remedy: - Check contour call
- Check whether the contours exist in the program storage (workpieces, subroutines or part programs)

61931 %[[Channel %1:] Block %2: %]Contour not closed

Parameters: %1 = Channel number
%2 = Block number, label

Explanation: Alarm triggered by following cycles:
CYCLE63, CYCLE64

Remedy: - Check whether the contours are closed

61932 %[[Channel %1:] Block %2: %]Selfcutting contour

Parameters: %1 = Channel number %2 = Block number, label

Explanation: Alarm triggered by following cycles:
CYCLE63, CYCLE64

Remedy: - Modify contour programming

61933 %[[Channel %1:] Block %2: %]Too many contour elements

Parameters: %1 = Channel number
%2 = Block number, label

Explanation: Alarm triggered by following cycles:
CYCLE63, CYCLE64

Remedy: - Modify contour programming and thereby try to reduce the number of contour elements

61934 %[[Channel %1:] Block %2: %]Programming of the machining plane not allowed here

Parameters: %1 = Channel number
%2 = Block number, label

Explanation: Alarm triggered by following cycles:
CYCLE63, CYCLE64

Remedy: - Modify contour programming

61935 %[[Channel %1:] Block %2: %]Programming of inch/metric measuring system not allowed here

Parameters: %1 = Channel number
%2 = Block number, label

Explanation: Alarm triggered by following cycles:
CYCLE63, CYCLE64

Remedy: - Modify contour programming

61936 %[[Channel %1:] Block %2: %]G0 is not allowed in contour programming

Parameters: %1 = Channel number
%2 = Block number, label

Explanation: Alarm triggered by following cycles:
CYCLE63, CYCLE64

Remedy: - Modify contour programming, replace G0 by G1

61937 %[[Channel %1:] Block %2: %]Pocket depth programmed incorrectly

Parameters: %1 = Channel number
%2 = Block number, label

Explanation: Alarm triggered by following cycles:
CYCLE63

Remedy: - Check parameter Z1

61938 %[[Channel %1:] Block %2: %]No starting point specified

Parameters: %1 = Channel number
%2 = Block number, label

Explanation: Alarm triggered by following cycles:
CYCLE63

Remedy: - Check parameter for specified starting point,
- for G17: XS, YS
- for G18: ZS, XS
- for G19: YS, ZS

61939 %[[Channel %1:] Block %2: %]No center point specified for circle

Parameters: %1 = Channel number
%2 = Block number, label

Explanation: Alarm triggered by following cycles:
CYCLE63, CYCLE64

Remedy: - Check contour programming, particularly circular-path programming

61940 %[[Channel %1:] Block %2: %]Specified starting point programmed incorrectly

Parameters: %1 = Channel number
%2 = Block number, label

Explanation: Alarm triggered by following cycles:
CYCLE63

Remedy: - Correct specified starting point

61941 %[[Channel %1:] Block %2: %]Helix radius too small

Parameters: %1 = Channel number %2 = Block number, label

Explanation: Alarm triggered by following cycles:
CYCLE63

Remedy: - Increase helix radius

61942 %[[Channel %1:] Block %2: %]Helix violates contour

Parameters: %1 = Channel number
%2 = Block number, label

Explanation: Alarm triggered by following cycles:
CYCLE63

Remedy: - Check helix radius and reduce in size, if possible

61943 %[[Channel %1:] Block %2: %]Approach/retract motion violates contour

Parameters: %1 = Channel number

%2 = Block number, label

Explanation: Alarm triggered by following cycles: CYCLE63, CYCLE64

Remedy: - Reduce safety clearance SC, if possible

61944 %[[Channel %1:] Block %2: %]Ramp path too short

Parameters: %1 = Channel number

%2 = Block number, label

Explanation: Alarm triggered by following cycles: CYCLE63

Remedy: - Check insertion angle, possibly use different insertion mode

- Use tool with smaller radius

61945 %[[Channel %1:] Block %2: %]Plane infeed too large, residual corners remaining

Parameters: %1 = Channel number

%2 = Block number, label

Explanation: Alarm triggered by following cycles: CYCLE63

Remedy: - Check parameter for plane infeed

- for G17: DXY

- for G18: DZX

- for G19: DYZ

61946 %[[Channel %1:] Block %2: %]Island contour existing twice

Parameters: %1 = Channel number

%2 = Block number, label

Explanation: Alarm triggered by following cycles: CYCLE63, CYCLE64

Remedy: - Delete double island contour

61947 %[[Channel %1:] Block %2: %]Spigot contour existing twice

Parameters: %1 = Channel number

%2 = Block number, label

Explanation: Alarm triggered by following cycles: CYCLE63, CYCLE64

Remedy: - Delete double spigot contour

61948 %[[Channel %1:] Block %2: %]No material available for machining

Parameters: %1 = Channel number

%2 = Block number, label

Explanation: Alarm triggered by following cycles: CYCLE63, CYCLE64

Remedy: - Check programming of the contours

61949 %[[Channel %1:] Block %2: %]Island is outside the pocket

Parameters: %1 = Channel number

%2 = Block number, label

Explanation: Alarm triggered by following cycles: CYCLE63, CYCLE64

Remedy: - Check programming of the island/pocket contour

61950 %[[Channel %1:] Block %2: %]No residual material available

Parameters: %1 = Channel number

%2 = Block number, label

Explanation: Alarm triggered by following cycles: CYCLE63

61951 %[[Channel %1:] Block %2: %]Cutter radius for residual material too large

Parameters: %1 = Channel number

%2 = Block number, label

Explanation: Alarm triggered by following cycles: CYCLE63

Remedy: - Use cutter with smaller radius

61952 %[[Channel %1:] Block %2: %]Radius of res. material cutter too small in relation to ref. cutter

Parameters: %1 = Channel number

%2 = Block number, label

Explanation: Alarm triggered by following cycles: CYCLE63

Remedy: - Use a cutter with a larger radius for residual machining

62100 [Channel %1:] Block %2: No drilling cycle active

Parameters: %1 = Channel number %2 = Block number, label

Explanation: No modal drilling cycle has been called before the drilling pattern cycle call. Alarm triggered by following cycles: HOLES1, HOLES2.

Remedy: Check whether a drilling cycle was called prior to calling the drilling pattern cycle.

62101 [Channel %1:] Block %2: Milling direction incorrect - G3 is generated

Parameters: %1 = Channel number

%2 = Block number, label

Explanation: Synchronous or reverse rotation programmed. But the spindle does not rotate at a cycle call.

Remedy: Check value in parameter CDIR.

62103 [Channel %1:] Block %2: No finishing allowance programmed

Parameters: %1 = Channel number
%2 = Block number, label

Explanation: No finishing allowance is programmed, although it is necessary for this machining.

Remedy: Program a finishing allowance.

62106 [Channel %1:] Block %2: incorrect value for monitoring status in tool monitoring

Parameters: %1 = Channel number %2 = Block number, label

62180 [Channel %1:] Block %2: Set rotary axes %4 [deg]

Parameters: %1 = Channel number %2 = Block number, label

Explanation: Alarm triggered by following cycle: CYCLE800. Note on 62180 and 62181: Sample display of the swivel angle to be set for a manual rotary axis in CYCLE800: 62181 "Set rotary axis B: 32.5 [grd]"

Remedy: Settable angles for manual rotary axes.

62181 [Channel %1:] Block %2: Set rotary axis %4 [deg]

Parameters: %1 = Channel number %2 = Block number, label

Explanation: Alarm triggered by following cycle: CYCLE800. Note on 62180 and 62181: Sample display of the swivel angle to be set for a manual rotary axis in CYCLE800: 62181 "Set rotary axis B: 32.5 [grd]"

Remedy: Settable angle for manual rotary axis.

62182 [Channel %1:] Block %2 : load inclinable head: %4

Parameters: %1 = Channel number
%2 = Block number, label

Explanation: No swivel head is active. Alarm triggered by following cycles: E_TCARR, F_TCARR.

Remedy: Request to load a swivel head.

62183 [Channel %1:] Block %2 : unload inclinable head: %4

Parameters: %1 = Channel number
%2 = Block number, label

Explanation: Alarm triggered by following cycle: CYCLE800.

62184 [Channel %1:] Block %2 : replace inclinable head: %4

Parameters: %1 = Channel number
%2 = Block number, label

Explanation: Alarm triggered by following cycle: CYCLE800.

62185 [Channel %1:] Block %2 : angle adapted to angle grid: %4

Parameters: %1 = Channel number %2 = Block number, label

Explanation: %4 difference angle with Hirth tooth system Alarm triggered by following cycle: CYCLE800.

Remedy: Check setup of swivel CYCLE800.

62186 [Channel %1:] Block %2: No swiveling in JOG -> WO G%4 active and total basic WO (G500) contain rotations

Parameters: %1 = Channel number %2 = Block number, label

Explanation: Alarm triggered by following cycle: CYCLE800. On swiveling in JOG no rotation can be written to the work offset WO, if rotations are already contained in the total basic WO or in the basic reference Error 62186 message can be masked -> see setting data 55410 \$SCS_MILL_SWIVEL_ALARM_MASK

Remedy: ...%4 number of the active work offset WO.

62187 [Channel %1:] Block %2: Swiveling in JOG --> G500 active and total basic WO or basic reference contain rotations

Parameters: %1 = Channel number %2 = Block number, label

Explanation: Alarm triggered by following cycle: CYCLE800. During swiveling in JOG, it is not possible to write a rotation into the work offset WO, if, with active G500, rotations are already contained in the total basic WO or in the basic reference Error message 62187 can be masked -> see setting data 55410 \$SCS_MILL_SWIVEL_ALARM_MASK

Remedy: See notes for 62186 and 62187.

62201 [Channel %1:] Block %2: Z offset does not influence the retraction planes.

Parameters: %1 = Channel number %2 = Block number, label

Explanation: The retraction planes refer to the workpiece. Therefore, programmable offsets do not influence the retraction planes. Alarm triggered by following cycle: F_SP_RP.

Remedy: Ensure that the offset will not cause a collision. Then start the NC. The alarm can be suppressed via display machine data 9898.

**62202 [Channel %1:] Block %2: NOTICE:
tool travels directly to machining!**

Parameters: %1 = Channel number %2 = Block number, label

Explanation: After block search a position is to be reached by direct approach. Alarm triggered by following cycle: F_TFS.

Remedy: Check whether the desired position can be reached without collision. Then execute an NC start.

W: Accessory Functions

Activating accessory functions

According to the machine (turn/mill) the following accessories can be taken into operation:

- automatic tailstock
- automatic vice/clamping device
- Air purge system
- Dividing attachment
- Robot interface
- Automatic doors
- Win3D view simulation software
- DNC interface

The accessories are activated with EMConfig.

Robotic Interface

The robotic interface is used to connect the concept machines to an FMS/CIM system.

The most important functions of a concept machine can be automated via the inputs and outputs of an optional hardware module.

The following functions can be controlled via the robotic interface:

- Program START / STOP
- Door open / closed
- Quill clamp / back
- Clamping device open / closed
- Feed STOP

Note:

The functionality of the Win3D-View is depending on the control software that is used.



Automatic doors

Preconditions for activation:

- The auxiliary drives must be switched on.
- The main spindle must be still (M05 or M00) - this also means that the run-out phase of the main spindle must be ended (program dwell time if required).
- The feed axes must be still.
- The tool changer must be still.

Behavior when automatic doors active:

Opening door

The door can be opened manually, via the robot interface or DNC interface.

In addition, the door opens when the following commands are executed in the CNC program:

- M00
- M01
- M02
- M30

Closing door:

The door can be closed by manually pressing the button via the robot interface. It is not possible to close the door via the DNC interface.

Win3D View

Win3D View is a 3D simulation for turning and milling, which is offered as an additional option for the WinNC product. Graphical simulations of CNC controls are primarily designed for industrial practice. The Win3D View screen representation goes beyond the industrial standard. Tools, raw parts, clamping devices and the processing steps are represented extremely realistically. The programmed movement paths of the tool are checked by the system for a collision with clamping device and raw part. A warning message is issued when there is danger. This makes possible to have understanding and control of the manufacturing process already on the screen.

Win3D View is used to visualize and prevent costly collisions.

Win3D View offers the following advantages:

- Extremely realistic representation of workpiece
- Tool and clamping device collision control
- Cut representation
- Zoom functions and turning of views
- Representation as solid or wireframe model

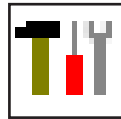

Tool modelling with the 3D-Tool Generator

With the 3D-ToolGenerator you can modify existing tools and create new tools.

- 1 Register cards for "Geometry", "General" and "Machines" for drilling and milling tools and "Tip", "Holder", "General" and "Machines" for turning tools.
- 2 Selection of tool types
- 3 This window enables the input of tool dimensions.
- 4 Graphical support for the tool dimensioning
- 5 Choice of tools for the selected tool type
- 6 Choice of tool types (here: only drill) "Turning tool", "Milling tool" and "Drilling tool" reduce the tool choice to the respective type (here: only drilling tools are listed). "All" does not reduce the tool choice.
- 7 Buttons for quickly browsing through the tools
 - << go to first tool in the group
 - >> go to last tool in the group
 - < go forward in the list by one tool
 - > go back in the list by one tool
- 8 Button to delete tools
- 9 Button to create new tools
- 10 Button to copy tools
- 11 Button to save changes
- 12 Button for 3D visualization
- 13 Button to sort tools
- 14 Button to terminate the 3DView tool generator



Enable edit

Editing is activated with this button (15). In order to make changes in the 3D ToolGenerator, the password "emco" must be entered. This activates the Delete (8), New (9) and Copy (10) functions.



Generating a new tool

- Set the selection for tool types to "Selection all".
- Press the button to generate new tools.
- Select the tool name (1), the tool type (2) and the measurement system (3).

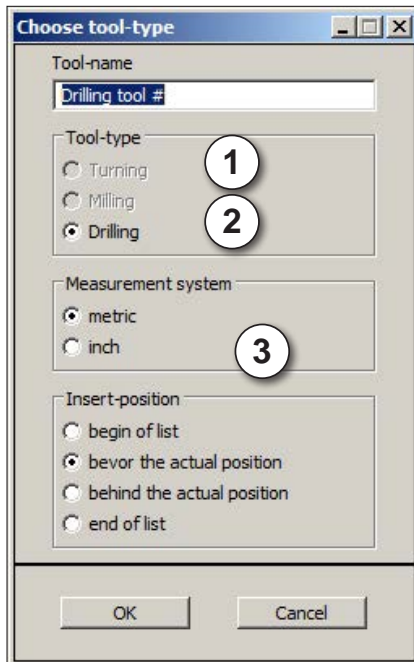

- Confirm the entries with "OK".

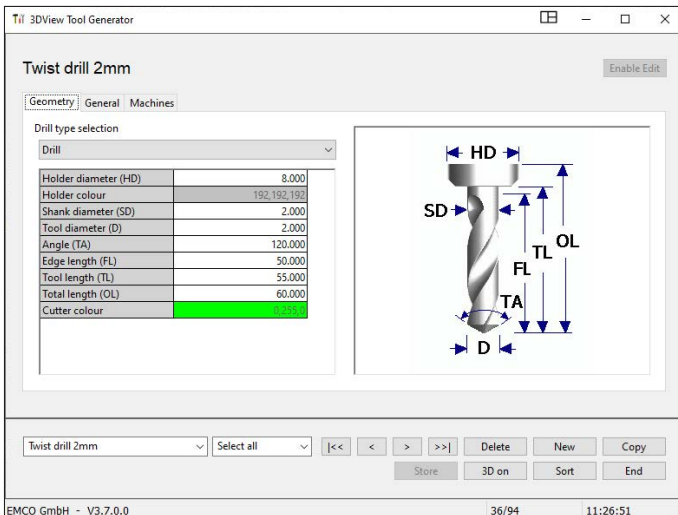

- Define all tool dimensions.
- Define all tool colours (see "select tool colour").

Copying a tool



- Call the tool you wish to copy.
- Press the button to copy tools.
- Enter the new tool name.
- Confirm the inputs with "Save".



- Confirm the entries with "Store".

Changing an existing tool



- Call the tool you wish to change.
- Change the values.
- Confirm the entries with "Store".

Selecting a tool colour

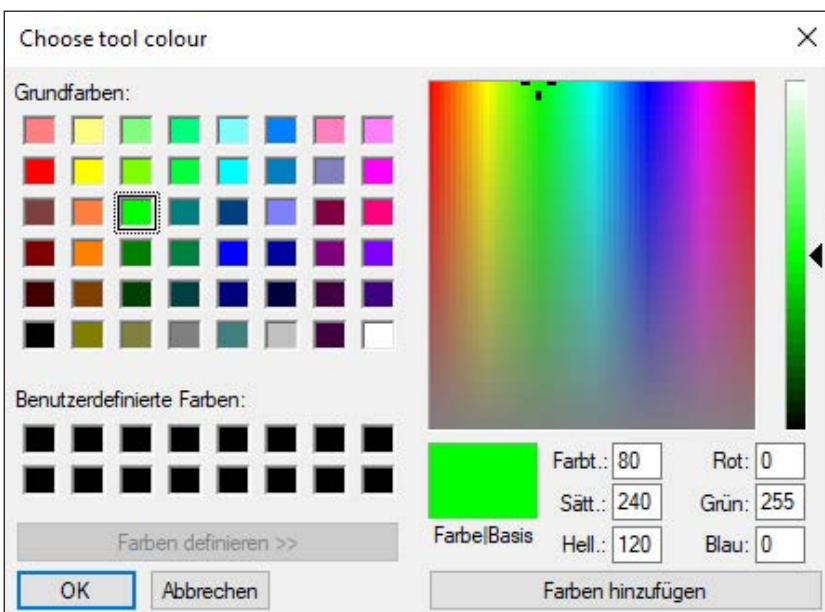

- Make a double click with the mouse pointer in the coloured box of the tool colour. The window "Select tool colour" will appear.
- Select the required colour.



- Confirm the entries with "OK".

Visualizing a tool

- Press the button for 3D visualization.

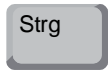
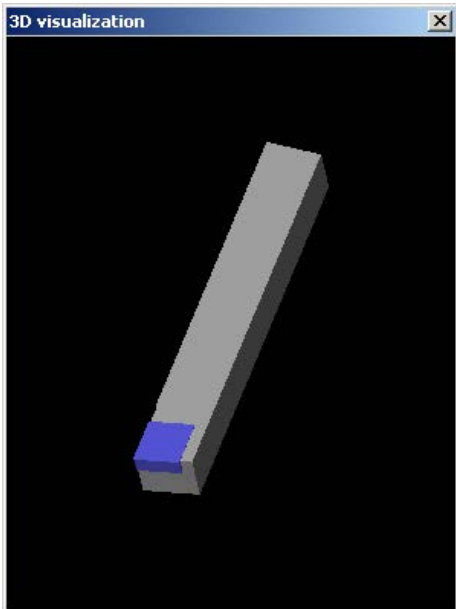

Rotating image

At any time you can rotate the simulation image in one plane as required by pressing and holding the left mouse button. For movements around the Z axis press "Shift" + left mouse button + mouse movement to the right or to the left.

Zooming

You can zoom the tool simulation image in or out by means of „Ctrl“ + left mouse button + mouse movement upwards or downwards

Shifting

Press the right mouse button + mouse movement in the required direction to shift the simulation image.

Sorting function

The sorting sequence makes it possible to display the tools being sorted according to tool types. Every time the sorting sequence is changed, the selection for tools will be updated.

- Press the button for sorting.

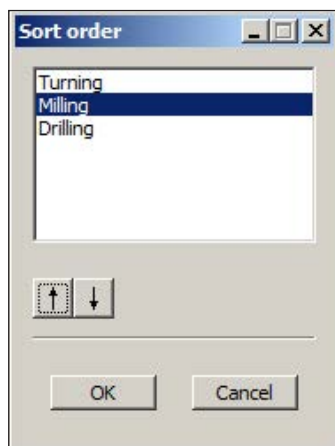

- Define new sorting sequence.

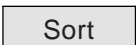

- Confirm the entries with "OK".

DNC interface

The DNC interface (Distributed Numerical Control) enables the control system (WinNC) to be controlled remotely via a software protocol.

The DNC interface is activated with EMConfig, by indicating TCP/IP or a serial interface for the DNC.

During the installation of the control software, the DNC interface is enabled and configured, and can be reconfigured with EMConfig later on.

The DNC interface creates a connection between a higher-level computer (production control computer, FMS computer, DNS host computer, etc.) and the control computer of an NC machine. After activation of the DNC drive the DNC computer (Master) takes over control of the NC machine (Client). The DNC computer takes over complete control of the manufacturing. The automation fittings such as door, chuck (collet), quill, coolant, etc. can be controlled from the DNC computer. The current status of the NC machine is visible on the DNC computer.

The following data can be transferred or loaded via the DNC interface:

- NC Start
- NC Stop
- RESET
- Approach reference point
- Periphery control
- Override data

The DNC interface can be operated with the following CNC control types:

- EMCO WinNC for Sinumerik Operate T and M
- EMCO WinNC for Fanuc31i T and M
- EMCO WinNC for Heidenhain TNC640

Further details of the functions and the DNC protocol can be found in the accompanying product documentation.

If the DNC interface is operated with TCP/IP, it will wait for incoming connections on port 5557.

X: EMConfig

Note:

The settings which are available in EMConfig are depending on the machine and the control that is used.



General

EMConfig is a configuration software for WinNC. EMConfig helps you to alter the settings of WinNC.

The most important settings are:

- Control language
- System of measurement mm - inch
- Activate accessories
- Selection of interface for control keyboard

Using EMConfig you can also activate diagnostic functions in case of troubles - that way you get help immediately.



Safety-related parameters are protected by a password. They can only be activated by set-up technicians or by technical support representatives.

Note:

In order to be able to make changes in EM-Config, the password “emco” must be entered (1).

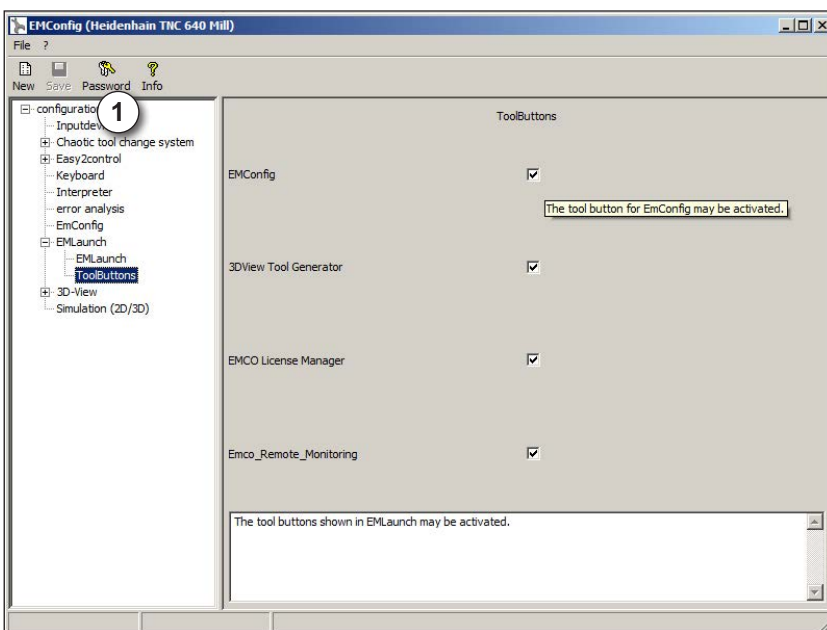

The following ToolButtons for EMLaunch can be activated or deactivated, e.g.:

- EMConfig
- 3DView Tool Generator
- EMCO License Manager
- Emco_Remote_Monitoring

EMLaunch configuration



Icon for EMConfig

How to start EMConfig

Open EMConfig.

In case several control types are installed, a selection box will appear on the screen.

Select the required control type and click OK.

The following settings are only valid for the selected control type.

The window for EMConfig appears on the screen.

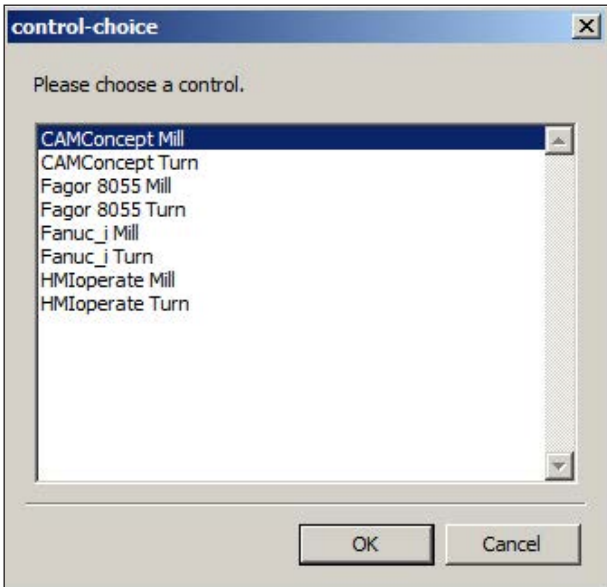

Selection box for control type

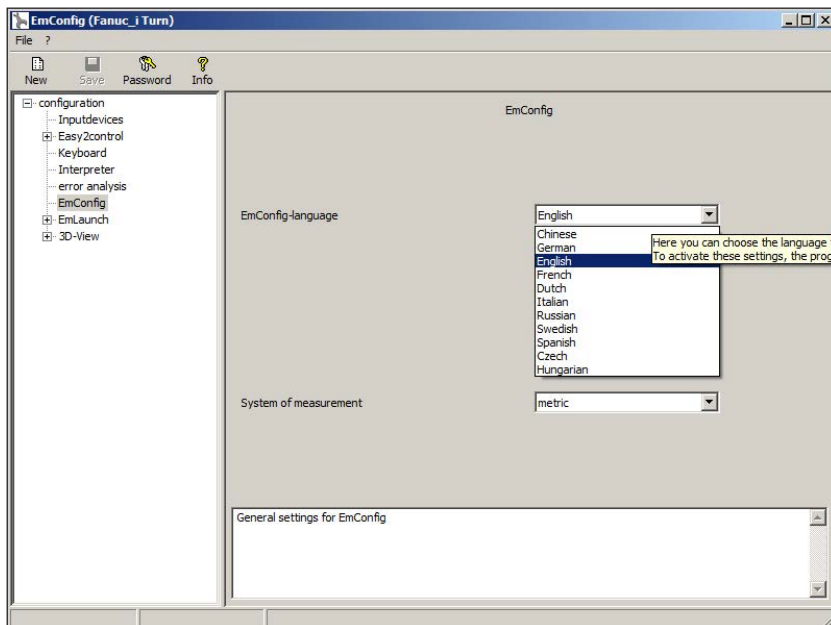

Change the language of EMConfig

Here you can change the language of EMConfig. In order to activate the settings, restart the program.

Note:

Select the desired menu item. The appropriate function is explained in the text box.



How to activate accessories

When you install accessories on your machine, you need to activate them here.

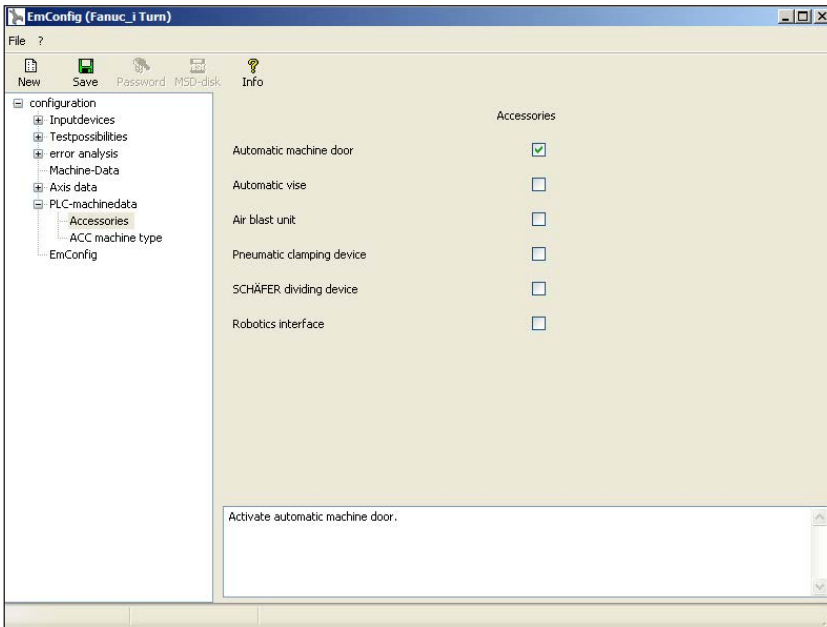

Activate accessories

High Speed Cutting

On activating this checkbox, High Speed Cutting is turned on.

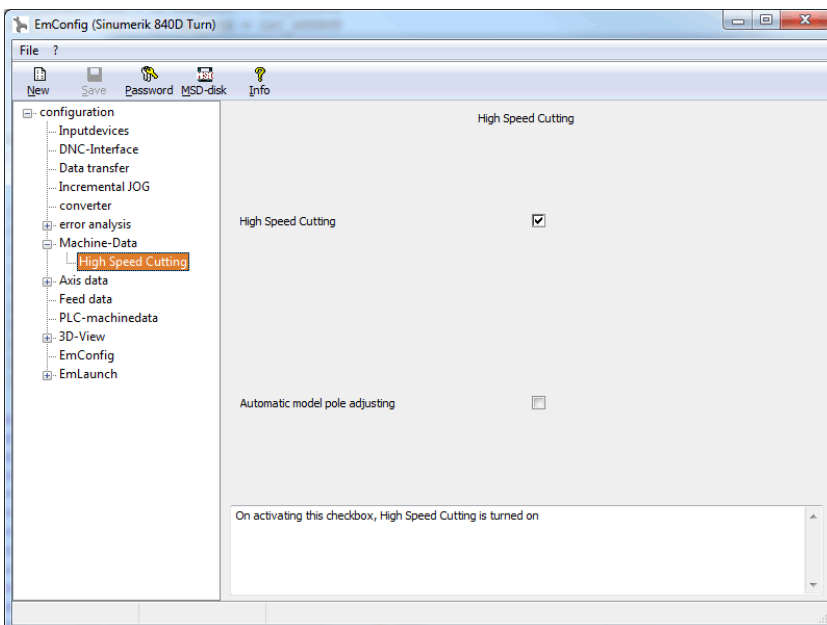

Activate High Speed Cutting

By using high speed cutting, the setting of the axis controller is adjusted. This gain is only effective until the programmed feed rate of 2500 mm/min and allows contour faithful retraction of the tool path and generating of sharp edges. If the feed is set up to higher than 2500 mm/min, it is automatically reset to the normal operating mode and sanded and rounded edges are created.

Easy2control on screen operation



Note:

If Easy2control is used after demo version without the hardware dongle or a valid license key, the controls are deactivated and an appropriate alarm is output by the controller. However, the virtual keyboard is displayed completely.

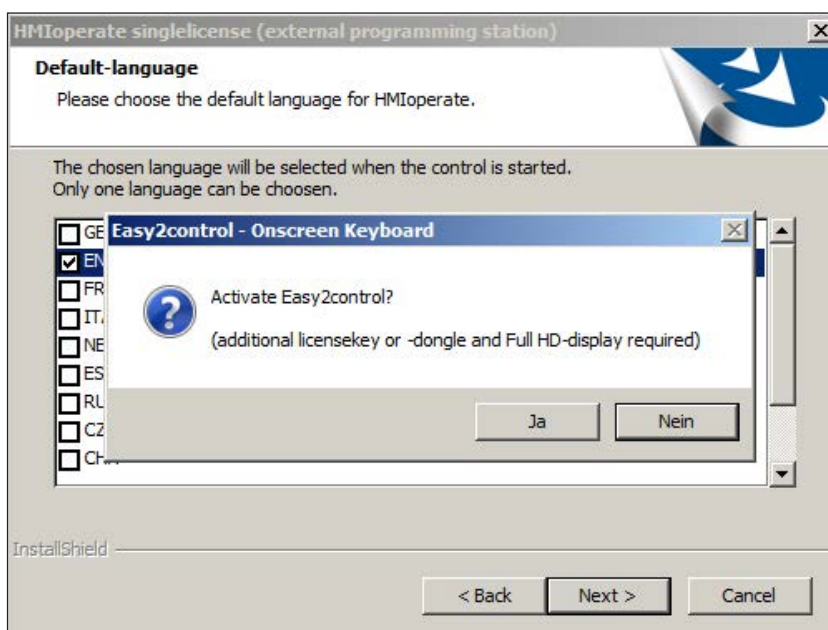

Activating Easy2control

When installing the software WinNC you will be prompted to activate Easy2control. In order to use the Software for a programming station without restriction, the license key must be entered or the license dongle supplied must be connected to a free USB port.

For lathes and milling machines of the Concept series 55/60/105 with connected Easy2Operate keyboard no license dongle is necessary.

Using Easy2Operate on a programming station requires either

- a license dongle, or
- a license key, or
- a connected Easy2Operate keyboard.

Easy2control settings

This mask allows you to enable or disable Easy2control and make settings.

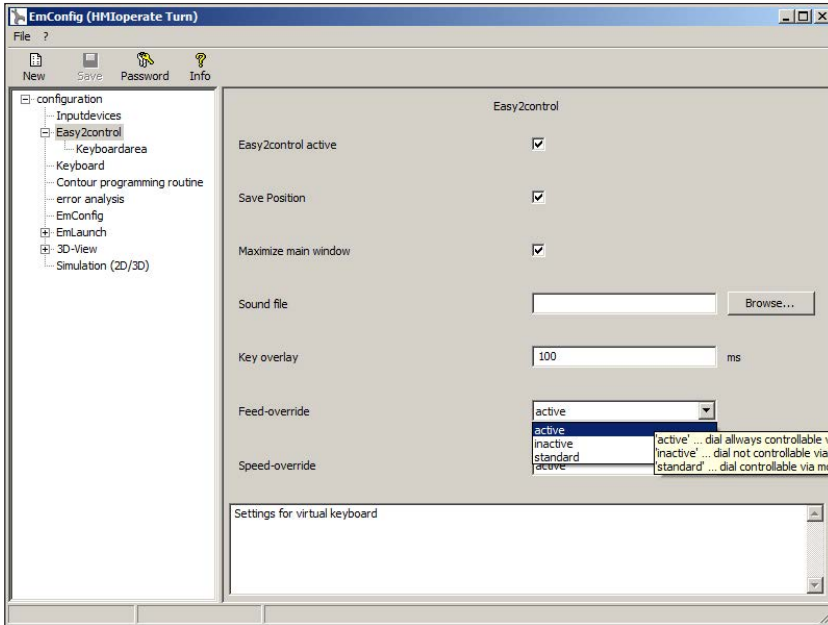

Dial feed-override and dial speed-override:

- **Active:** dial always controllable via mouse/touchscreen (even with available hardware-version).
- **Inactive:** dial not controllable via mouse/touchscreen.
- **Standard:** dial controllable via mouse/touchscreen when no hardware-version is available.

Easy2control settings



Danger:

Make sure the machine room camera is placed properly in the work area that collisions with the tool turret and the axes are avoided.

Machine room camera

The accessory machine room camera is available for all controls which support Easy2control.

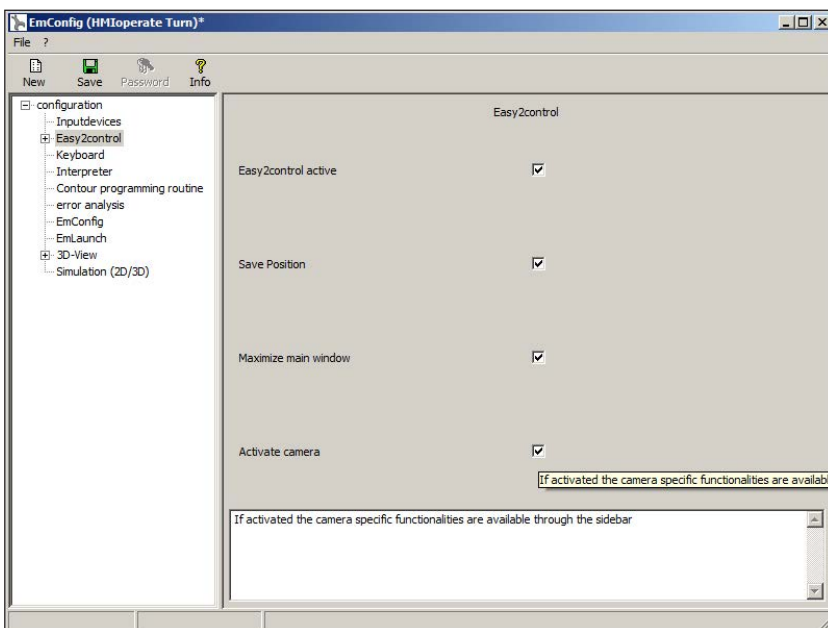

Activate camera

Please refer to chapter Y “external input devices” for more information about the installation guide for the the camera.



Attention:

The camera may not be operated without the supplied waterproof case.

If the camera is operated without the waterproof case it may be damaged by coolant and chips.

Input devices

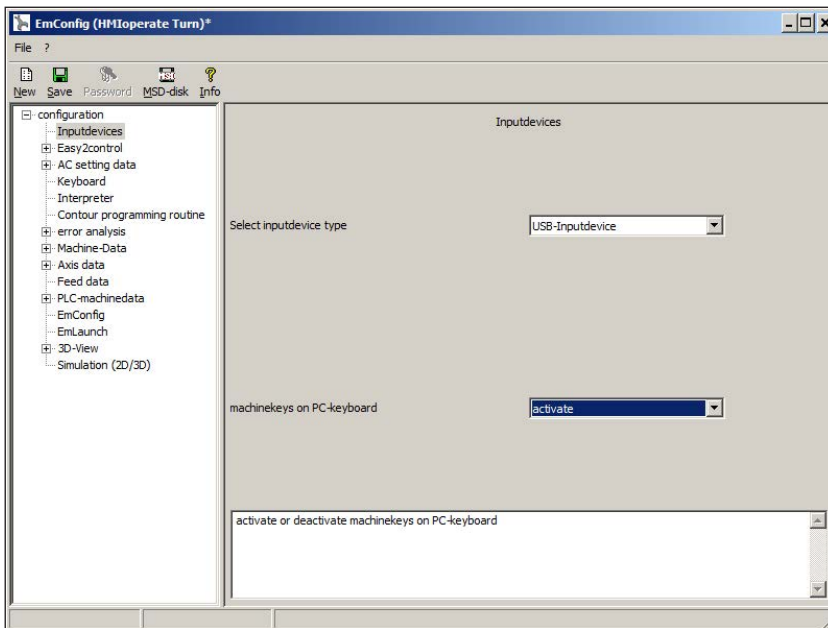

Settings for the input devices

- **Select input devices**
select the keyboard type.
- **Machinekeys on PC keyboard**
the keyboard can be activated or deactivated.

The setting is available for the following controls:

- EMCO WinNC for Sinumerik Operate
- EMCO WinNC for Fanuc31i
- EMCO WinNC for Heidenhain TNC640
- CAMConcept

How to save changes

After the settings, the changes must be saved.

Select "Save" or click on the icon.

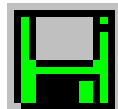

Note:

Input fields highlighted in red indicate inadmissible values. Inadmissible values are not saved in EMConfig.



After saving the changes, create a machine data floppy disk (MSD) or a machine data USB flash drive.

How to create machine data floppy disk or machine data USB flash drive

After having changed the machine data, the machine data floppy disk or the machine data USB flash drive must be in the appropriate drive. Otherwise your changes cannot be saved and get lost.

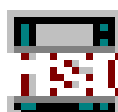

Y: External Input Devices

Easy2control On Screen operation

Easy2control adds a range of attractive applications to the successful interchangeable control system used in EMCO training machines. Suitable for use in machines and simulation workplaces alike, it displays additional control elements directly on the screen and, when used together with a touchscreen monitor, provides the ideal input interface.

Scope of supply

The software for Easy2control is part of the control software.

Single license:	Best. Nr.: X9C 120
Multiple license	Best. Nr.: X9C 130

Technical data for the screen:

16:9 Full-HD Monitor (1920x1080) at the minimum

Currently available controls (T and M):

- EMCO WinNC for Sinumerik Operate
- EMCO WinNC for Fanuc31i
- Emco WinNC for Heidenhain TNC 640 (M only)

A connected Easy2Operate keyboard unlocks Easy2control even without a separate license.

**Note:**

If a Full HD monitor is used without touchscreen function, the control is operated just with mouse and keyboard.

Operating areas

EMCO WinNC for Sinumerik Operate

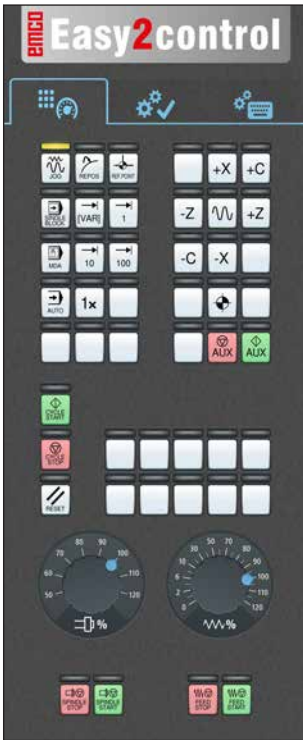

Machine control panel



Controller-specific operation



Control operation complete

EMCO WinNC for Fanuc 31i

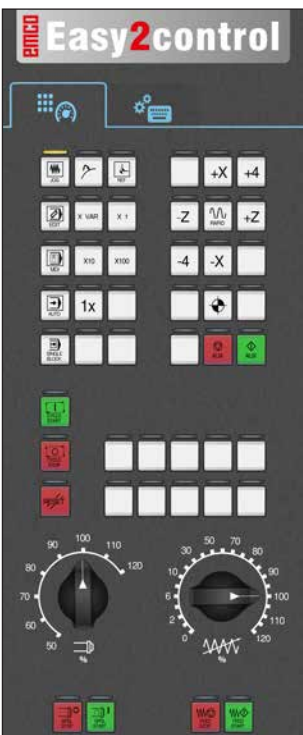

Machine control panel



Control operation complete

Emco WinNC for Heidenhain TNC 640



Machine control panel



Controller-specific operation



Control operation complete

Heidenhain TNC 426

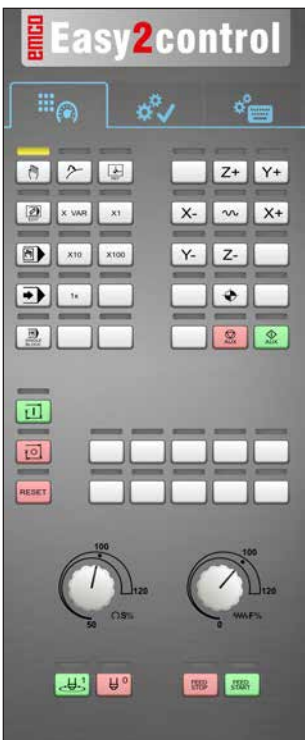

Machine control panel



Controller-specific operation



Control operation complete

Fagor 8055

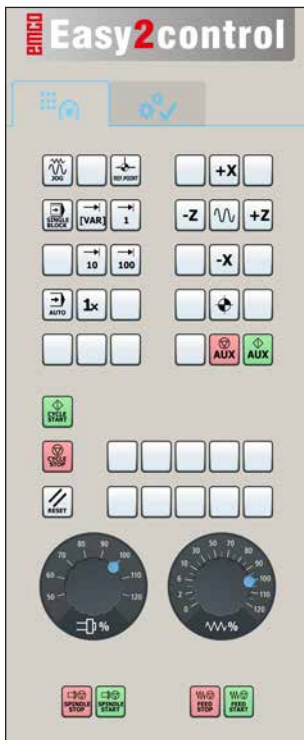

Machine control panel

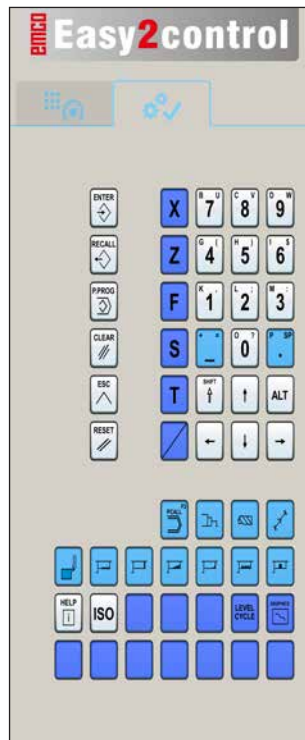

Control operation complete

Refer to the chapter “Key Description” of the respective control description for operation and key function.

Note:

The screen display, based on customer-specific configurations, may look different.



Machine room camera

This accessory is no longer available!

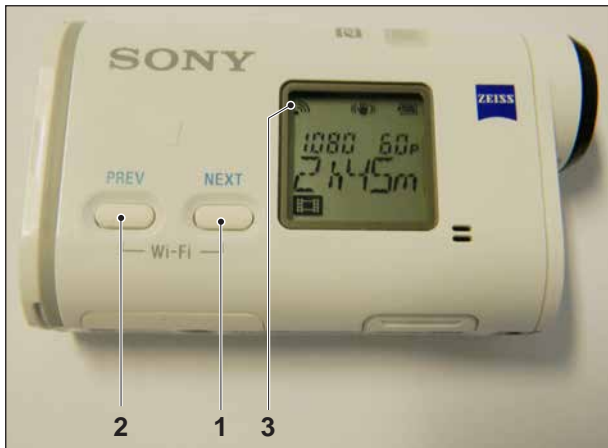

Activating WLAN



Connect WLAN

5 4

Installing the camera

Requirement

USB WLAN adapter for the machine.

Setup WLAN

- press NEXT (1) or PREV (2) until an operating mode appears which supports WLAN, e.g. MOVIE. The symbol for WLAN (3) appears in the corner on top left.
- Open EMConfig and activate the camera.
- Connect the WLAN adapter to the USB port to the machine.
- Open windows network and sharing centre (4).
- Select the wireless network, enter the password and finish the connect setup.
The name of the network (5) and the password are supplied together with the camera.
- Open the control software with activated Easy-2control.

Operating the camera

- Click the Easy2control logo to open the sidebar.

Functions of the sidebar

- Click the camera symbol to open the preview window (2).
- Open the operating manual of the control.
- Option for the second screen:
 - duplicate screen
 - screen extension to two monitors
- Creates a screenshot of the control in *.png format.

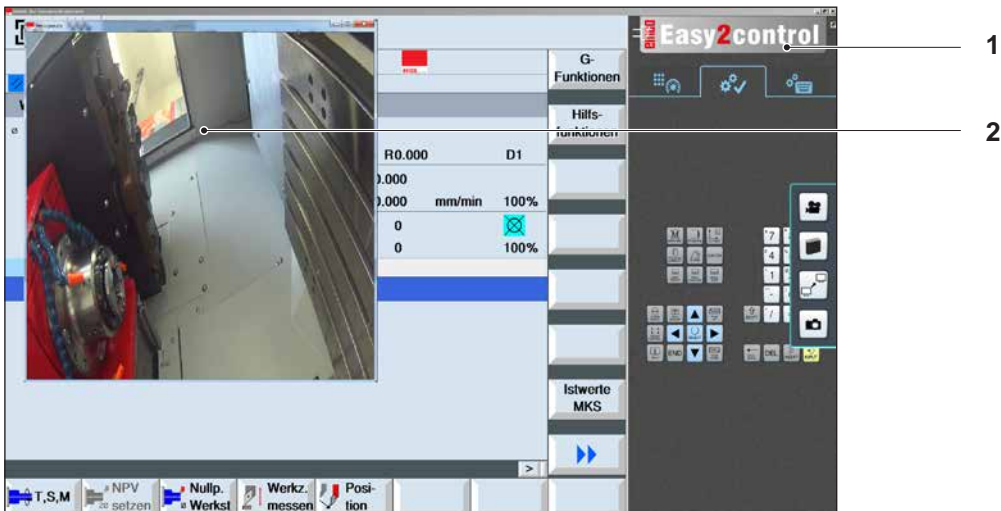

Operating the machine room camera

Note:

The option for the second screen is only available for machines CT/CM 260 and 460.



Attention:

The camera may not be operated without the supplied waterproof case.

If the camera is operated without the waterproof case it may be damaged by coolant and chips.



Z: Software Installation Windows

System prerequisites

Machine with integrated control PC

- All Concept machines
- Machines that were converted to ACC
- MOC with Windows 7 or higher (32 / 64 Bit)

Machines with included control PC and programming stations

- Windows 7 or higher (32 / 64 Bit)
- free hard drive space 400 MB
- Programming station: 1*USB, machine version: 2*USB
- TCP/IP-capable network card for machine version)

Recommended system prerequisites

- PC Dual Core 2 GHz
- Working memory 4 GB RAM
- free hard drive space 2 GB
- Interface:
Easy2Operate: 1x USB for machine keyboard
Machine connection:
1x LAN (cable connection), only for machine licence
optional: LAN or WLAN for network connection

Software installation

- Start Windows
- Start the installation application on the USB stick or your download file.
- Follow the instructions from the installation guide.

For more informations regarding software installation and / or software update please refer to the documentation "short description for WinNC update installation".

Variants of WinNC

You can install EMCO WinNC for the following CNC control types:

- EMCO WinNC for Sinumerik Operate T and M
- EMCO WinNC for Fanuc31i T and M
- EMCO WinNC for Heidenhain TNC640
- HEIDENHAIN TNC 426
- FAGOR 8055 TC and MC
- CAMConcept T and M

In case there are several control types installed, a menu appears when starting EM Launch from which you can select the desired type.

The following versions can be installed from the WinNC variants:

- Demo licence:
The demo licence is valid for 30 days after the first use. 5 days before the demo licence expires, you can enter another valid licence key (see licence manager)
- Programming station:
Programming and operation of the appropriate CNC control type is simulated by WinNC on your PC.
 - Single user licence:
Authorizes to external programming of CNC-controlled machine tools on one PC workstation.
 - Multi-user licence:
Authorizes to external programming of CNC-controlled machine tools. The multi-user licence can be installed on an unlimited number of PC workstations or in a network within the institute registered by the licensor.
- Educational licence version:
Is a time-limited multi-licence especially for schools and educational institutes.
- Machine licence:
This licence allows to directly operate a PC-controlled machine (PC TURN, Concept TURN, PC MILL, Concept MILL) of WinNC as if it was operated by an ordinary CNC control.

Note:

PC TURN and PC MILL have to be equipped with the conversion kit for ACC in order to operate EMCO WinNC.



**Danger:**

Removal and installation of the network card must only be carried by skilled personnel. The computer must be disconnected from the power supply (pull the power plug).

**Note:**

During a machine installation one network-card is reserved exclusively for the control of the machine.

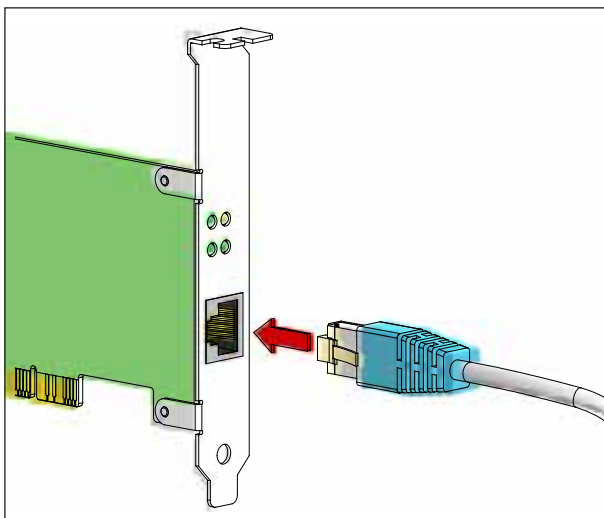

Connection of the machine to the PC

Network card (ACC)

for:

Concept Turn 55
 Concept Mill 55
 Concept Turn 105
 Concept Mill 105
 Concept Turn 60

Only for machines with ACC kit:

PC Turn 50
 PC Mill 50
 PC Turn 100
 PC Mill 120

Network card type: TCP/IP compatible network card

Setting the network card for the local connection to the machine:

IP address: 192.168.10.10
Subnetmask 255.255.255.0



In case of problems observe the instructions of your operating system (Windows help).

Instructions:

If the network connection to the machine could not be established at the start, the above adjustments are to be made.

Starting WinNC

If you choose AUTO START YES during the installation of your machine version, WinNC starts automatically after switching on the PC.

Otherwise proceed as follows:

- 1 Switch the machine on.
- 2 Wait for 20 seconds to ensure that the machine operating system is running before the network connection to the PC is established. Otherwise it is possible that no connection can be established.
- 3 Switch the PC on and start Windows.
- 4 Click on the start symbol at the bottom.
- 5 Select program, the installed folder, and start WinNC Launch.
- 6 The start image will be shown on the screen. The licence holder is registered in the start screen.
- 7 If you have only installed one CNC control type, it starts immediately.
- 8 If you have installed several CNC control types, the selection menu appears.
- 9 Select the desired CNC control type (use cursor buttons or mouse) and press ENTER to start it.
- 10 If you use the control keyboard, you can select the desired CNC control type with the cursor buttons or mouse and start with the "NC-Start" button.
- 11 Tool Buttons (1) can be configured in EMConfig.



Selection menu EMLaunch



Note:

EMLaunch displays all WinNC und CAMConcept controls that are installed in the same directory.



Terminating WinNC

- 1 Switch off auxiliary drive with AUX OFF.
Only for machine places, not for programming stations.
- 2 By simultaneously pressing these buttons WinNC for Sinumerik Operate will be terminated specifically.
This corresponds to Alt+F4 on the PC keyboard.

Checks by EmLaunch

An incorrect IP address was entered, the connection to the machine cannot be established.

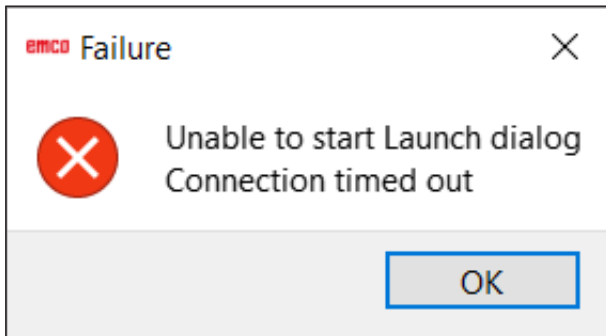

Connection to the machine failed

It is attempt to configure the IP address automatically via DHCP.



IP-address configuration

In the ACC / ACpn-machine version EmLaunch is checking if a machine is available:

During the network configuration, the IP address is not configured correctly and DHCP for automatic configuration of the IP address is disabled. Connection to the machine is not possible.

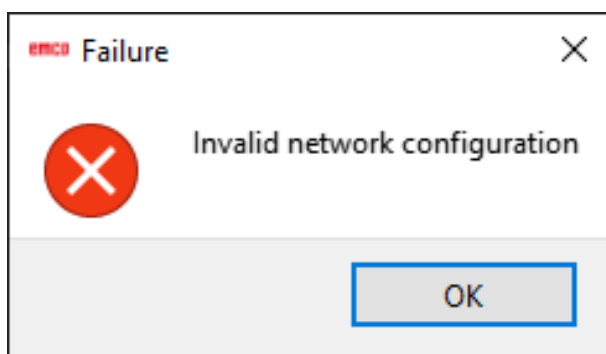

Network connection is not possible



Connection to the machine is OK

The connection to the machine is completed and the corresponding control can be started.

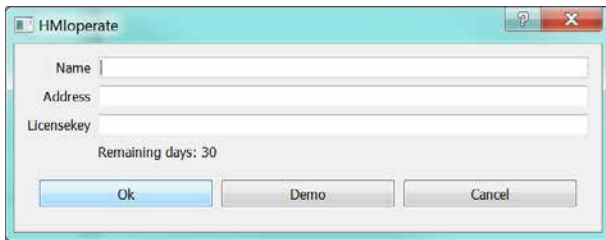

Input window licence key enquiry

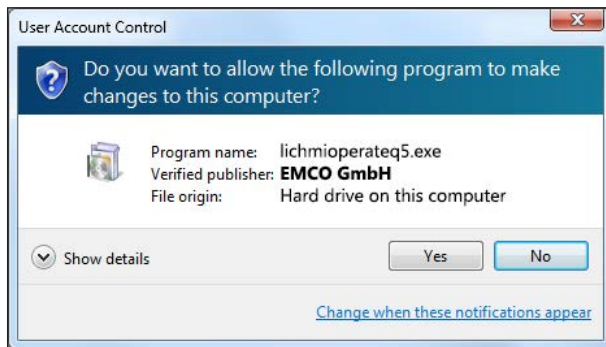

Run EMCO licence manager upon licence key input

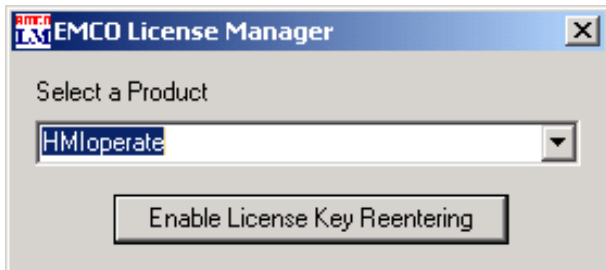

EMCO Licence Manager

Licence input

After the installation of an EMCO software product, an input window appears during initial operation and asks for name, address and licence key. If an Emco USB-Stick is connected, this data is taken from the USB-Stick.

UAC dialogue appears upon saving licence input. In order to complete the licence input successfully, the dialogue must be confirmed.

This input window appears for every software product that is installed. In case a demo licence is desired (see page Z1), please select "DEMO". Then the input window reappears only 5 days before the expiry date of the demo licence. A subsequent input of a licence key is also possible via the licence manager (see licence manager below).

Licence manager

For the release of additional function groups of existing EMCO software products it is necessary to enter a new licence key (exception: demo licence).

The EMCO Licence Manager enables the input of further new licence keys. For this purpose select the new product in the selection window and confirm the input.

The next time you start your control software an input window appears and asks you to enter name, address and licence key.

Please note that the licence key is asked for each software product individually. The picture on the left shows e.g. the input prompt for the licence key for the software product "HMIoperate".